

Pentagonal

Time Cycle Theory

[WWW.TRADING-SOFTWARE-COLLECTION.COM](http://WWW.TRADING-SOFTWARE-COLLECTION.COM)

**[WWW.FOREX-WAREZ.COM](http://WWW.FOREX-WAREZ.COM)**  
**[ANDREYBBRY@GMAIL.COM](mailto:ANDREYBBRY@GMAIL.COM) SKYPE: ANDREYBBRY**

Bradley F. Cowan

[www.trading-software-collection.com](http://www.trading-software-collection.com)

*Someone once said that time was a predator that snatched us all our lives,  
but I rather believe that time is a companion that goes with us on the  
journey, and reminds us to cherish every moment because they'll never  
come again.*

*... Picard, Star Trek*

**WWW.TRADING-SOFTWARE-COLLECTION.COM**










# Contents

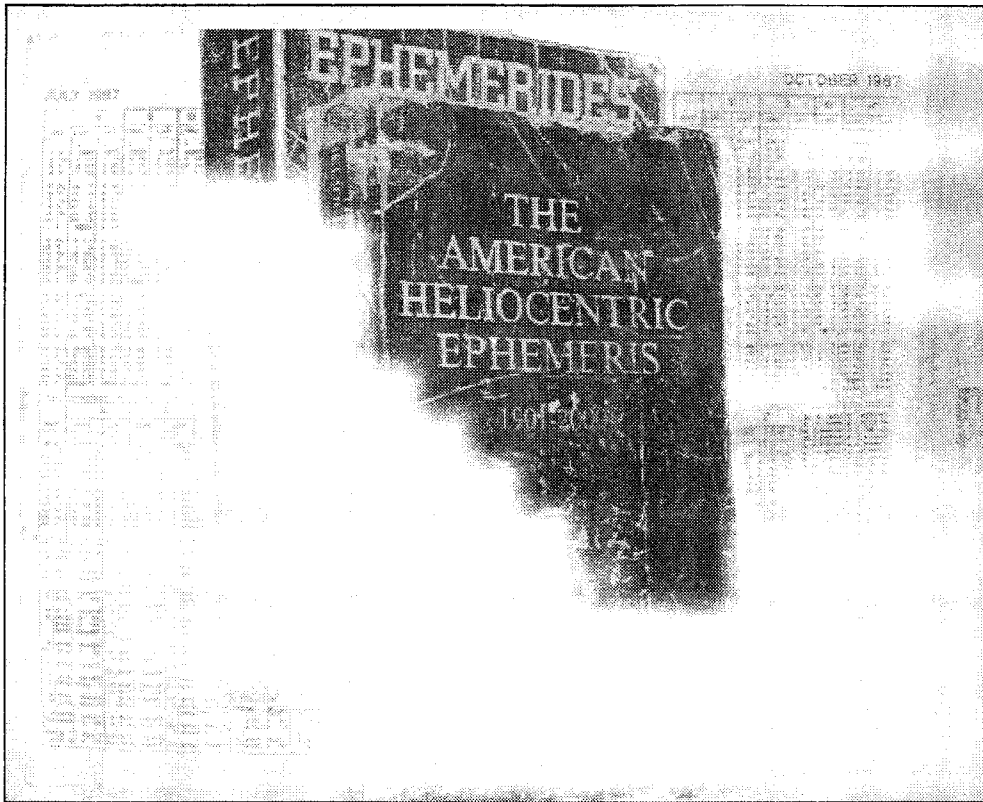
Terminology And Symbols Used In This Book .....	i
Introduction .....	1
<b>CHAPTER</b>	
<b>1 - THE 17-YEAR STOCK MARKET CYCLE .....</b>	<b>7</b>
REVIEW OF THE 17-YEAR CYCLE 1792-1914 .....	7
REVIEW OF THE 17-YEAR CYCLE 1914-2017 .....	8
INVESTMENT STRATEGIES MUST BE ADJUSTED FOR 17-YEAR CYCLES .....	10
<b>2 - THE GOLDEN TRIANGLE, TRIPLE TRIANGLE, &amp; SQUARE OF TWELVE .....</b>	<b>13</b>
THE GOLDEN TRIANGLE .....	13
<b>3 - THE URANUS PENTAGRAM .....</b>	<b>17</b>
URANUS .....	17
THE URANUS TRIPLE TRIANGLE .....	18
POSSIBLE ORIGIN OF THE URANUS PENTAGRAM .....	22
TIME CYCLE TRIANGULATION .....	23
<b>4 - MID-CYCLE PANICS AND THE LAW OF ALTERNATION .....</b>	<b>27</b>
MID-CYCLE PANICS AND ALTERNATING URANUS PENTAGRAMS .....	29
THE MID-CYCLE PANIC OF 1973-1974 .....	29
THE MID-CYCLE PANIC OF 2007-2009 .....	33
PEARL HARBOR AND THE PANIC OF 1981 .....	35
THE KOREAN WAR AND THE 1906-1907 "RICH MAN'S PANIC" .....	37
CONCLUSION .....	38
<b>5 - MID-CYCLE BOTTOMS AND THE LAW OF ALTERNATION .....</b>	<b>41</b>
THE 1924 ACCELERATION BOTTOM .....	41
THE 1958 ACCELERATION BOTTOM .....	41
THE 1988 AND 1994 ACCELERATION BOTTOMS .....	41
<b>6 - URANUS 18<sup>0</sup> HARMONICS IN THE DJIA 1897 – 2007 .....</b>	<b>47</b>
URANUS 18 <sup>0</sup> HARMONICS BETWEEN 1998-2012 .....	47
URANUS 18 <sup>0</sup> HARMONICS BETWEEN 1980-1995 .....	49
URANUS 18 <sup>0</sup> HARMONICS BETWEEN 1966-1981 .....	49
URANUS 18 <sup>0</sup> HARMONICS BETWEEN 1950-1962 .....	50
URANUS 18 <sup>0</sup> HARMONICS BETWEEN 1937-1950 .....	51
URANUS 18 <sup>0</sup> HARMONICS BETWEEN 1897-1933 .....	52
<b>7 - WHEELS WITHIN WHEELS .....</b>	<b>53</b>
SATURN-URANUS HARMONY .....	53
SATURN-URANUS SYNODIC CLOCK .....	53
ELLIPTICAL ORBITS CAUSE SYNODIC CYCLES TO VARY .....	55
SATURN-URANUS AND THE 17-YEAR CYCLE .....	55
SYNCHRONIZING SATURN-URANUS WITH THE URANUS PENTAGRAM .....	58

TIMING THE 2000-2017 CYCLE WITH SATURN-URANUS .....	61
TIMING THE 1966-1982 CYCLE WITH SATURN-URANUS .....	64
SATURN-URANUS MOVEMENT BETWEEN FOUR 17-YEAR CYCLES .....	67
REAL-TIME EXAMPLE OF TRADING THE SATURN-URANUS CYCLE .....	67
THE SATURN WHEEL .....	72
THE SATURN GOLDEN TRIANGLE .....	80
THE SATURN PENTAGRAM 1897-1982 .....	82
SATURN 36 <sup>0</sup> HARMONICS .....	82
<b>8 - FIBONACCI 13-8-5 YEAR CYCLES .....</b>	<b>85</b>
THE 13-YEAR CYCLE .....	85
50-YEAR PERIOD OF "JUBILEE" .....	86
THE URANUS PENTAGRAM AND THE 13-YEAR CYCLE .....	91
THE "MARK OF THE BEAST" CYCLE OF 666 WEEKS .....	93
PENTAGONAL EARTH-VENUS CYCLES .....	95
FIRST AND SECOND-ORDER EARTH-VENUS CONJUNCTIONS .....	95
FIRST AND SECOND-ORDER EARTH-VENUS RECURRENCE CYCLES .....	98
THE FOURTH SQUARE OF TWELVE AND THE EARTH-VENUS CYCLE .....	101
APPLICATIONS OF EARTH-VENUS CYCLES IN THE STOCK MARKET .....	102
FIBONACCI PARTITIONING 13-YEAR CYCLE INTO 8 AND 5 YEARS .....	107
GANN'S 5-YEAR 2-1-2 PATTERN .....	108
<b>9 - THE GREAT PENTAGRAM .....</b>	<b>115</b>
BIRTH OF THE NYSE AT THE BUTTONWOOD AGREEMENT .....	116
ADDING MARS TO THE 666-WEEK BEAST CYCLE .....	117
THE CAUSE OF THE CRASH OF 1962 .....	118
THE CAUSE OF THE CRASH OF 1974 .....	119
THE CAUSE OF THE CRASH OF 1987 .....	120
TRIPLE TRIANGLE OF 1962, 1974, 1987 .....	121
THE MATHEMATICAL BASIS OF THE 666-WEEK BEAST CYCLE .....	122
INTEGRAL MULTIPLES OF 144 <sup>0</sup> ALIGN ORBITS WITH BEAST CYCLE .....	123
THE PANIC OF 1984 .....	126
MORE CYCLES THAT WERE USED TO CALL THE MARCH 2009 BOTTOM .....	127
GRAND CONJUNCTION OF 1897 .....	130
1914 START OF WORLD WAR I .....	131
GREAT DEPRESSION OF THE 1930s .....	132
TRIPLE TRIANGLE OF 1897, 1915, 1933 .....	133
EARTH-VENUS AND SATURN-URANUS FORM PENTAGONAL FRACTAL PATTERN .....	134
<b>10 - RECURRING MARKET PATTERNS .....</b>	<b>137</b>
EXPANDING PENTAGONAL ENERGY LEVELS .....	137
PENTAGONAL EXPANSION OF URANUS TO EQUINOX PRECESSION CYCLE .....	138
EARTH-VENUS IS A PENTAGONAL TIME FRACTAL OF SATURN-URANUS .....	139
PENTAGONAL EXPANSION OF VENUS TO THE 666-WEEK BEAST CYCLE .....	140
PENTAGONAL DECOMPOSITION IN THE ANCIENT TEMPLE OSIRION .....	140
SAROS CYCLE .....	141
THREE-DIMENSIONAL PERSPECTIVE OF PENTAGONAL CYCLES .....	144
EXAMPLE OF EXPANDING PENTAGRAMS AT HIGHER ENERGY LEVELS .....	145
FORECASTING TIME INTERVALS BETWEEN REPEATING PATTERNS .....	145
THE 1924-1939 MARKET PATTERN REPEATED IN 1994-2009 .....	148
THE 1859-1886 MARKET PATTERN REPEATED IN 1924-1951 .....	151

THE 1897-1915 MARKET PATTERN REPEATED IN 1964-1983 .....	153
URANUS PENTAGONAL EXPANSION BETWEEN REPEATING PATTERNS.....	156
MARKET SYMMETRY OFTEN CAUSES INVERTED PATTERNS TO MATCH.....	157
<b>11 – COMMENTARY - COGAN'S RHYTHMIC CYCLES OF OPTIMISM AND PESSIMISM ....</b>	<b>161</b>
COGAN'S 17-YEAR STOCK MARKET PERIODICITY.....	161
EXAMPLES OF COGAN'S 17-YEAR PERIODICITY.....	162
CREATING A 10-CYCLE COMPOSITE WITHOUT USING A COMPUTER.....	164
INCORPORATING $\Delta$ SATURN= $180^{\circ}$ INTO COGAN'S MODEL.....	168
TIMING THE FIRST FIVE YEARS WITH $\Delta$ SATURN= $60^{\circ}$ AND GANN.....	168
INCORPORATING $\Delta$ SATURN= $36^{\circ}$ AND $60^{\circ}$ INTO COGAN'S MODEL.....	170
TIMING MID-CYCLE BOTTOMS WITH $\Delta$ SATURN= $120^{\circ}$ .....	172
EXAMPLE OF THE 17-YEAR MODEL IN THE NEGATIVE PHASE .....	174
ALIGNING COGAN'S MODEL WITH $\Delta$ SATURN= $36^{\circ}$ and $\Delta$ SATURN= $60^{\circ}$ .....	177
LOCATION OF THE 17-YEAR CYCLE AFTER 2000.....	177
PRICE AND PLANETARY DISPLACEMENT SQUARES .....	180
<b>CONCLUSION .....</b>	<b>181</b>
<b>APPENDIX</b>	
<b>A - RHYTHMIC CYCLES OF OPTIMISM AND PESSIMISM - RETYPED.....</b>	<b>185</b>
<b>B - RHYTHMIC CYCLES OF OPTIMISM AND PESSIMISM - ORIGINAL .....</b>	<b>223</b>
<b>C - THE DIVINE PROPORTION, PENTAGRAM STAR &amp; GOLDEN TRIANGLE .....</b>	<b>247</b>
<b>D - SQUARE OF TWELVE – W.D. GANN MASTER COURSE.....</b>	<b>253</b>
<b>E - STOCK MARKET NATURAL GROWTH EQUATION.....</b>	<b>257</b>
<b>F - PLANETARY ANGLES BETWEEN DATES .....</b>	<b>261</b>
<b>G - <math>\Phi^3</math> PENTAGONAL EXPANSION OF PLANETARY CYCLES.....</b>	<b>263</b>
<b>H - BOROBUDUR, JAVA AND THE SQUARE OF TWELVE.....</b>	<b>265</b>
<b>I - URANUS QUARTER-CYCLE STOCK MARKET UPDATE.....</b>	<b>269</b>
<b>J - URANUS TRINE. SOYBEAN CYCLE UPDATE.....</b>	<b>273</b>
<b>K - REPRINT OF COWAN'S 2003 MAGAZINE ARTICLE.....</b>	<b>275</b>

## Terminology And Symbols Used In This Book

Synodic cycle	The time between two successive planetary conjunctions. It measures the motion of one planet relative to another instead of the background of fixed stars.
Sidereal cycle	The period of a planet measured against the background of fixed stars. It involves one planet instead of two.
Saturn-Uranus	The synodic cycle of Saturn and Uranus, averaging about 45 years. Other synodic cycles will use this same type of hyphenation.
$\Delta$	Greek symbol for "delta", commonly used in mathematics meaning the change in a value. For example, " $\Delta$ Saturn-Uranus= $135^0$ " means "the change in Saturn's location relative to Uranus is $135^0$ ".
$\Delta$ S-U	Change in synodic angle between Saturn and Uranus. Sometimes used on a chart with limited space.
$\sigma$	Conjunction of planets, i.e., they are at the same zodiac location relative to the background of fixed stars.
$\infty$	Opposition of planets, i.e., they are $180^0$ from each other in the zodiac.
$\approx$	Approximately equal to. For example, $4 \approx 4.01$
$\sim$	About
	Mercury
	Venus
	Earth
	Sun
	Mars
	Ceres
	Jupiter
	Saturn
	Uranus



My old ephemeris, both geocentric and heliocentric, with interpolated data penciled in. For years these books rarely left my side and were rarely closed.

Yes, life has gotten much easier for market researchers since I wrote my first book. However, with all the technology that has changed and simplified our lives, the same cycles that dominated human behavior years ago are still present in today's markets. In fact, I will prove that these same cycles repeated 100 years ago when people got around in horse and buggy. I will do this by anchoring the origin of cycles back in 1914, and show they still hit turning points in today's market accurate to the day.

In 1914 the war that ultimately engulfed the entire developed world was just beginning in Europe. The state-of-the-art car was the Model T. The first heavier than air flight was barely eleven years old. Home electricity was a luxury and uncommon outside the cities, the 10<sup>th</sup> Cavalry was still

fighting the Indians in Arizona, and the sale and distribution of cocaine was legal and widespread.

So how can a cycle that repeats today have its origin back when life was so different, technology so primitive by today's standards, and communication so limited? The answer is because human instincts and behavior have not changed. Men still respond to the same instincts of hope, greed, fear, and the tendency to panic that they have since man first walked this Earth. With enough reliable data these cycles can be extended back in time to the birth of the market.

The biggest problem with an extended historical analysis of the stock market is that daily data was not recorded prior to 1885. In

## Introduction

Many years ago I was a young electrical engineer, fresh out of college and beginning my new fascination with financial markets and continuing an old fascination with time. I often listened to the stories of my work colleague who told me how he lost his life savings in the market years earlier and had gone back to work in his late 50s to make a living once again. This man will never know how much he influenced the future life of the young engineer sitting next to him. He was well read on many topics from trading stocks to proper nutrition and exercise. He loved talking about his World War II experiences in Italy where his job was going through the battlefield bayoneting enemy soldiers to be sure they were all dead. I have never been much of a talker, so I would sit and quietly listen to all his stories.

His market timing techniques were simple point-and-figure charts, but the concept of applying technical analysis was implanted in my brain like a seed that grew into a life-long study. I began my quest to find anything related to technical analysis, but soon found there was scarce material of true value on the subject. Therefore, I began my own research, applying my science and psychology background with a focused determination to find the order within the seemingly chaotic markets.

At that time the only way to trade was via telephone. So I would drive down to my local brokers office when they opened at 6am and stand there all day using their Quotron machines to get quotes. I was trading OEX (SP500) and XMI (Dow Jones) index options.

Every hour at the top of the hour I would get data points from the Quotron and hand draw them on my charts in the notebook I always carried with me.

It has been nearly seventeen years since I wrote my first book *Four-Dimensional Stock Market Structures and Cycles*. It is hard to believe how fast time went by and how things have changed. When I published my first book there was no Internet, no computerized ephemeris, no fast computers for easy charting and word processing. Now, I can do hundreds of calculations with the click of a mouse in the same time one calculation use to take with an ephemeris and hand-held calculator. Charts that are now effortlessly updated for me were drawn by hand or made with a slow spreadsheet, on an even slower computer with a small monochrome monitor. The endless hours spent driving to the local library for reference material is now delivered instantly to my desktop computer.

I still keep my old ephemeris books for nostalgia and as a reminder of how much hard work was needed to discover the things I published in my books and still use today in my trading. Held together with clear packing tape, these books traveled with me everywhere I went. Because the heliocentric ephemeris did not give the planets positions every day, I had to manually interpolate their locations between published dates every time a theory had to be tested, a very time consuming process. Now it's all done in an instant directly on my charts with software.



### Dates of Historical Stock Market Averages

14 Stock Average	1885
12 Stock Average	1886 - 1889
20 Stock Average	1890 - 1896
12 Industrials	1897 - 7/30/1914 (market close due to war in Europe)
20 Industrials	12/12/1914 (market reopen) - 10/1/1928
30 Industrials	10/2/1928 - Present

addition, between 1885 and the reopening in 1914 the composition of the index changed often and dramatically.

This book will primarily focus on the cycles after 1897, giving more than 100 years of data.<sup>1</sup>

The recent financial panic of 2007-2009 highlights how little we have learned from history. The Federal Reserve Bank (FRB) is still using many of the same archaic tools from decades past. When the crisis began the FRB was still holding interest rates higher than they should have. Many FRB governors incorrectly commented that inflation was the real concern, not the deflationary spiral that had already begun.

To gage the health of the economy they watched consumer spending and credit on mortgages and credit cards. Their thinking was that as in the past the consumer would default on credit cards first and their mortgage last. They were wrong. This time things were different because housing prices had already dropped and many owners were underwater with their mortgages, owing more than the house was worth. So they defaulted on their mortgages and walked

<sup>1</sup> Monthly close stock market data from 1790 to the present is available at [www.cycle-trader.com/stockmarket.htm](http://www.cycle-trader.com/stockmarket.htm) for testing cycles prior to the 1900s.

away from their house. At the same time they kept their credit cards current because it provided short-term liquidity. The FRB had it backwards and starved the banks of much needed capital they would have gotten through lower interest rates. As real estate values continued to decline the banks balance sheets became so bad many were forced to close. When Lehman Brothers failed the market finally collapsed in September 2008. All of this could have been averted, or at least alleviated, if the FRB had recognized the problem earlier and dropped interest rates quickly and dramatically.

The cyclic tools taught in this book would have allowed the FRB to recognize that a panic was due and at least figure that probability into their decision-making equation. However, I do not expect that to happen any time soon. Maybe in another 100 years things will be different, but not likely.

Much of the material in this book was actually written by me years ago. I put it together shortly after publishing the *Market Science* set of books in 1995. However, I just became very tired of dealing with the public and returned to my private life. My time since then has been spent on my personal trading and traveling the world. Some years I spent more time outside the USA than home, visiting and studying old civilizations and temples in developing

countries. Often times I stayed in a simple beach bungalow with no electricity, running water, or people who understood English. I do not know what caused my interest in writing to return after all this time. Maybe it was the recent plunge in stock prices over the past year that caused me to dust off these old writings, update them, and if laziness or disinterest doesn't return, maybe even publish it this time.

As the title indicates, this book explores the use of the pentagram together with planetary cycles to time market turns. The pentagram has a rich history and was used extensively by Pythagoras in 600 BC, and even earlier. It has also been used as a symbol of malevolence or evil. Old religious groups associated the pentagram with the Beast or the devil and warned people to not explore its use. Religion is often used to manipulate behavior and those writing the religious laws often used astrology themselves. Much of their knowledge was kept very secret and revealed to only a handful of trusted colleagues. What better way could possibly exist to hide knowledge than to make the public believe that studying this knowledge is evil and would lead them away from God. Nothing could be further from the truth. I am just a nuts-and-bolts engineer trying to not limit myself with superstition, rather to explore wherever my calculations lead without prejudice.

When *Four-Dimensional Stock Market Structures and Cycles* was published in 1993 the stock market had been advancing for 11 years and was on the verge of a major acceleration point in 11/1994 that caused prices to spike into the double tops in 2000 and 2008. In this book I will show the cause of this powerful trend and where we are now in the current cycles. As in the earlier books, heliocentric planetary positions will be correlated with market cycles. Geocentric

data produces too many repeat angles due to apparent retrograde motion. For example, the Chart I.1 shows the geocentric Jupiter-Saturn cycle advanced  $120^{\circ}$  from 1941. The first recurrence of this cycle repeated five times from 3/31/1948 until 12/9/1949, a period of 20 months. This lack of resolution makes geocentric analysis unacceptable for this work. Because heliocentric data has no retrograde motion there is only one recurrence of each cycle.

The out-of-print publication of L. Peter Cogan *The Rhythmic Cycles of Optimism and Pessimism* will be studied and is included in its entirety in the Appendix in both original and retyped formats.<sup>2</sup> There have been many good books written on the stock market and economic cycles but there are only a handful that really stand out as must-reads for technical analysis students. Cogan's book is not very big, only 54 pages, and not very well written. It can be difficult to follow sometimes and would probably flunk any test by professional writers. One advantage of being an engineer is that I have read many poorly presented papers, written by people more interested in doing their research than publishing their results. If you can be patient and study their writings you can find many jewels of thought and good pieces of the puzzle you are trying to assemble.

Cogan's book looks at the 17-year cycle in business trends and stocks. He tries to identify an underlying periodicity within those cycles and breaks it down into a composite of simple cycles, which works pretty well on a yearly basis.

In this book I will look deeper into the 17-year periodicity and show its pentagonal nature. Cogan briefly tried to explain parts of it with a Saturn-Uranus correlation. He

---

<sup>2</sup> Reference Appendices A and B.

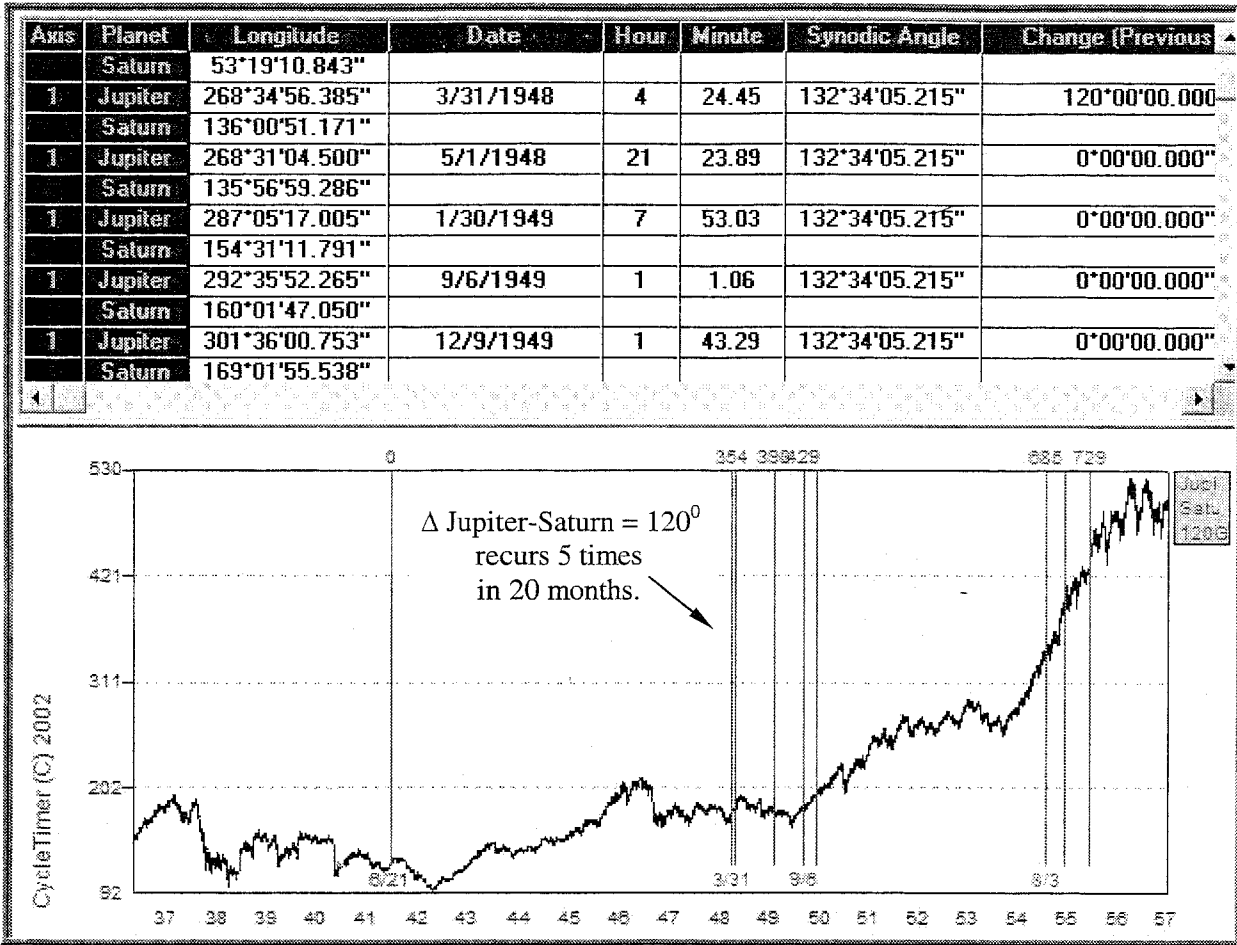


Chart I.1

Geocentric calculations produce many recurrences of the same cycle.

mentioned that it was 3/8 of the 45-year Saturn-Uranus cycle, or 135 degrees. This correlation is close, sometimes very close. However, there is a better explanation with a much higher correlation using daily market data that will be explored in this book.

Cogan’s writings, and mine, are directed toward a specific type of analyst. The person keenly interested in this type of material will be looking for the root cause of economic and stock market trends. They will be looking for the “how” and “why” markets move. This material is not directed toward the “accounting” type market analysts that study company balance sheets, profit/loss

statements, and other mind-numbingly boring topics typically found in the media such as CNBC or the Wall Street Journal. After about 10 minutes of listening to a stock analyst talk about company fundamentals I feel that I am either on the verge of being bored into a comma or thinking to hang myself to escape the monotonous torture.

Basing a trading or investing decision on something from the media is playing a fools game. The media has one interest, to maximize their audience size so they can increase their advertising rates as much as possible. They will do whatever it takes to

get you to watch or listen. CEOs habitually use the media to market their stock to the retail public. I remember when the CEO of Wachovia Bank, Steele, appeared on TV during the 2008 meltdown of the bank stocks. He enthusiastically stated with a straight face that Wachovia's at risk assets were "maybe as much as 5 billion dollars" and that Wachovia was not at risk in any way and would remain a solvent independent bank. A couple days later Wachovia released their records showing their bad loans totaled 123 billion dollars. Wachovia stock plunged and the bank was soon taken over by Wells Fargo. Are we to assume the CEO, Steele, did not know how bad the fundamentals of his bank were? Of course he knew. He was using CNBC to try to calm a potential bank run that had recently devastated other banks. But many retail investors got burned by watching that CEO lie about his companies fundamentals and made the foolish mistake of believing him.

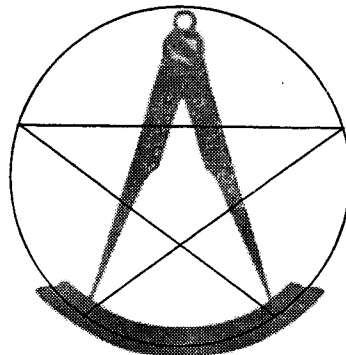
You can be sure that any information given to the media by a company representative is motivated by self-interest. What is the bottom line? Develop your own tools and use them. Everything else does more harm than good.

You will not find specific trading techniques this work. The intent is to show how to forecast the market trend. Anyone that cannot figure out how to trade a high probability predefined trend, should not be trading anyway.

Please note that I do not provide a private tutelage service or market advice for two primary reasons.

1. There are many readers of this material and it is simply impossible to answer questions.
2. I have had too many bad experiences with material I provided to others in confidence being published under their name.

I do not want the reader to waste his time writing email that will be unanswered.



# 1

## The 17-Year Stock Market Cycle

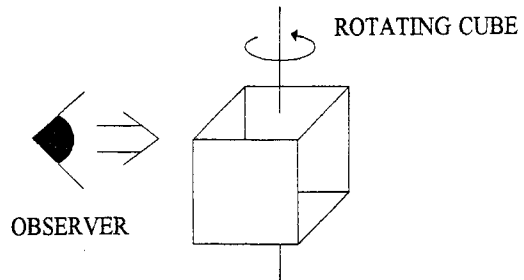
*Four-Dimensional Stock Market Structures And Cycles* presented a large geometric structure in the stock market in the form of a four-dimensional cube. Two-dimensional squares composing the sides of the cube were measured in price-time. The third dimension revealed these squares as sides of a rotating cube and the fourth dimension of time placed this entire structure in rotation along the x-axis (time) of a two-dimensional chart.

The duration of the sides of these squares were shown to be approximately 17 years and roughly correspond with the cycles identified in L. Peter Cogan's book, *The Rhythmic Cycles of Optimism and Pessimism*.

### REVIEW OF THE 17-YEAR CYCLE 1792-1914

Although unofficial trading was recorded in New York as early as January 1790, the commonly accepted birth of the New York Stock Exchange was at the signing of the Buttonwood Agreement on May 17, 1792. Chart 1.1 shows that since 1792 the 17-year cycle has repeated reliably with only a few minor deviations, such as the 15-year interval between 1792-1807. When the date of first trading is used, 1790, the rhythm is again 17 years. The occasional variations from the ideal 17-year rhythm will be explained in later chapters when the correlation with planetary cycles is studied.

Notice the lower support line connecting the bottoms from 1792 to 1859. All four 17-year cycles dropped down to this trend line until 69 years after Buttonwood when the Civil



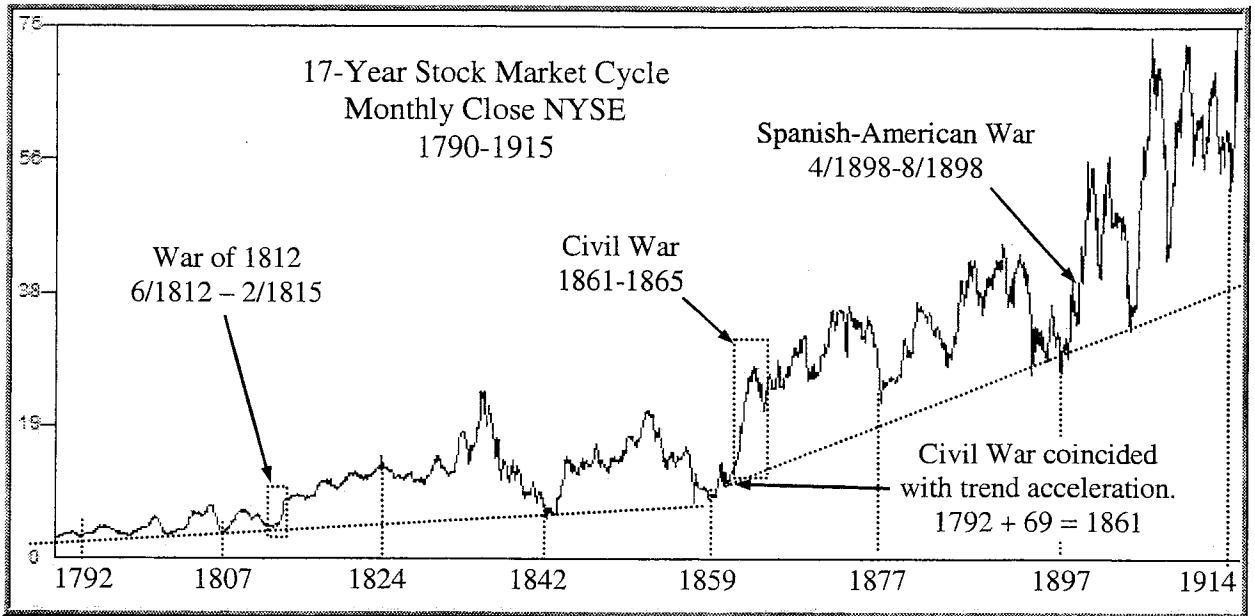
**Figure 1.1**

Cubic structure in the DJIA. From Lesson X in *Four-Dimensional Stock Market Structures And Cycles*.

War started in 1861. From that date forward the trend line moved up at an accelerated rate. Highly disruptive wars such as this often accelerate the rate of price appreciation as businesses increase capacity to fill the increased demand for war products. Similar conditions occurred in 1915 with World War I and in 1942 with World War II. On a smaller scale, the War of 1812 and Spanish American War in 1898 coincided with rapid stock market advances.

The time between the birth of the NYSE in 5/17/1792 and the closing of the market in 1914 was 122 years. Astrologers have known for centuries that 120 years is a major cycle corresponding with Uranus completing about 1½ cycles. Chart 1.1 shows there are seven 17-year cycles in the 120-year cycle.<sup>3</sup>

<sup>3</sup> In 1952 WD Gann wrote in his course *WD Gann Mathematical Formula For Market Predictions*, "The next number of greatest importance is 7, the number mentioned more times in the Bible than any number". Page 96 *Rare Writings of WD Gann*.



**Chart 1.1**

17-year cycle in New York stocks. 1790 to the close of the NYSE in 7/30/1914.

### **REVIEW OF THE 17-YEAR CYCLE 1914-2017**

Chart 1.2 shows four 17-year cycles in the DJIA between 1914 and 1982. The cycles followed a nearly ideal rhythm of alternating tops and bottoms with the exception of the 1932 bottom, which inverted due to the massive 5-year spike in prices, 1924-1929.

Chart 1.3 continues the 17-year cycle in the SP500 through 2017. In more recent times it is better to use SP500 data. The problem is the lack of historical data for this index. The NASDAQ is also a good index to use when data is available because it is the market leader in modern times. It is the young vibrant index drawing the majority of speculative energies, making it a much better reflection of impulsive mass human emotion.

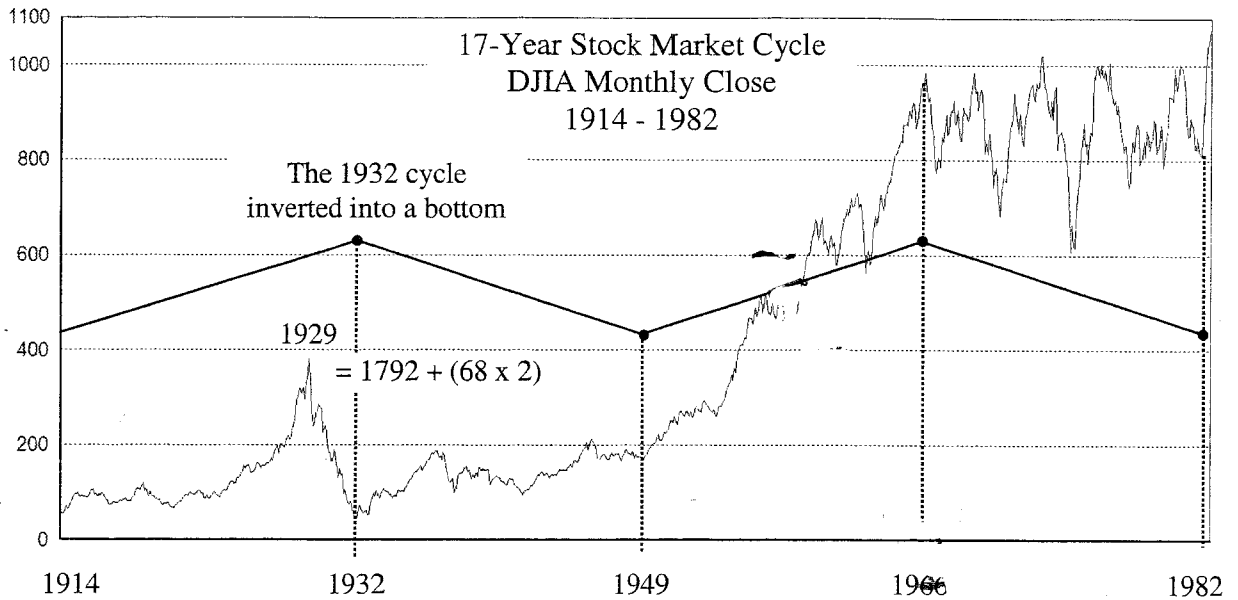
Table 1.1 shows that the average length of the six cycles between 1897 and 2000 was

17 years 1 month. 1897 will be later shown to be a major astronomical event realigning the cycles. It is the halfway point between the 1792 birth and the 2000 "dot com" top.

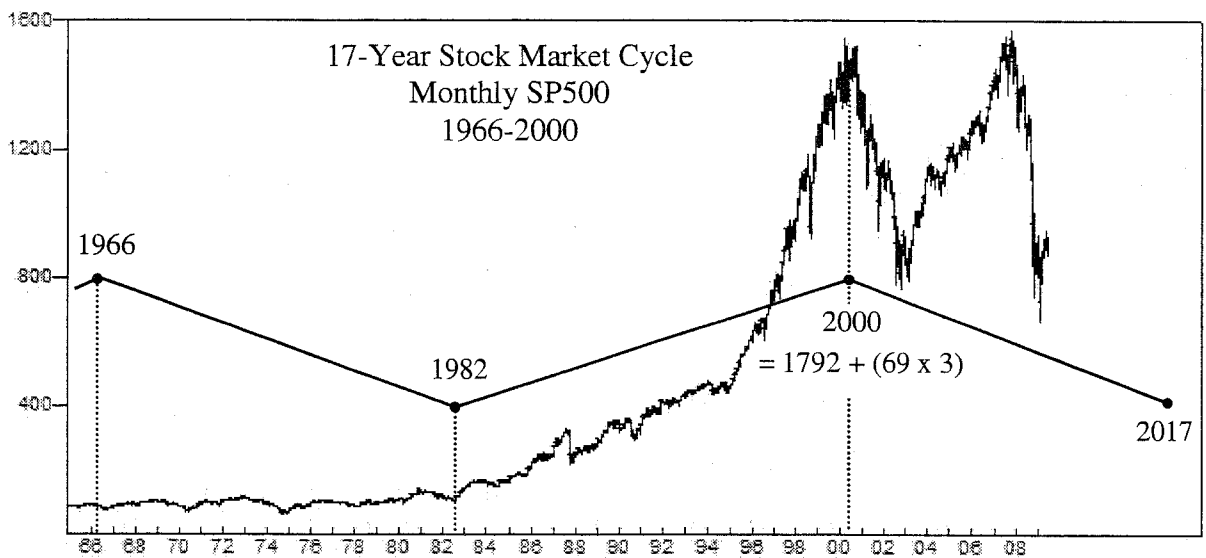
The 2000 top was a rolling top with different indices topping at different times. The DJIA ran out of buying energy in January but the NASDAQ continued its 1929 style hysteria to much higher levels in March before collapsing. The SP500 made a double top in March and September 2000.

Notice the multiples of 68 years from 1792 shown on these charts. The first one coincided with the Civil War, followed by the 1932 depression low, then the "dot com" bubble top in 2000. Later chapters will show that the speculative blow-off top in the NASDAQ in 2000 was the counterpart of the 1929 top in the Dow Jones.

**WWW.FOREX-WAREZ.COM**  
**ANDREYBBRV@GMAIL.COM SKYPE: ANDREYBBRV**



**Chart 1.2**  
 17-year cycle in the DJIA, 1914-1982.



**Chart 1.3**  
 17-year cycles in the SP500, 1966-2017.

©2009 COWAN

Beginning Date	Ending Date	Duration
8/9/1982	1/14/2000 (DJIA) 3/10/2000 (NASDAQ)	6,367 days = 17y 5m 5d 6,423 days = 17y 7m 1d
2/9/1966	8/9/1982	6,025 days = 16y 6m 0d
6/14/1949	2/9/1966	6,084 days = 16y 7m 26d
7/8/1932	6/14/1949	6,185 days = 16y 11m 6d
12/24/1914	7/8/1932	6,406 days = 17y 6m 14d
5/20/1897	12/24/1914	6,426 days = 17y 7m 4d
5/20/1897	1/14/2000 (DJIA)	Average of 6 cycles = 6,249 days ≈ 17y 1m ≈ 205 months

**Table 1.1**

17-year stock market cycles, 1897-2000

### **INVESTMENT STRATEGIES MUST BE ADJUSTED FOR 17-YEAR CYCLES**

17-year bull cycles last long enough to lull investors into a dangerous buy-and-hold complacency. At the end of the cycle investors and analysts who applied this strategy have done very well. The press is filled with articles that the best performing funds are typically the buy-and-hold value investors such as Warren Buffett of Berkshire Hathaway. Retail investors read these articles and try to follow the same strategy. They put their retirement accounts into stocks or funds and "forget about it". They have no experience suggesting they should do otherwise because every decline in the past 17 years was rapidly recovered as prices moved ever upward to new highs.

At the top of 17-year cycles, such as in 1966 and again in 2000, investors are overly confident. They have successfully applied the buy-and-hold strategy for years and see

no reason to worry, and neither does the press. They have no idea that for the next 17 years they will face many bone crushing bear markets that will devastate their accounts. Buy-and-hold investors often lose money for 17 years until the next cycle turns up.

Figure 1.2 shows a scan of part of a full-page ad placed by this author in late 1998 in the magazine *Technical Analysis of Stock And Commodities* warning that the 17-year cycle from late 1982 was ending and a major 3-year bear market would ensue. At the time no one was talking about a 17-year cycle, certainly not one that would be ending soon. The vast majority of traders and analysts were wildly bullish in the "dot com" speculative frenzy. To suggest a top was in sight during this time was very unusual.

History shows this forecast was correct with stocks topping in January 2000 and plunging 3-years in the "dot com" bust. The chapter



*Repeating Market Patterns* will show just how correct this forecast was by comparing the market action during the "dot com" boom and bust with its predecessor that unfolded four 17-year cycles years earlier, in the 1930s.

The second paragraph of this ad regarding the 17-year cycle is retyped below.

"There is a 17-year cycle in stocks that ends with a 3-year bear market. We have had these recessions (depressions) in 1912-1915, 1929-1932, 1946-1949, the 1963-1966 cycle inverted, and from 1979-1982. This cycle is particularly strong on the fourth recurrence, or every 68 years. Since the birth of the NYSE in 1792, this 68-year interval has happened at the start of the civil war in 1861, the great depression in 1929, and now. The 17-year cycle subdivides this 68-year interval into four parts. It is reaching a

critical turning point that will soon cause a significant bear market. Compounding the problem on the fundamental side is the fact that the Fed chairman has no clue what is happening or what to do. Last month he stated "The low unemployment numbers will inevitably put upward pressure on wages, reigniting inflation". A few weeks later he stated "deflation is a major concern". Which is it Mr. Greenspan, inflation or deflation? This is the man controlling short-term interest rates. Learn from history. **PROTECT YOUR ASSETS!**" ...Published in late 1998

The buy-and-hold strategy works best when it is applied at the start of 17-year bull cycles such as 1949, 1982, and 2017. Portfolios must be reallocated during 17-year down cycles to a much higher percentage of cash or bonds.

## IS THE BULL DEAD?

**Do any of your advisors have the slightest clue? The Elliott Wave "experts" predicted its demise in 1986.**

Before the October stock market decline we published our prediction in this magazine that the market was about to get hit hard TWICE. This prediction was made even though stocks had only one minor decline in the previous three years! The October drop was hit number one. Those who already have this material know how to predict these declines because their cause is shown on charts VIII.S, VIII.T, and VIII.H. This is the same cause that predicted the January 1990, July 1990, April 1994, and November 1994 declines (among others). **LEARN HOW TO MAKE THESE ACCURATE PREDICTIONS! LEARN BEFORE YOU LOSE!**

There is a 17-year cycle in stocks that ends with a 3-year bear market. We have had these recessions (depressions) in 1912-1915, 1929-1932, 1946-1949, the 1963-1966 cycle inverted, and from 1979-1982. This cycle is particularly strong on the fourth recurrence, or every 68 years. Since the birth of the NYSE in 1792, this 68-year interval has happened at the start of the civil war in 1861, the great depression in 1929, and now. The 17-year cycle subdivides this 68-year interval into four parts. It is reaching a critical turning point that will soon cause a significant bear market. Compounding the problem on the fundamental side is the fact that the Fed chairman has no clue what is happening or what to do. Last month he stated that "the low unemployment numbers will inevitably put upward pressure on wages, reigniting inflation". A few weeks later he stated that "deflation is a major concern". Which is it Mr. Greenspan, inflation or deflation? This is the man controlling short-term interest rates. Learn from history. **PROTECT YOUR ASSETS!**

**Figure 1.2**  
Magazine ad in late 1998 warning of a 17-year top.

# 2

## The Golden Triangle, Triple Triangle, And The Square Of Twelve

*Four-Dimensional Stock Market Structures And Cycles* explained that pentagonal or five-fold symmetry is only found in animate or living objects, not in static forms such as snowflakes or minerals. The human body shows pentagonal symmetry with five appendages to the trunk, two arms, two legs, and a head. On the ends of these arms and legs are five fingers and five toes.<sup>4</sup> As a historical record of human emotion stock market charts also demonstrate measurable pentagonal symmetry. Men in mass buy, sell, manipulate, cheat, lie, steal, scheme and deceive to the best of their abilities to fulfill their predatory instincts of self-survival and wealth attainment. Man by nature is a highly efficient predator. His two eyes are narrowly focused together and pointing to the front to seek prey as with the falcon and lion. Less predatory animals, prey, have their eyes more to the side for a wider view to see the predators coming.

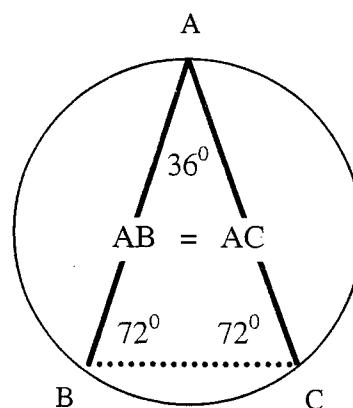
Stock market charts provide a record for a historical analysis of these modern high-tech human feeding frenzies. All the carnage is recorded there, the losers, the winners, the euphoria of success, the disappointment of broken dreams, the lives made, and lives shattered. It is all there recorded for centuries in day-by-day price fluctuations. This work will measure those records of lives made and broken with the same analysis tools, known as Sacred Geometry,

<sup>4</sup> "The Time Cycles and every measurement of angles are represented by the human body. You have 5 fingers on each hand...Note the 3 divisions of your fingers, and that the third joint or ends of your fingers are shorter than the other two..." *The Human Body*, WD Gann, 1931.

used to measure other dynamic living forms. At the foundation of Sacred Geometry is the Golden Ratio, Phi  $\Phi$ .

### THE GOLDEN TRIANGLE

The Golden Triangle is one of the geometric forms based on the Fibonacci ratio Phi, 1.618. It is an isosceles triangle, two sides of equal length, with an apex angle of  $36^\circ$ . Most readers of this book are familiar with Fibonacci and the Golden Ratio, so just a general introduction is provided here. The reader can find more material in many good books.<sup>5</sup> This book uses the Golden Triangle to construct the Triple Triangle, or pentagram.



**Figure 2.1**

The Golden Triangle is isosceles with equal sides separated by  $36^\circ$ .

<sup>5</sup> *The Divine Proportion*, H.E.Huntley, excerpt in Appendix C.

*Sacred Geometry*, Robert Lawlor.  
*Connections*, Jay Kappraff

One definitive characteristic of the Golden Triangle is that a bisector of one of the lower  $72^{\circ}$  angles drawn to the opposite side divides that side by the Golden Ratio,  $\Phi$ , forming a smaller Golden Triangle BDC.<sup>6</sup> The orientation of this smaller triangle is  $144^{\circ}$  from the larger triangle.

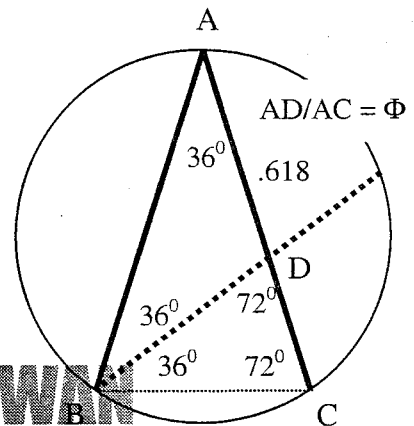
It is important these basic features of the Golden Triangle are understood because they will be referenced many times in this book. The dynamics between successive planetary arrangements at major market turns follow the Sacred Geometry of rotating Golden Triangles. At major market turns the inner planets form Golden Triangles in the same zodiac locations as the outer planets in a wheels-within-wheels arrangement.

The process of dividing the triangle into similar Golden Triangles can be continued down to an infinitely small triangle spiraling into an eye.<sup>7</sup> Sacred geometry and dynamic symmetry books refer to this continued creation of similar Golden Triangles as Whirling Triangles.

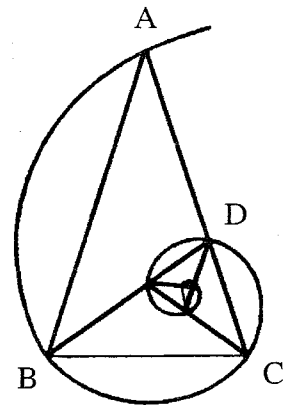
Similar triangles continue to spiral inward (or outward) with the Golden Ratio and each successive triangle apex  $144^{\circ}$  along the arc, point B is  $144^{\circ}$  from point A, and point C is  $144^{\circ}$  from B. The angle of rotation is important because it defines the orientation of the Triple Triangles or pentagram. In the zodiac these wheels-within-wheels spiraling Golden Triangles provide the timing for cycles ranging from years with the outer planets, to days with the inner planets, to minutes with the rotation of the Earth. The cosmos reveals a perfectly ordered clock when the mechanics of motion and Sacred Geometry are understood.

<sup>6</sup> Subdividing the Golden Triangle into similar triangles is shown in Huntley's book and in Appendix C.

<sup>7</sup> Reference, *Sacred Geometry*, Robert Lawlor.

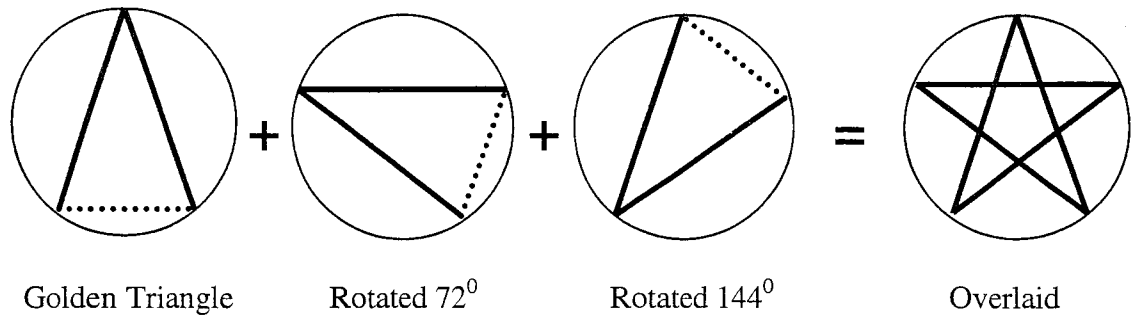


**Figure 2.2**  
Gnomonic division  
of the Golden Triangle



**Figure 2.3**  
Whirling Golden Triangles

Viewing the spiral of Whirling Triangles in three dimensions reveals a pyramid with a series of Golden Triangles rotating around a central core. The distance from the observer in three dimensions defines the apparent size of the triangle.



**Figure 2.4**

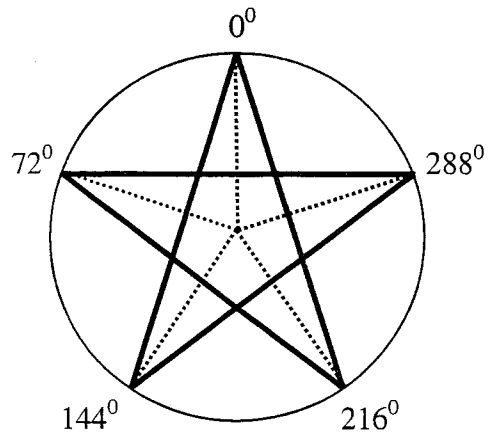
Three overlaid Golden Triangles form a Pentagonal Star, or Triple Triangle.

Figure 2.4 shows that rotating the Golden Triangle twice  $72^\circ$  forms the Triple Triangle, or pentagram.

The five points of the pentagram are separated  $72^\circ$  around the center. Equally important is that  $144^\circ$ , or the Square of Twelve<sup>8</sup>, define points on the same isosceles triangle composing the triple triangles, which are located at,

$$\begin{aligned} &0^\circ - 144^\circ - 216^\circ \\ &72^\circ - 216^\circ - 288^\circ \\ &0^\circ - 144^\circ - 288^\circ \end{aligned}$$

The Square of Twelve is derived from the pentagram because every other point on the pentagram is separated by  $144^\circ$ . These points also define the three Golden Triangles composing the pentagram.



**Figure 2.5**

$72^\circ$  separate the five pentagram points.

<sup>8</sup> Square of Twelve is intentionally capitalized as a proper noun, as in Gann's writings. Appendix D contains a lesson on the Square of Twelve from Gann's Master Courses, where he refers to it as one of the "Master Squares".

"Pentagons do not combine with themselves or other regular figures to fill space. Thus we find that crystals, which are repetitive assemblages of molecules, never have regular 5-sided faces. In fact, no inanimate form exhibits pentagonal symmetry. No regularly pentagonal snowflake has ever fallen from the sky. Only animate forms, complicated forms, structures beyond the interminable stacking of identical molecules, have shapes with five equal sides."

...Patterns in Nature, Peter S. Stevens, Professor of Architecture at Harvard

Mr. Stevens elegantly tells us that if a natural system is five-sided, or pentagonal, then it has the characteristics of an animate living body. This theme of animation in pentagonal symmetry was used in the first set of books in this series, where the dynamic nature of markets was measured and studied in detail.

It should be no surprise that the same pentagonal symmetry found in plants and animals is also found in the changing waves of mass human emotion that has been meticulously recorded for centuries in financial markets. The buying and selling of stocks provides an unmatched historical record of pooled human psychology.

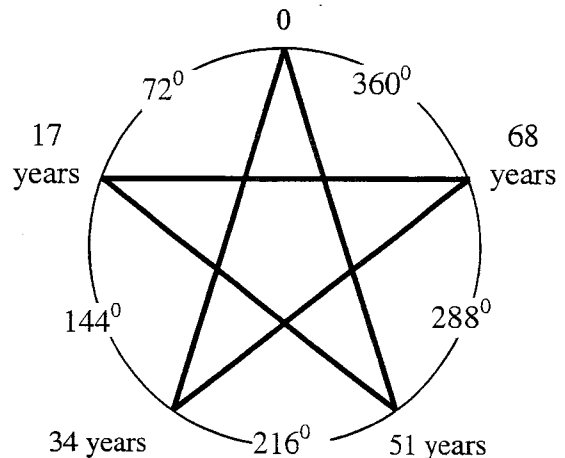
This chapter will use Uranus, the Greek "god of the sky", and market master, to explore the correlation between pentagonal planetary cycles and the stock market. Analysis of long-term cycles in any market should always start with Uranus.

### URANUS

The period of Uranus is a little more than 84 years, which is five times the 17-year cycle. When the complete  $360^\circ$  Uranus cycle is divided into 17-year sections the pentagram is formed with points separated by  $72^\circ$ . The

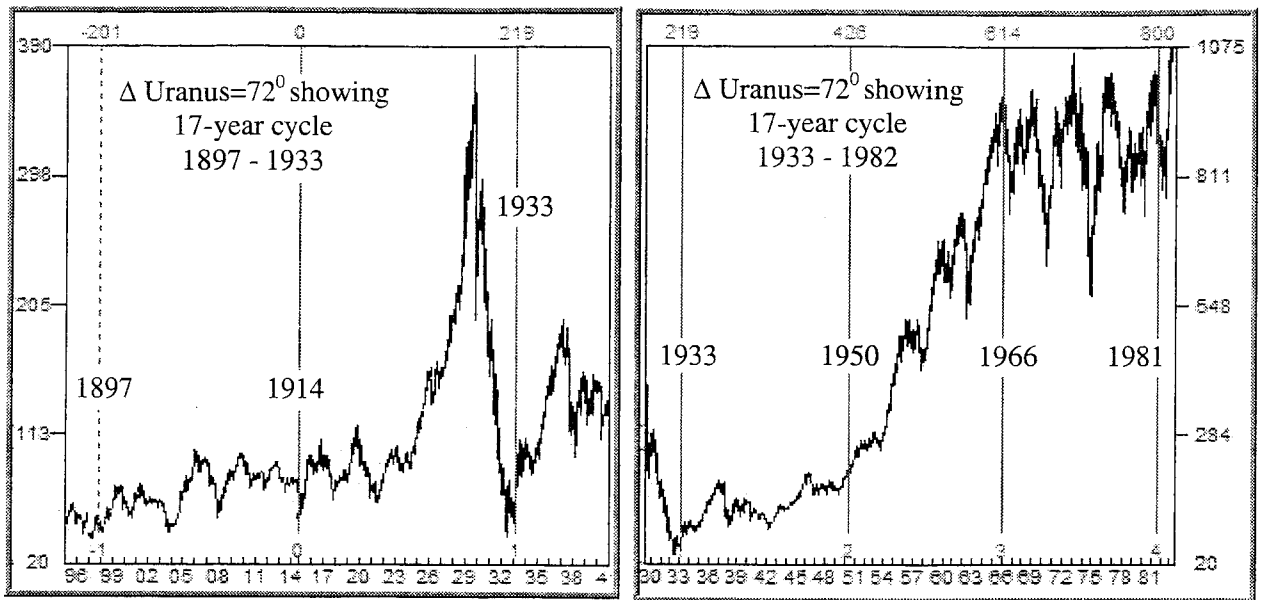
points of the Triple Triangle are separated by  $144^\circ$ , or 34 years. In other words, the Uranus Square of Twelve is 34 years.

Chart 3.1 plots the  $72^\circ$  Uranus cycle with monthly DJIA data and the bars compressed closely together to show several cycles. One complete 84-year Uranus cycle from 1897 to 1982 is shown spanning five complete 17-year cycles. The software does not allow any "fudging" of the data because all cycles are automatically calculated and drawn on the chart. The origin of the cycle is set to the reopening of the market in 12/12/1914 and the data is plotted using a non-logarithmic



**Figure 3.1**

Uranus moves  $72^\circ$  in 17 years.



**Chart 3.1**

$\Delta$  Uranus= $72^\circ$  cycle in monthly DJIA 1897-1982. Origin at the 12/12/1914 reopening.

price scale to emphasize the magnitude of the up moves during the 1914-1932 and 1949-1966 cycles. Each of the  $72^\circ$  Uranus cycles show a good correlation with significant market turns at 17-year intervals.

The reader should repeat this analysis himself either with software or by hand. It is a good learning experience to see first-hand how well these cycles align with major market turns. Only reading the results in a book does not provide the awareness needed to fully grasp what is happening.

Chart 3.2 provides a closer view of each of these 17-year periods by plotting them with weekly data. Chart 3.3 zooms in further to daily.

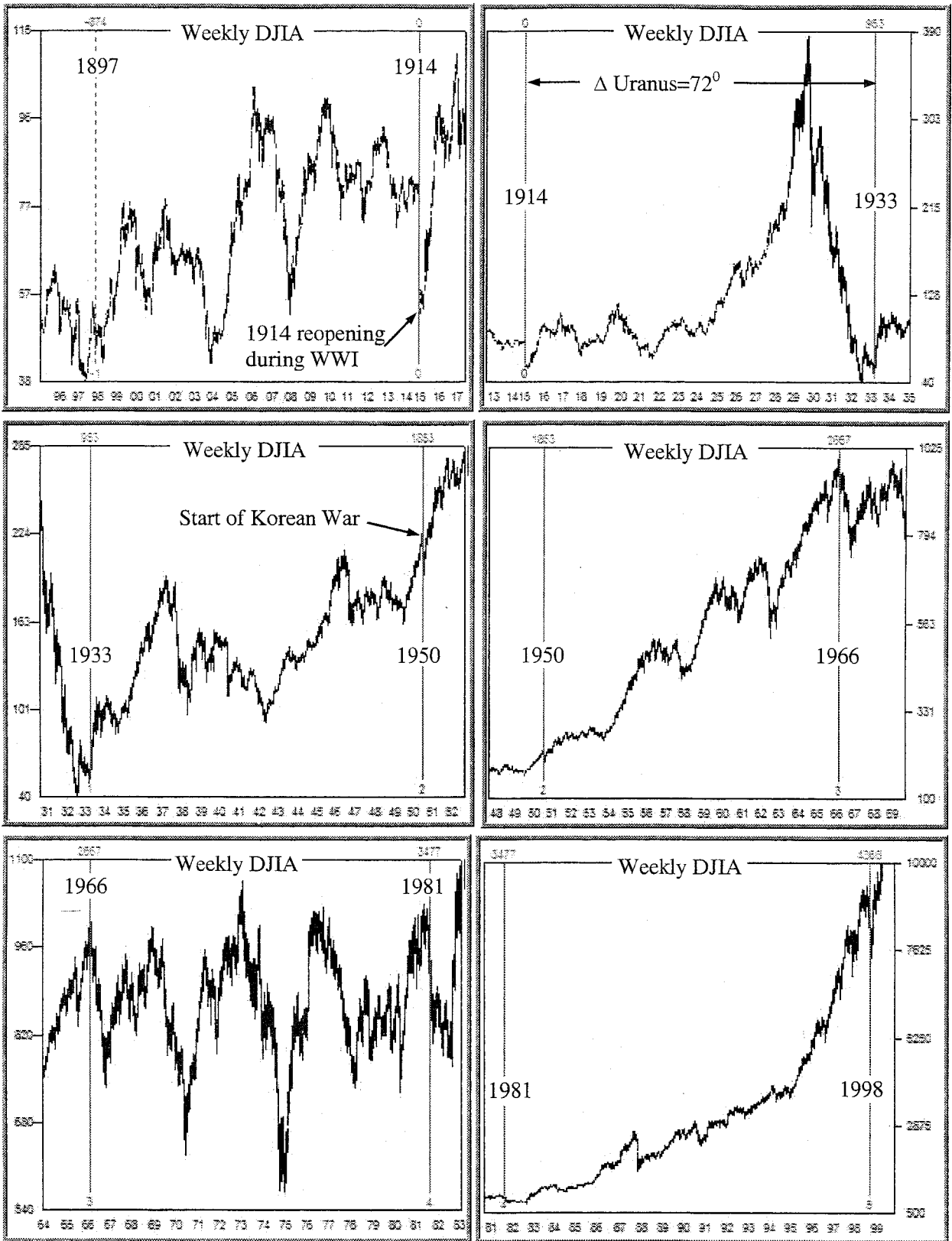
### THE URANUS TRIPLE TRIANGLE

Because Uranus is such a slow moving planet it helps to find its exact location at each of the 17-year cycle turns and measure how far it has moved from previous turns. Figure 3.2 plots these results in a  $360^\circ$  circle

using dates of DJIA market turns.<sup>9</sup> It can be seen that each turn was very close to  $72^\circ$  from the one preceding it. An even closer correlation exists between market turns and the Triple Triangle, or Square of Twelve,  $144^\circ$ . This represents two 17-year cycles and deviated less than one degree, a very close correlation.

The most deviation from the ideal value occurred in the 1981-1982 decline. That plunge occurred with the  $72^\circ$  axis arriving exactly in its middle when measured from 1914. The entire decline lasted 260 trading days from June to September 1981. The  $72^\circ$  axis occurred at day 130. This 1981-1982 decline will be further studied in the chapter *Mid-Cycle Panics*, where it will be shown that the 6/1981 top was  $180^\circ$  Uranus from the attack on Pearl Harbor.

<sup>9</sup> Zero degrees is the traditional zero Aries on the far left and increases as the cycle rotates counter clockwise.



**Chart 3.2**  
 $\Delta \text{Uranus}=72^\circ$  on weekly DJIA showing 17-year cycles. Origin is the 12/12/1914 reopening.

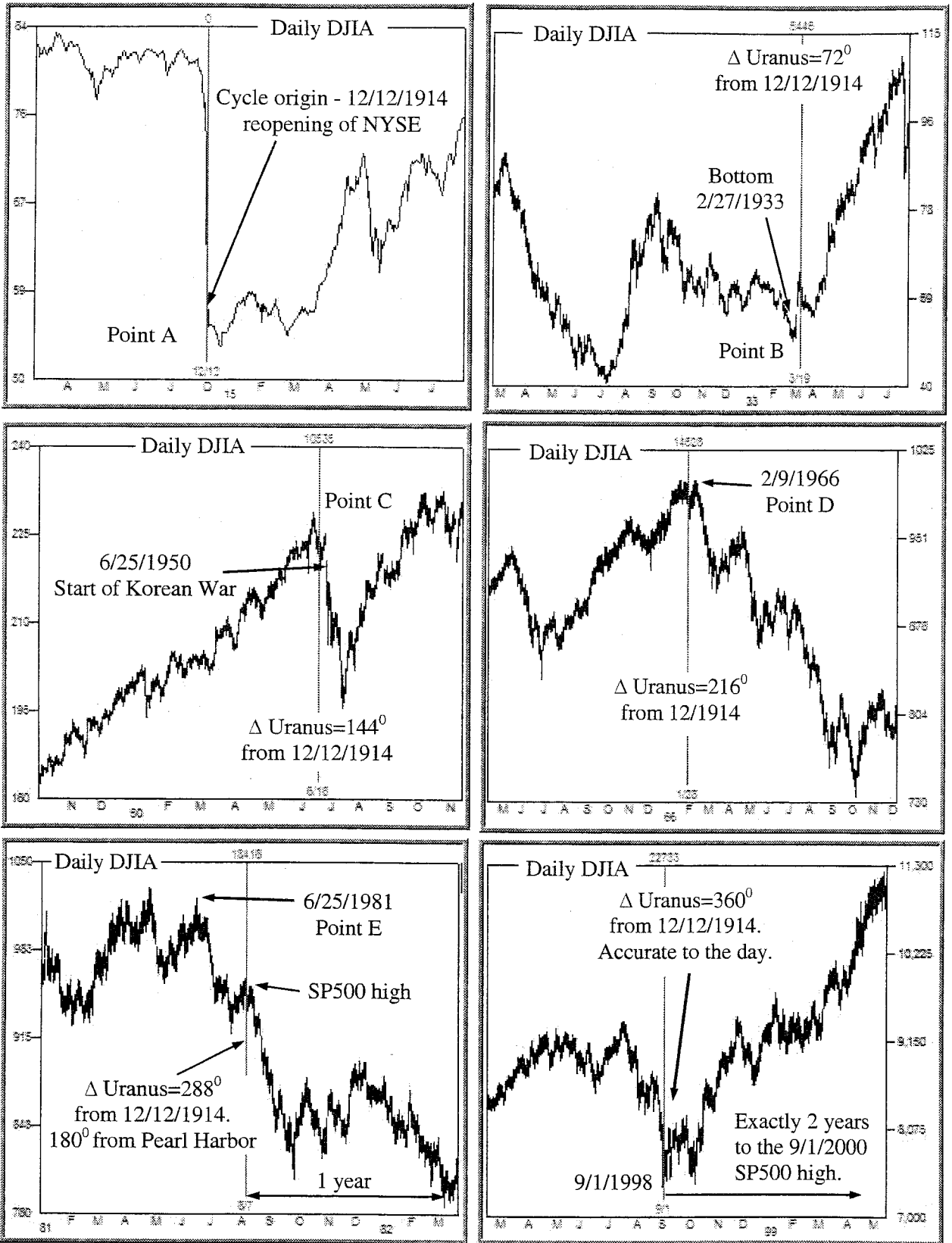
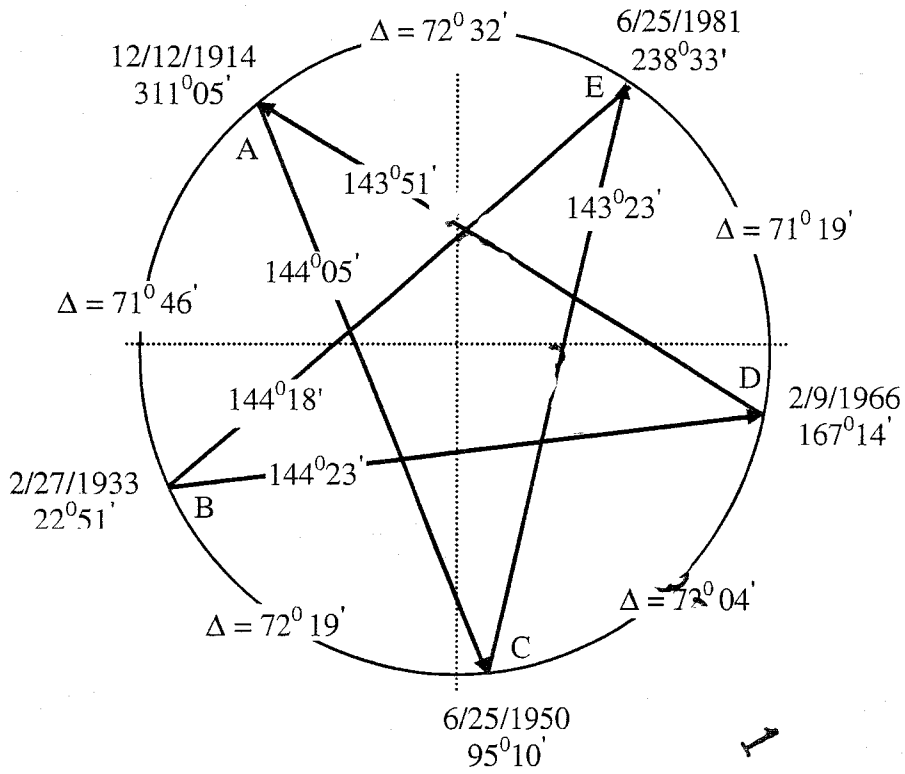


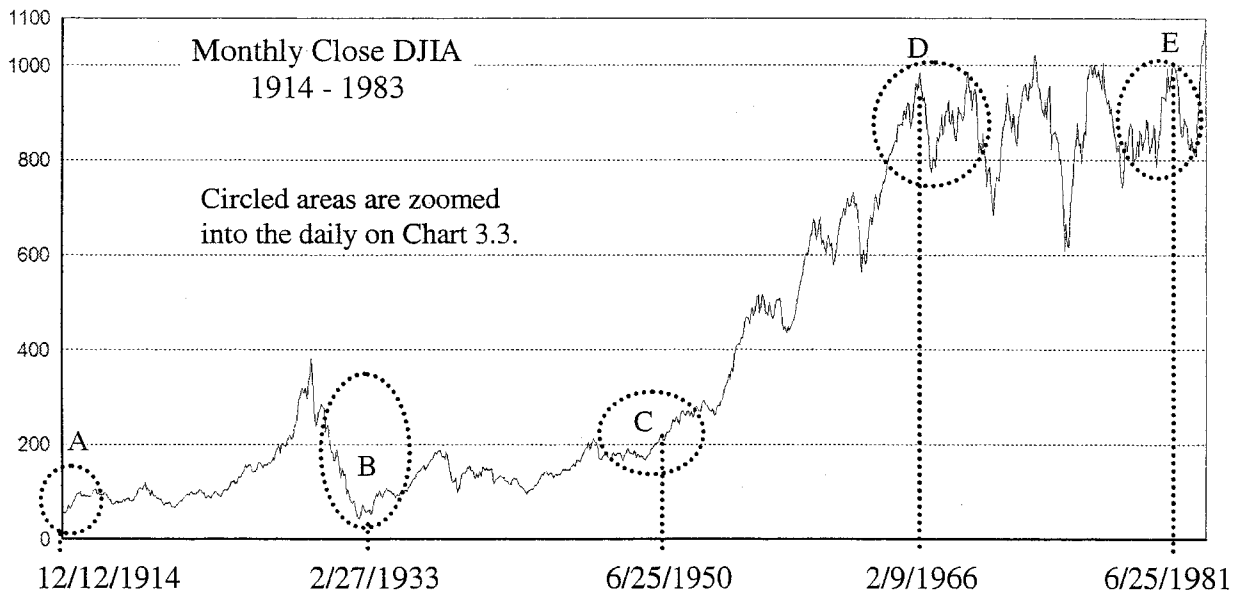
Chart 3.3

$\Delta \text{Uranus}=72^\circ$  on daily DJIA. Lettered points correspond with Figure 3.2.

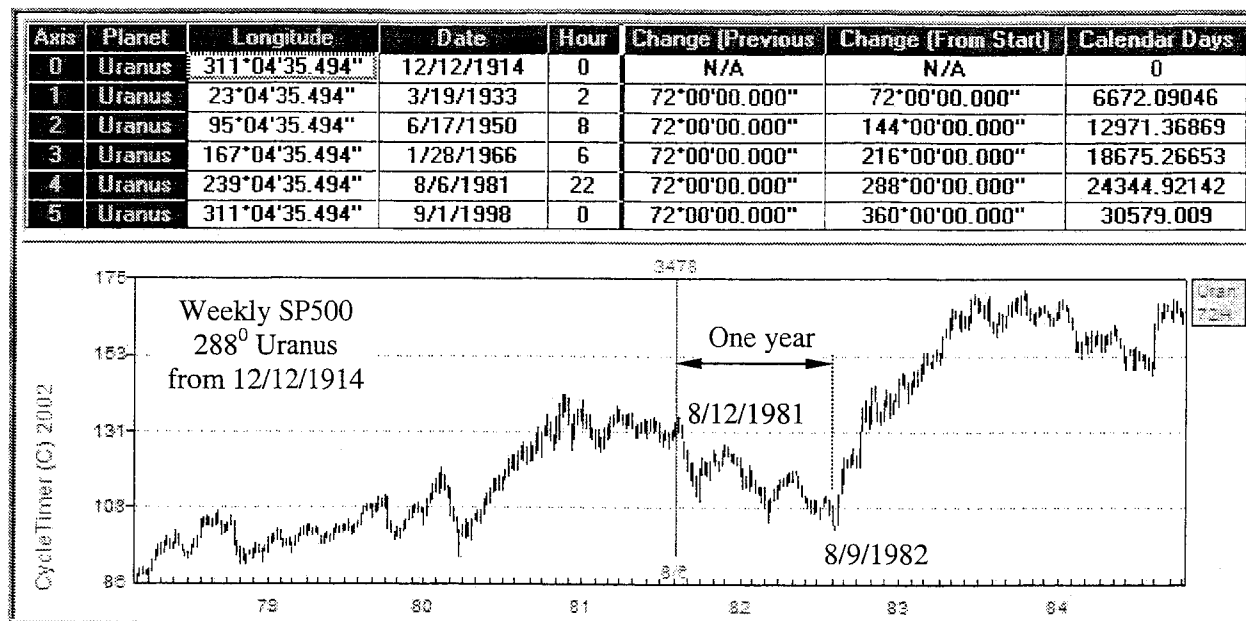




**Figure 3.2**  
 Uranus Triple Triangle and the Square of Twelve in DJIA.  
 Lettered pentagram points correspond with Charts 3.3 and 3.4.



**Chart 3.4**  
 17-Year stock market cycle with corresponding pentagonal points from Figure 3.2.



**Chart 3.5**

Fourth  $\Delta$  Uranus= $72^\circ$  cycle from 12/12/1914 in the SP500. Total displacement= $288^\circ$ .

The 1981 top provides a good example of the difficulty in using DJIA data. It is rarely the index of choice for more recent analysis. However, for long-term cycles the DJIA is the only choice.<sup>10</sup> Chart 3.5 shows that the fourth recurrence of the  $\Delta$  Uranus= $72^\circ$  axis ( $288^\circ$  total) arrived right on schedule in the SP500 on August 6<sup>th</sup>. One year later the market bottomed leading to the 17-year bull market of 1982-2000.

### **POSSIBLE ORIGIN OF THE URANUS PENTAGRAM**

What makes these five zodiac points so important? Why is the stock market aligned with these points in the  $360^\circ$  Uranus circle and not somewhere else? If there were no data prior to 1914 a compelling argument could be made that the cycles originated

with the reopening of the market in 1914. However, when we plot the Uranus cycle back in time prior to 1914 we find major turning points at the same zodiac locations.

Chart 3.2 shows that setting the cycle origin to the market reopening in 12/12/1914 and looking back  $72^\circ$  gives another major market bottom in 1897. What else happened in 1897 that might give a clue to the origin of this cycle? In April 1897 there was a major conjunction of Saturn and Uranus.<sup>11</sup> Mars and Jupiter also conjoined near this time, as did most of the other planets.

Chart 3.6 shows 108 years of the 17-year cycle originating at the 1792 Buttonwood Agreement. The cycles repeated reliably until they realigned in 1897 at the great

<sup>10</sup> Published data for the SP500 began in 1957. Although some data is available back to 1918 it is actually spliced together with the SP90.

<sup>11</sup> Table 7.1 lists all the Saturn-Uranus conjunctions for 700 years. The fifth entry in that table shows Saturn and Uranus conjoined in 4/1897, very close to the Uranus cycle bottom.

conjunction of all the planets. Prior to that date the cycle measured from 1792 arrived in 1891.

The great conjunction of 1897 and the importance of the five major zodiac points will be further studied throughout this book. The chapter *The Great Pentagram* will present the birth chart of the New York Stock Exchange providing additional insight into the origin of this pentagram.

Analysis prior to 1914 can be tricky because the index changed often. The stocks included in the index after 1914 showed little similarity to those used in 1913, or 1885. However, the general location of time cycles prior to 1914 can be found if price level comparisons are discarded and only time is studied.

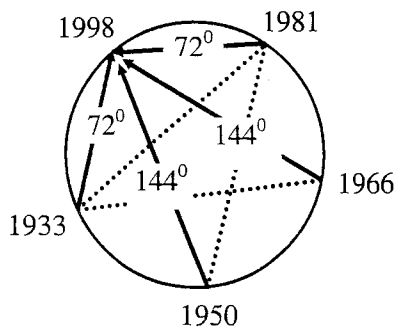
Further complicating the pre-1914 analysis is that the market was closed for 4½ months between 7/31/1914 - 12/12/1914, during which Uranus moved 1°29'.

Chart 3.7 compares the four 17-year cycles in the down phase since 1897. They are separated by about 34 years. The 144° movement of Uranus between sensitive points on each chart is identified. The circle to the right of each chart shows the displacement of Uranus during each 17-year cycle. The date on the opposite side of the zodiac from that motion is the apex of the Golden Triangle.

**TIME CYCLE TRIANGULATION**

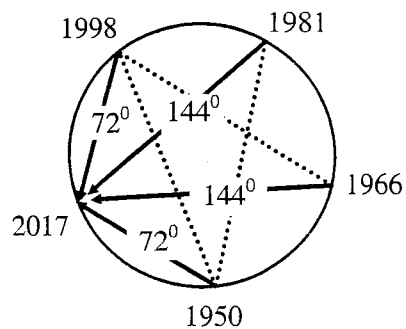
A key advantage to having time cycles drawn in a circle, as in Figure 3.2, is that it allows for time triangulation from multiple points on the circle. Since this particular cycle is pentagonal, each point can be triangulated with four additional points in time to locate its position. For example, Figure 3.3 shows the arrival date for the 1998 cycle can be triangulated with the data points from 1981, 1933, 1950, and 1966. Similarly, the 2017 cycle can be projected with the data points from 1998, 1981, 1966, and 1950.

1.  $1998 = 1981 + 72^{\circ}$
2.  $1998 = 1933 + 72^{\circ}$
3.  $1998 = 1950 + 144^{\circ}$
4.  $1998 = 1966 + 144^{\circ}$



**Figure 3.3**  
Triangulating the 1998 cycle with four pentagram points.

1.  $9/1/1998 + 72^{\circ} = 12/7/2016$
2.  $8/12/1981 \text{ (SP500)} + 144^{\circ} = 12/13/2016$
3.  $2/9/1966 + 144^{\circ} = 12/21/2016$
4.  $6/23/1950 + 72^{\circ} = 12/13/2016$



**Figure 3.4**  
Triangulating the 2017 cycle with four pentagram points.

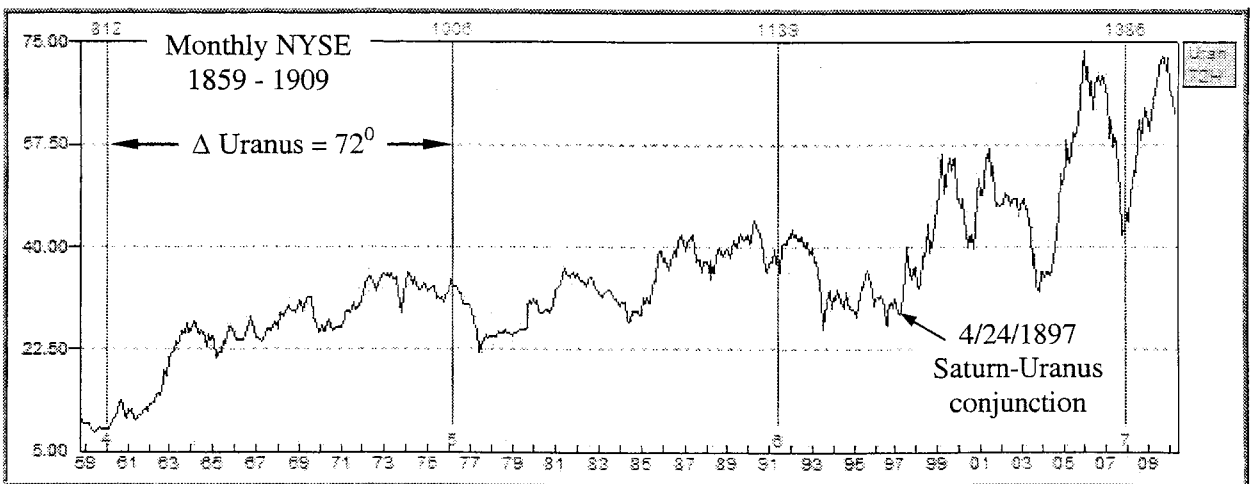
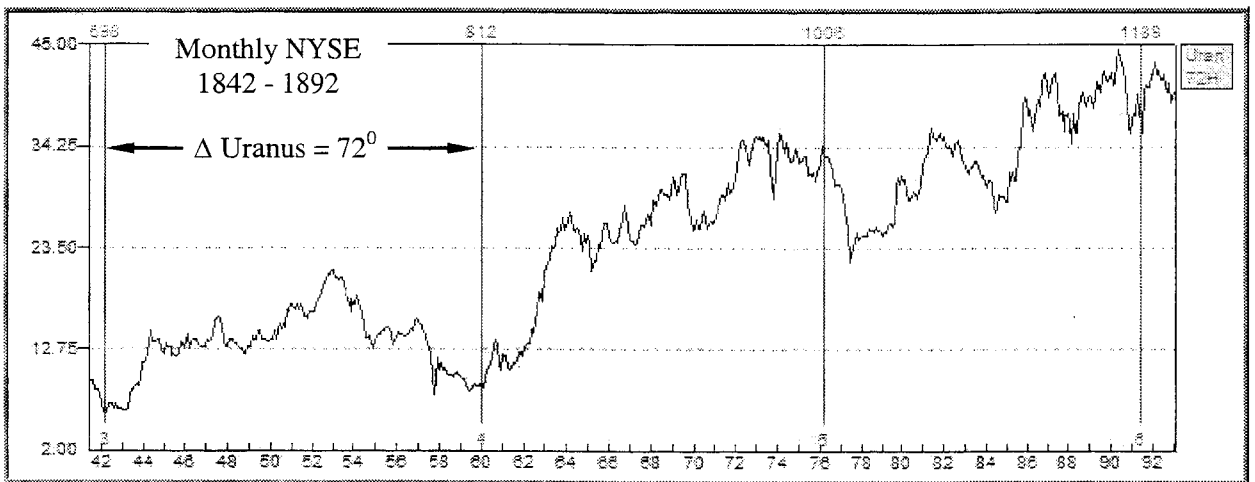
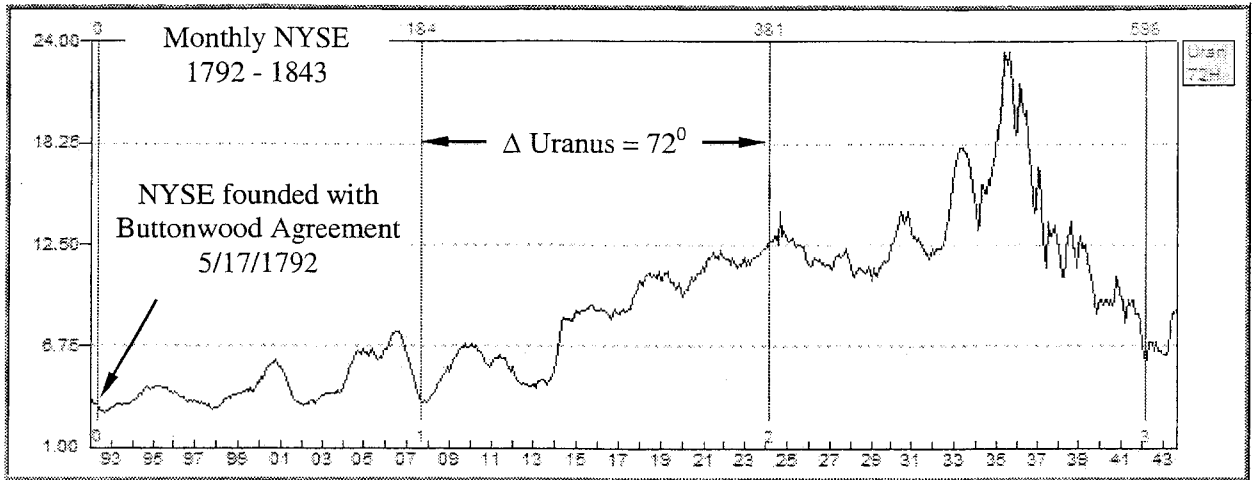
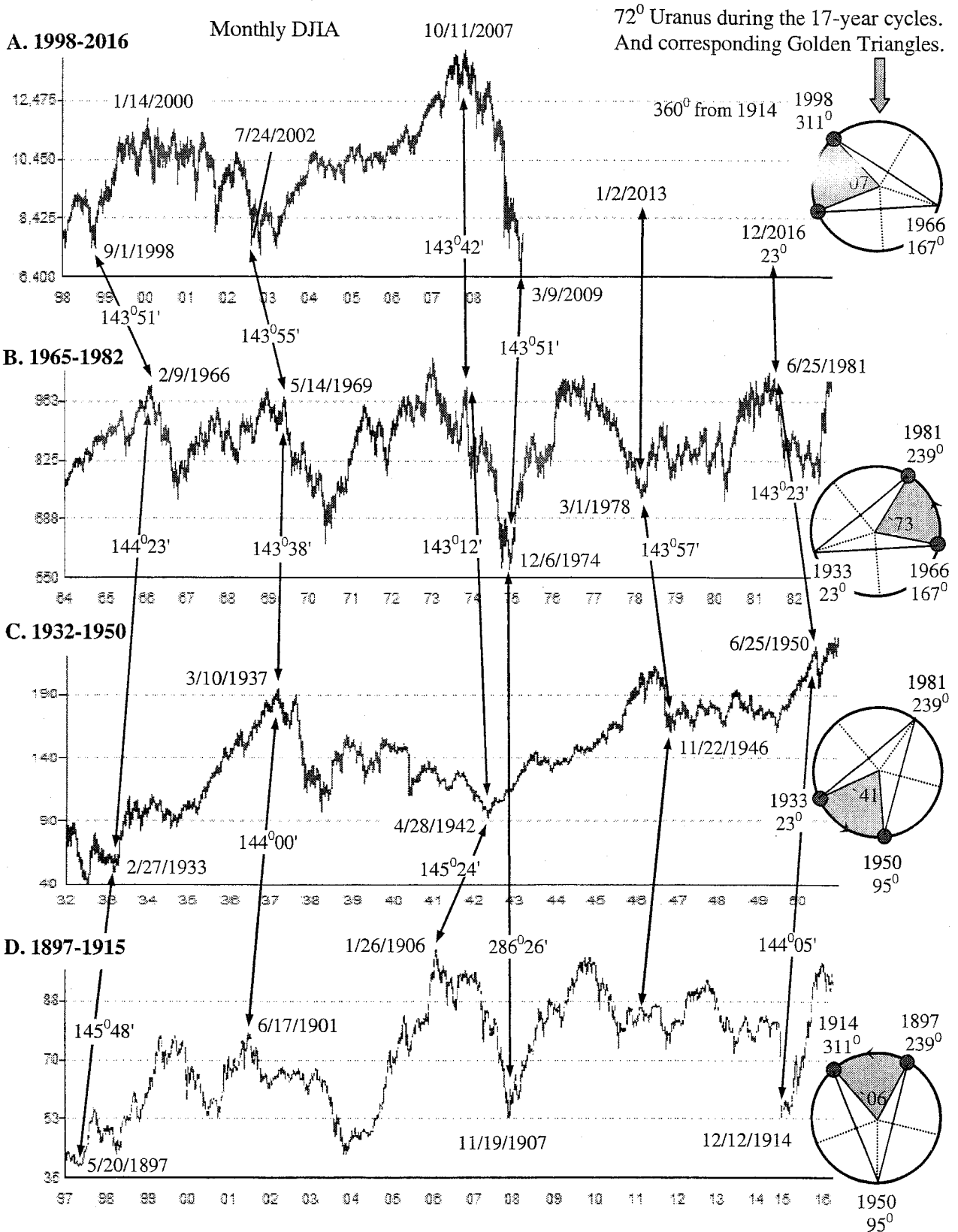


Chart 3.6

$\Delta \text{Uranus} = 72^\circ$  from the 5/17/1792 Buttonwood Agreement founding the NYSE to 1907.



**Chart 3.7**

$\Delta$  Uranus= $144^\circ$ , Square of Twelve, separates sensitive points in DJIA 34-year cycles.

# 4

## *Mid-Cycle Panics And The Law Of Alternation*

*"Nature alternates dynamically" ...Lao Tzu (Tao Te Ching)*

The previous section studied the correlation between the Uranus pentagram and the beginning and ending dates of the 17-year cycle. This chapter will study the price collapses that typically occur in the middle of the 17-year cycles. A new application of pentagonal cycle theory will be combined with the natural Law of Alternation to show how to forecast these dramatic panics.

For the past 200+ years the 17-year cycle has repeated with alternating advancing and declining trends.

<u>Down Trend</u>	<u>Up Trend</u>
1897 – 1914	1914 - 1932
1932 – 1949	1949 - 1966
1966 – 1983	1983 - 2000
2000 – 2017	2017 - 2034

All four of the 17-year down cycles listed above showed a price collapse in the middle followed by rapid recovery, the "Rich Man's Panic" of 1907, World War II in 1942, the 1973-74 collapse exacerbated by the Arab oil embargo, and 2007-2009 triggered by the real estate decline. Each trough was about nine years from the beginning of the 17-year cycle and in each case the market mood was gloomy, doomsday, with near end-of-the-world pessimism. However, the truth was that each of these midpoint troughs marked the best time in the 17-year cycle to buy stocks because the price advance that immediately followed was the largest in the entire cycle. Informed investors who understand the cycles and keep a cool head know that these are times of great opportunity. Later chapters will show how

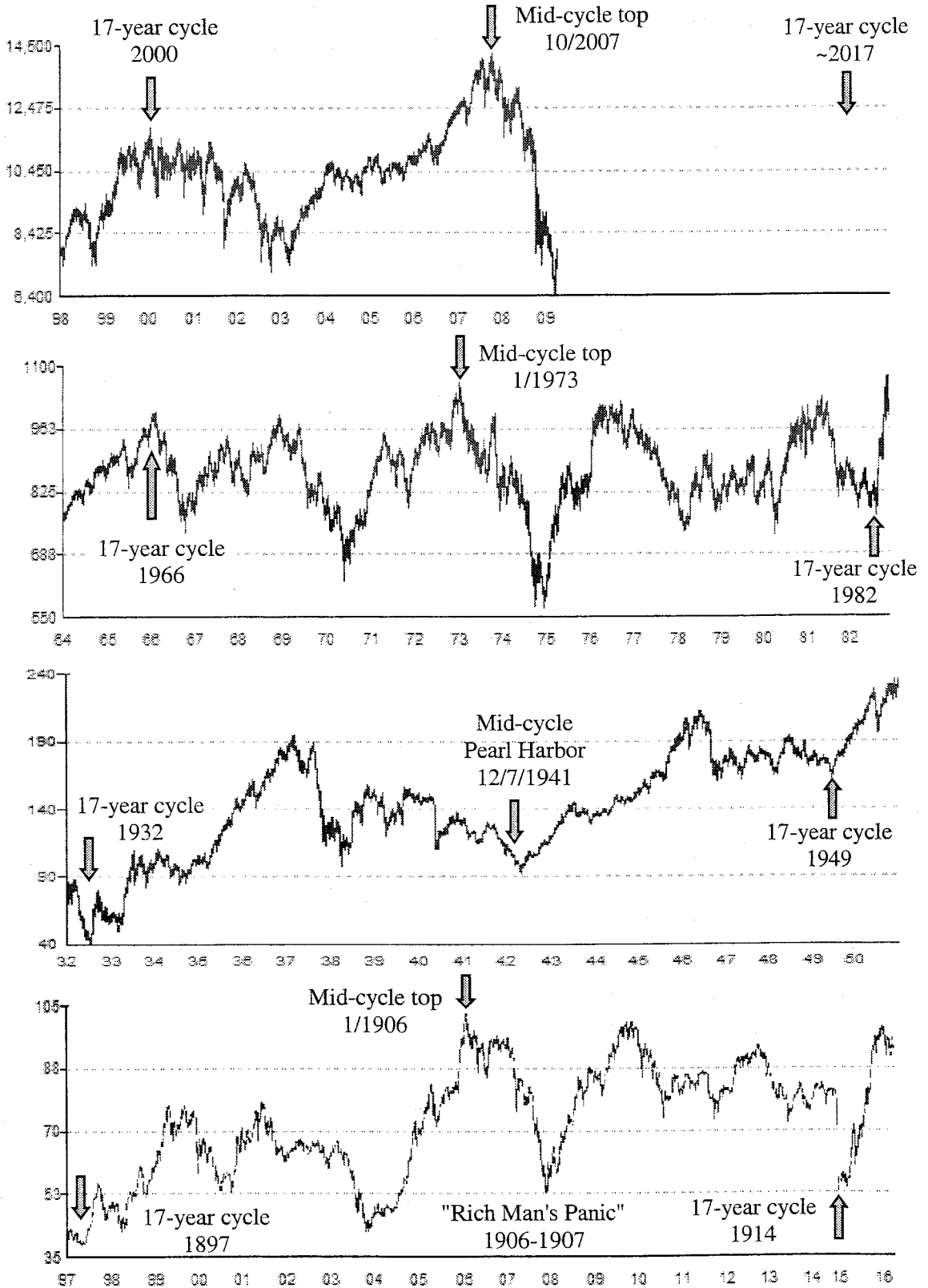
knowledge of this cycle helped this author make his first public forecast in several years advising investors to buy four trading hours before the March 6, 2009 bottom.

The caveat for buyers at mid-cycle troughs is that the price advance is followed by the decline at the end of the 17-year cycle typically lasting about three years. That means positions should be held a maximum of two years before moving back into cash and waiting for the end of the 17-year cycle. After the current cycle has expired, 2017 will again mark an excellent opportunity to buy-and-hold stocks for the long term.

Chart 4.1 shows the "Rich Man's Panic" of 1906-1907 was the largest decline of the 1897-1914 cycle. This panic started more than eight years into the 1897-1914 cycle, which is about half-way. The 96-week panic dropped prices 49% from the 1906 high of 103 to the 1907 low of 53.

The 1973-1975 plunge lasted 100 weeks and was the largest decline of the 1966-1982 cycle. Starting seven years into the 17-year cycle, this panic dropped intraday DJIA prices from 1067 to 570, or 47%. Both magnitude and duration were nearly identical to the Rich Man's Panic of 1906-1907.

More recently, the panic of 2007-2009 started seven years into the 2000-2017 cycle. This panic was a 55% decline from the 2007 intraday DJIA high of 14,280 to the March 2009 low of 6,440.



**Chart 4.1**  
Mid-cycle tops during 17-year cycle down phases.

Each of these declines occurred in 17-year cycles that were sideways and choppy. Separating these 17-year cycles were the up cycles of 1914-1929, 1949-1966, and 1982-2000.

### **MID-CYCLE PANICS AND ALTERNATING URANUS PENTAGRAMS**

The onset of mid-cycle panics do not occur randomly. They are very closely defined by their pentagonal relationship with Uranus and the 17-year cycle. Figure 4.1 shows the Uranus pentagram for one complete 84-year cycle beginning with the 1914 reopening. The dates on the outer circle are the previously studied 17-year cycles. A smaller inner pentagram connects the points of the inner pentagon. Because the inner pentagram is  $180^\circ$  out of phase with the outer pentagram, each point of the inner pentagram is mid-way between two points of the outer pentagram. For example, point J is halfway between points D and E on the outer pentagram and, more importantly,  $180^\circ$  from point B.

This  $180^\circ$  alternation of phase between the inner and outer Uranus pentagrams identifies their correlation with mid-cycle panics and allows for their timing. The expected arrival date of a mid-cycle panic is found by simply adding  $180^\circ$  to the location of Uranus at the start of a previous 17-year cycle. For example, Figure 4.1 shows that the panic starting in 1/11/1973 was  $180^\circ$  Uranus from the 17-year cycle bottom in 7/8/1932.

1. Add  $180^\circ$  Uranus to the beginning date of a down-trending 17-year cycle to find the mid-cycle top in the next down phase.

2. Add  $180^\circ$  Uranus to the start date of an up-trending 17-year cycle to find the mid-cycle bottom in the next up phase.

### **THE MID-CYCLE PANIC OF 1973-1974**

Mid-cycle declines are usually the most dramatic during down trending 17-year cycles and 1973 was no exception. Prices peaked intraday at 1,067 on 1/11/1973 and plunged 47% over the next two years until finally bottoming at 570.

The Law of Alternation matches the 1973 top with the end of the most dramatic panic in USA stock market history at the 1932 depression low. The 34-month decline that began in 1929 claimed a gut-wrenching 90% of the peak prices. 1932 also marked the 17-year cycle low when Uranus moved  $144^\circ$  from the 4/1897 conjunction.

Chart 4.2 plots 50 years of monthly DJIA data using compressed bars and a linear price scale. Usually charting 50 years of data requires a log price scale to see the price movements in earlier years. However, the drop after 1929 was so dramatic that a linear price scale works well enough for this analysis.

The cycle start date was set to the daily bottom on 7/8/1932. The  $\Delta$  Uranus= $180^\circ$  cycle is shown arriving 487 months later right at the 1973 top, the midpoint of the 1966-1982 17-year cycle. Between 1/1973 and 12/1974 the stock market's decline was the most dramatic since the 1929 crash.

The two charts on the bottom zoom into the cycle turns with daily charts to get a better view of how closely this  $180^\circ$  Uranus cycle matched the arrival of the 1973 top. The vertical lines are computer generated showing the cycle start and the date Uranus moved exactly  $180^\circ$ .

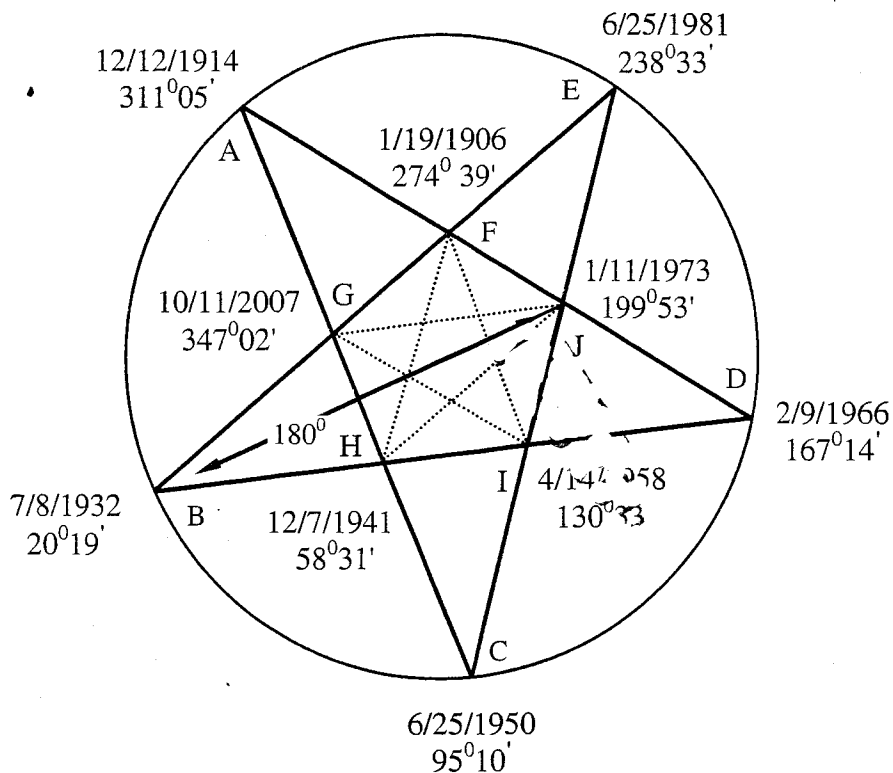


A picture is worth a thousand words and in this case the chart shows a very close correlation. The actual movement of Uranus between the 7/8/1932 low and the 1/11/1973 top was  $179^{\circ} 34'$ , very close to  $180^{\circ}$ .

If the origin of the cycle is set to the 3/1933 bottom the  $180^{\circ}$  point arrives at the secondary top in 10/1973, showing an inverted symmetry between these double bottoms and tops.

The pentagrams drawn on the chart provide a graphical view of the Law of Alternation at work connecting the inner and outer cycles. The outer pentagram on the chart shows Uranus was at  $20^{\circ} 19'$  at the 1932 bottom. The inner pentagram shows the 1973 top to be the point opposite the 1932 bottom.

Figure 4.1 shows that the 1932-1966-1981 recurrences of the 17-year cycle were three points on a Uranus Golden Triangle with 1932 at the apex. 1973 is the midpoint of the 1966-1981 base and the apex of a smaller Golden Triangle on the smaller inner pentagram,  $180^{\circ}$  out of phase from the larger triangle. The base of this smaller inner Golden Triangle included the 10/2007 mid-cycle top. Chart 3.7.B shows this arrangement with the small circle to the right of the chart.



**Figure 4.1**  
 One complete Uranus cycle. The outer pentagram identifies 17-year cycles. The inner pentagram identifies mid-cycle turns in the 17-year cycles. They are 180° Uranus from an outer pentagram point.

Outer Pentagram		Inner Pentagram		Δ Uranus
Date	Uranus Location	Date	Uranus Location	
A	12/12/1914	I	4/14/1958	179° 28'
B	7/8/1932	J	1/11/1973	179° 34'
C	6/25/1950 <sup>12</sup>	F	1/19/1906	180° 31'
D	2/9/1966	G	10/11/2007	179° 48'
E	6/25/1981	H	12/7/1941 <sup>13</sup>	180° 02'

**Table 4.1**  
 Mid-cycle turns are Δ Uranus=180° from the start of a previous 17-year cycle.

<sup>12</sup> 6/25/1950 marked the invasion of South Korea by the North starting the Korean War.

<sup>13</sup> 12/7/1941 marked the Japanese attack of Pearl Harbor bringing the USA into WWII.

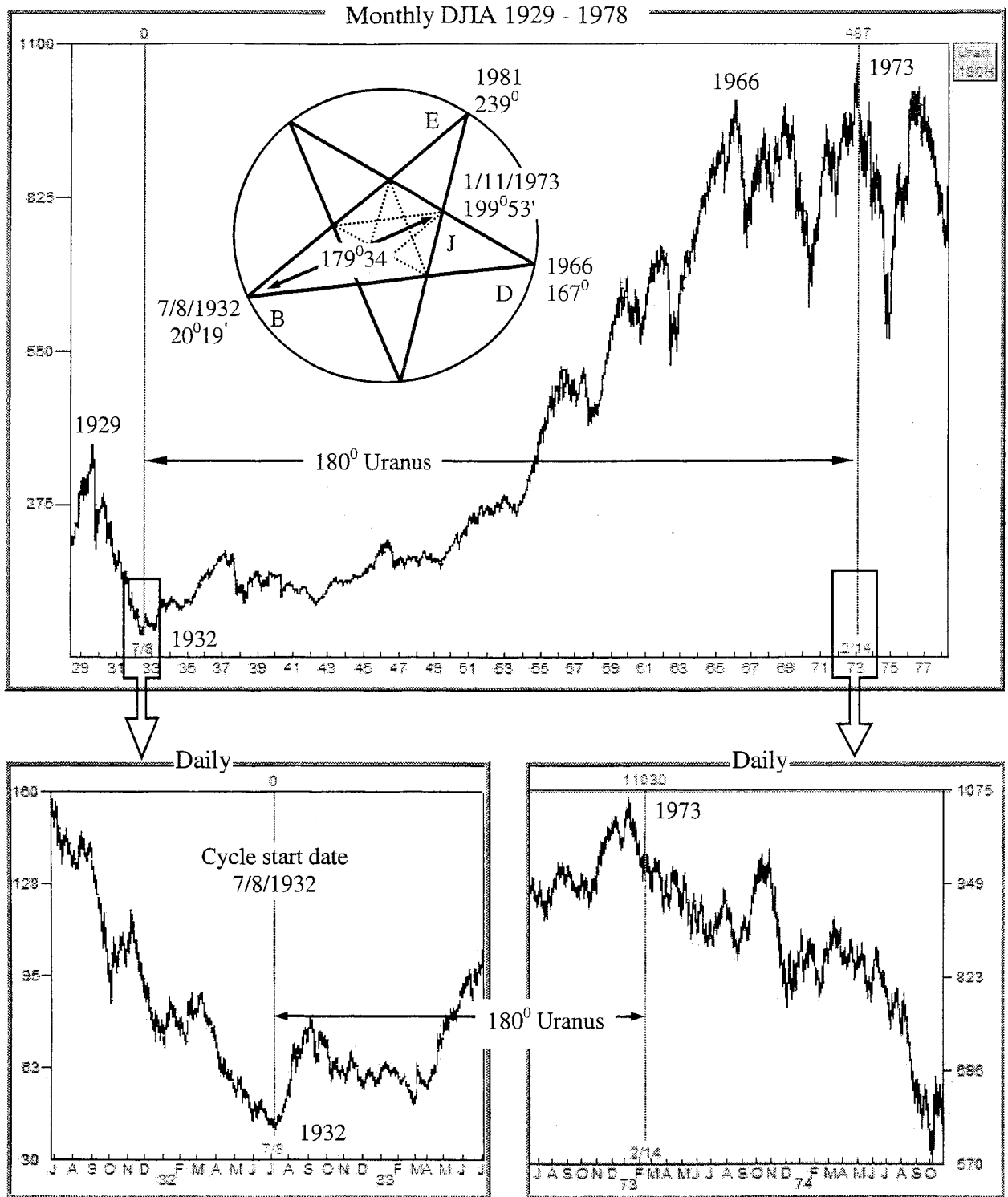


Chart 4.2

Mid-cycle panic of 1973-1974 and alternating pentagrams.

$\Delta$  Uranus=180° from the 7/8/1932 depression low to the 1/11/1973 top.

**THE MID-CYCLE PANIC OF 2007-2009**

The plunge in prices from the October 2007 top should not have caught anyone by surprise because it arrived right on schedule. Not only did it complete the 5-year cycle from the 2002 bottom, but it was also a nearly perfect pentagonal cycle point measured  $180^\circ$  Uranus from the start of the 1966-1982 17-year cycle.

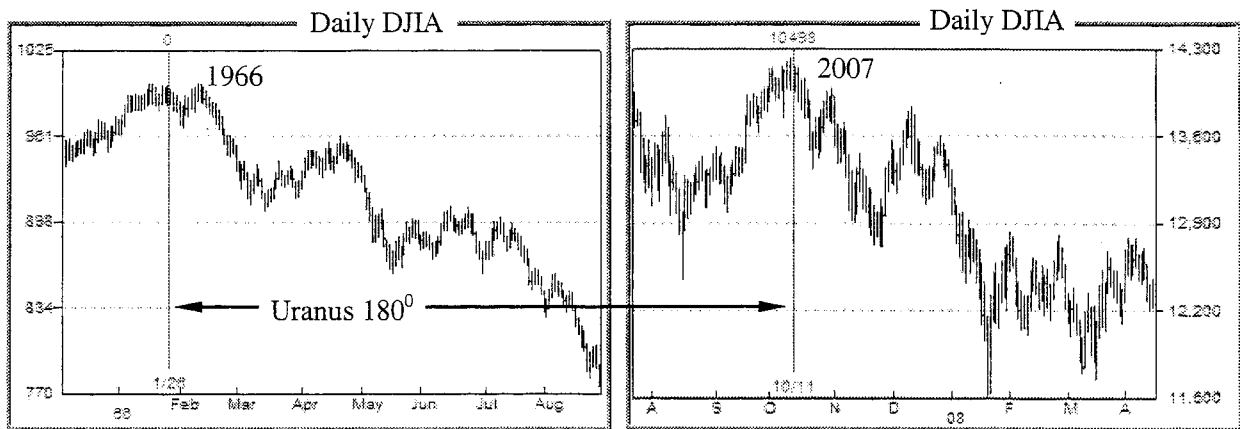
Chart 4.4 shows the monthly DJIA from 1961 to 2007 using a log price scale. The huge price increase during the 1982-2000 17-year cycle marked prices up in the DJIA from 770 to over 11,908 and on to 14,280 in 2007. A price difference like that requires a log price scale to see the smaller moves in 1966.

The  $\Delta$  Uranus= $180^\circ$  cycle is calculated beginning at the 2/9/1966 top. The resultant cycle arrived at the opposing pentagonal point in 10/28/2007. The actual price high was on 10/11/2007.

The corresponding pentagrams and  $\Delta$  Uranus  $180^\circ$  points are drawn on Chart 4.4. Notice that point A is 9/14/1998. Earlier diagrams of this pentagram showed this same point A as 12/12/1914. 1998 marked one complete Uranus cycle from the reopening in 12/12/1914, or five 17-year cycles of  $72^\circ$  each.

The daily charts at the bottom of Chart 4.4 zoom into the two tops to show that the market made a double top in 1966. The slightly higher top was on 2/9/1966 and was used as the cycle starting date. The actual movement of Uranus between 2/9/1966 and the top on 10/11/2007 was  $179^\circ 48'$ .

Chart 4.3 shows that if the first top in 1966 is used for the cycle start date the  $180^\circ$  cycle arrives exactly at the 10/11/2007 top, accurate to the day.



**Chart 4.3**

$\Delta$  Uranus= $180^\circ$  from the first top in 1/26/1966 to the 10/11/2007 top.

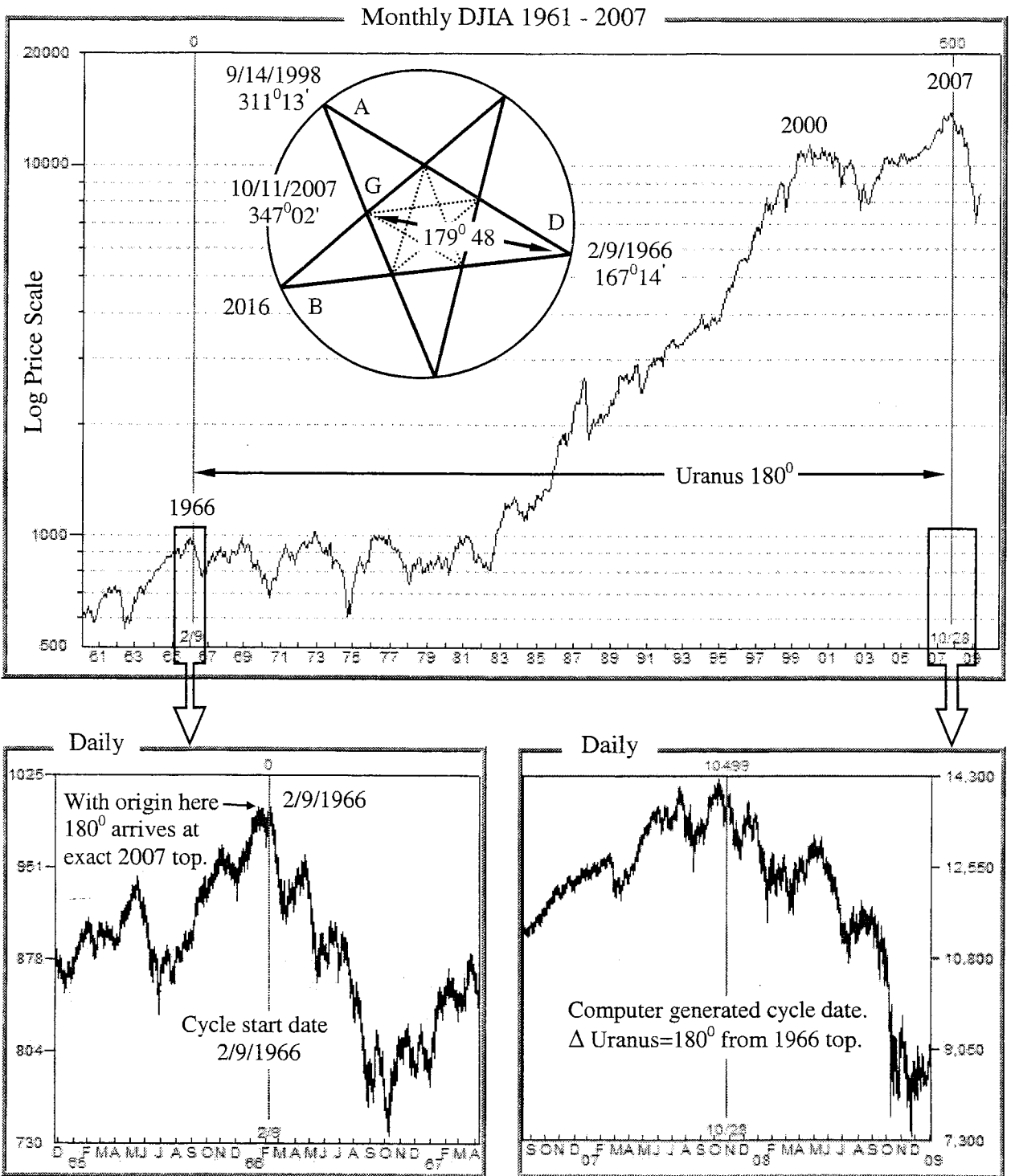


Chart 4.4

Mid-cycle panic of 2007-2009 and alternating pentagrams.  
 $\Delta$  Uranus=180° from the 1966 top to the 2007 top.

## PEARL HARBOR AND THE PANIC OF 1981

On December 7, 1941 at 7:40 a.m. the first of two waves of Japanese bombers came over the hills of Hawaii with the Pearl Harbor naval base in their sights. That attack launched the USA into the second great World War of the 20<sup>th</sup> century and stands as a milestone in American and world history.<sup>14</sup> The outcome of this war not only changed governments but also changed the entire power structure of governments worldwide for at least the next century. Had the fascist governments of Germany, Japan, and Italy won this war the world we live in now would be very different.

The American Civil War was similarly a milestone in world history. Had the south won that war and divided the USA into two separate countries it is quite possible the USA would have never entered the foreign wars in Europe and Asia resulting in a very different outcome.

If only a crazy man cherishes war, then markets must surely be insane. Markets and businesses have some of their most profitable times during wars. The Civil War saw a huge boom in stock market prices. The outbreak of World War II brought the USA out of a massive economic depression that had haunted it since 1929 and launched a stock market rally lasting until 1966.

In 1941 the stock market had been in a large compressing triangle since the secondary top

of April 1930. The bottom of this triangle contained the declines at least as far back as 1938 and possibly 1932. Two months before Pearl Harbor the market began a fast decline that touched the lower triangle in December 1941. When Pearl Harbor was attacked this support line broke down and prices plunged into the April 1942 Saturn-Uranus conjunction.

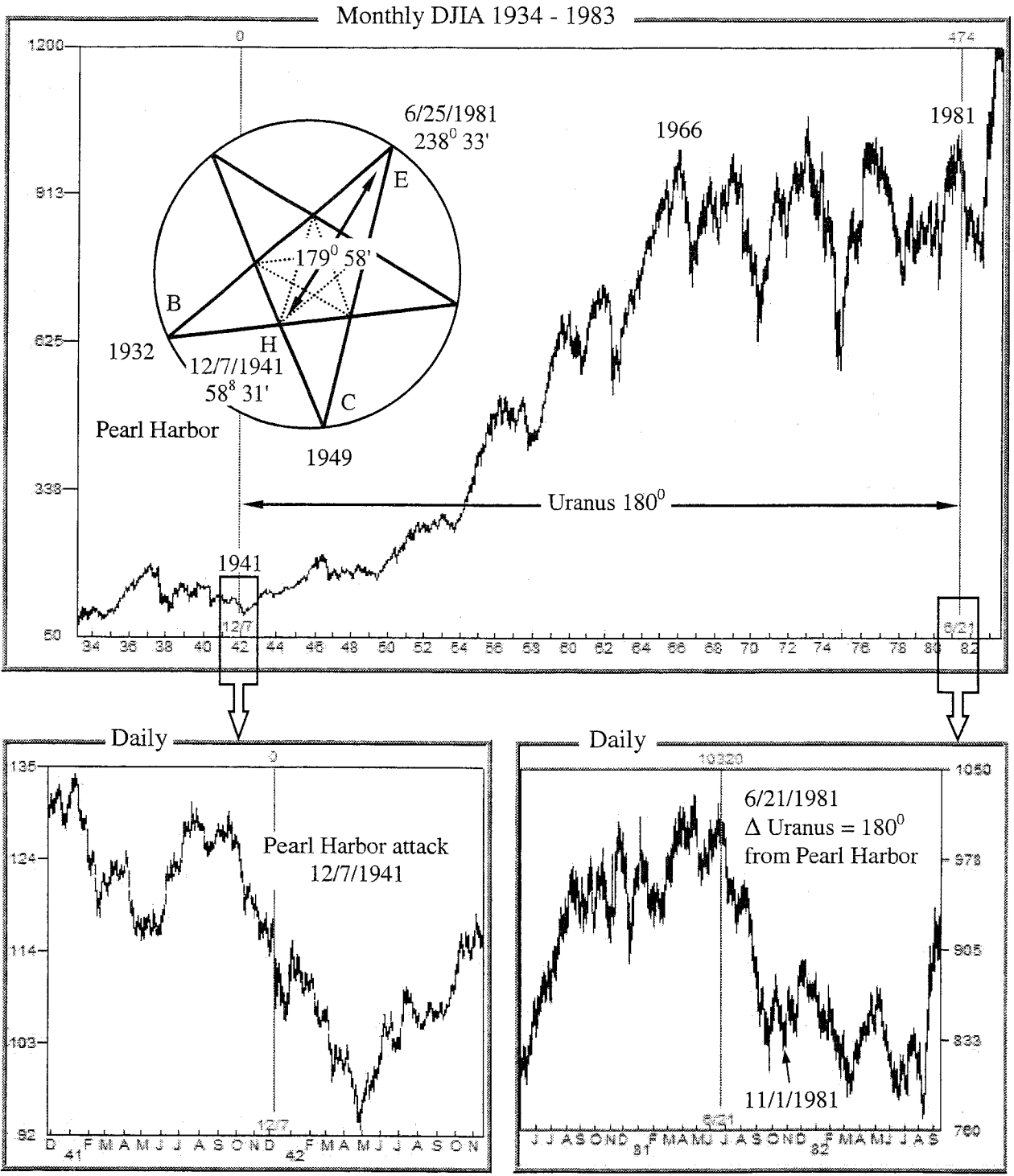
Chart 4.5 plots the  $\Delta$  Uranus= $180^{\circ}$  cycle originating with the attack on Pearl Harbor. The cycle arrival coincided exactly with the 1981-1982 panic. Prices topped on 6/15/1981 at 1,023 and plunged 21% in three months to the 9/28/1981 bottom at 807. The decline later continued ultimately bottoming at the 17-year cycle low in 8/9/1982 at 770, a 25% decline from 1981.

Chart 4.5 shows that the  $\Delta$  Uranus= $180^{\circ}$  cycle from Pearl Harbor arrived on 6/21/1981. The heavy selling in the DJIA began on 6/25/1981. If the cycle origin is set to the ultimate war low on 4/28/1942 the arrival date is the bottom on November 1, 1981. Again, the reader is encouraged to independently explore these cycles with his own analysis.

Looking back in time  $180^{\circ}$  Uranus from the attack on Pearl Harbor gives the 17-year cycle bottom in 1897, which also coincided with the Saturn-Uranus conjunction. The 1897-1982 period measured one complete Uranus cycle with the start of World War II in the middle. Saturn-Uranus conjunctions marked the 1897 start and 1942 middle of this 84-year Uranus cycle.<sup>15</sup>

<sup>14</sup> *Four-Dimensional Stock Market Structures And Cycles* showed the correlation between Uranus and the periodicity of American war. Uranus has completed two cycles since the signing of the Declaration of Independence on July 4, 1776. 1860 coincided with the Civil War. 1944 coincided with World War II. It returns in 2028.

<sup>15</sup> Later chapters will explore the harmony between Saturn and Uranus movements.



**Chart 4.5**

1981 mid-cycle panic, Pearl Harbor, and alternating pentagrams.  
 $\Delta$  Uranus=180° from Pearl Harbor to the panic of 1981.

### **THE KOREAN WAR AND THE 1906-1907 "RICH MAN'S PANIC"**

On June 25, 1950 North Korea with the full support of the communist governments of China and the Soviet Union crossed the 38<sup>th</sup> parallel and invaded South Korea in an attempt to reunify the two Koreas under communist rule. Only five years after the end of World War II, Americans were once again asked to send their young sons and husbands to fight and die for the freedom of those living in a foreign country.

China was soon drawn into this war and with traditional communist disregard for casualties General Peng slammed his men headfirst into the greatly outnumbered and mostly American positions. When night fell wave after wave of Chinese infantry assaulted NATO positions resulting in massive Chinese casualties. The total Chinese killed in this war is disputed and ranges from 100,000 to 1.5 million. The most common estimate is 400,000 dead. When the war ended 37,000 Americans and at least a million Chinese and Korean soldiers on both sides were dead. Another two+ million civilians were also dead. The result of the war was that both sides ended up right where they were before it started, at the 38<sup>th</sup> parallel.

Men quickly forget past mistakes and continue to walk down the same disastrous paths over and over again. Lessons learned and sacrifices made are soon forgotten. Yahoo recently published a survey of 18-25 year olds in South Korea. The survey asked which side they would support in a war between North Korea and the USA. These young Koreans answered North Korea. At great cost to the American taxpayer, 28,500 American soldiers are currently stationed in South Korea protecting the freedom and prosperity they enjoy.

This author has traveled many times throughout Asia and often talked with young people from many countries. Very few people under thirty even know about World War II. Most have no idea of the atrocities their people endured at the hands of the Japanese. Their schools do not teach about the war, especially in Japan. When the age is about thirty or older there is some knowledge of the war, mostly by word-of-mouth from their parents who endured it first hand.

Short memories are not limited to Asia. A 2008 survey of European adults showed they thought America was a greater threat to their freedom than is communist China. Three times in the 20<sup>th</sup> century the USA stood as the major factor securing European freedom, World War I, World War II, and the Cold War with the Soviet Union. European graveyards are filled with white crosses of American soldiers who fought and died for the freedom they have enjoyed for most of their lives.

Many countries around the world enjoy their prosperity under the security umbrella of the American military. They spend little or nothing on their own defense with no real worry of any external military threat. Table 4.2 shows the USA spent 41.5% of the world's total military expenditure in 2008.<sup>16</sup> That does not include the \$170 billion spent on the wars in Iraq and Afghanistan, and many "Black Box" items not reported. When those items are included the total is closer to 50% of the total world expenditure. Yet these facts are quickly forgotten because it is the nature of men to forget the things that keep them secure unless there is an immediate threat.

<sup>16</sup> Reference, Stockholm International Peace Research Institute. [www.sipri.org](http://www.sipri.org)



Country	2008 Defense Spending Apprx. Billions \$	2008 Spending Apprx. % GDP <sup>17</sup>	2008 Spending Apprx. Per Person
USA	607 + (170 for Iraq)	4.06	\$1,950 <sup>18</sup>
UK	65.3	2.4	\$1,100
France	65.7	2.3	\$1,100
Germany	46.8	1.3	\$568
Japan	46.3	0.9	\$361
Netherlands	12.2	1.6	\$750
Canada	19.3	1.2	\$581

**Table 4.2**

2008 military expenditures of various countries.

When the Korean War broke out on June 25, 1950 the market had been trending upward for several months. On the day of the invasion prices broke down quickly. The pattern was similar to the attack on Pearl Harbor where prices turned lower days earlier. Prices quickly collapsed into a bottom just a few days later. Then as with most wars the stock market began another boom. Outbreaks of wars typically cause a quick knee-jerk panic reaction down then a protracted uptrend as business gears up for increased war production.

Chart 4.6 shows that the Korean invasion was 180° Uranus from the January 1906 top leading to the "Rich Man's Panic of 1907".

### CONCLUSION

Every down trending 17-year cycle for the last 100 years had a mid-cycle panic corresponding with  $\Delta$  Uranus=180° from the start of a previous 17-year cycle. Four examples in both peace and war times have been shown.

#### Mid-cycle panics since 1906

1. 1906-1907  $\Delta$  Uranus=180° to the Korean War in 6/1950.
2. 1981-1982  $\Delta$  Uranus=180° from Pearl Harbor in 12/1941.
3. 1973-1974  $\Delta$  Uranus=180° from the 7/1932 bottom.
4. 2007-2009  $\Delta$  Uranus=180° from the 2/1966 top.

<sup>17</sup> Reference, Military expenditure: SIPRI Yearbook 2008: Armaments, Disarmament and International Security (Oxford University Press: Oxford, 2008), Appendix 5A.

<sup>18</sup> This does not include American spending on the Iraq and Afghanistan wars. Reference, CIA World Factbook. [www.cia.gov/library/publications/the-world-factbook/rankorder/2034rank.html](http://www.cia.gov/library/publications/the-world-factbook/rankorder/2034rank.html)

Monthly DJIA 1903 - 1953

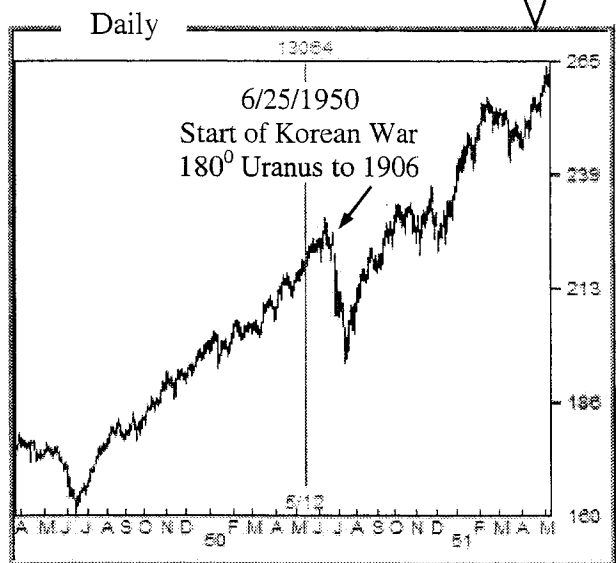
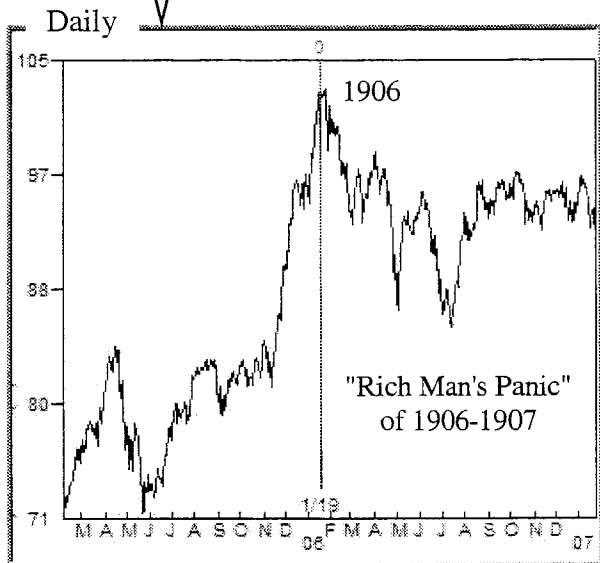
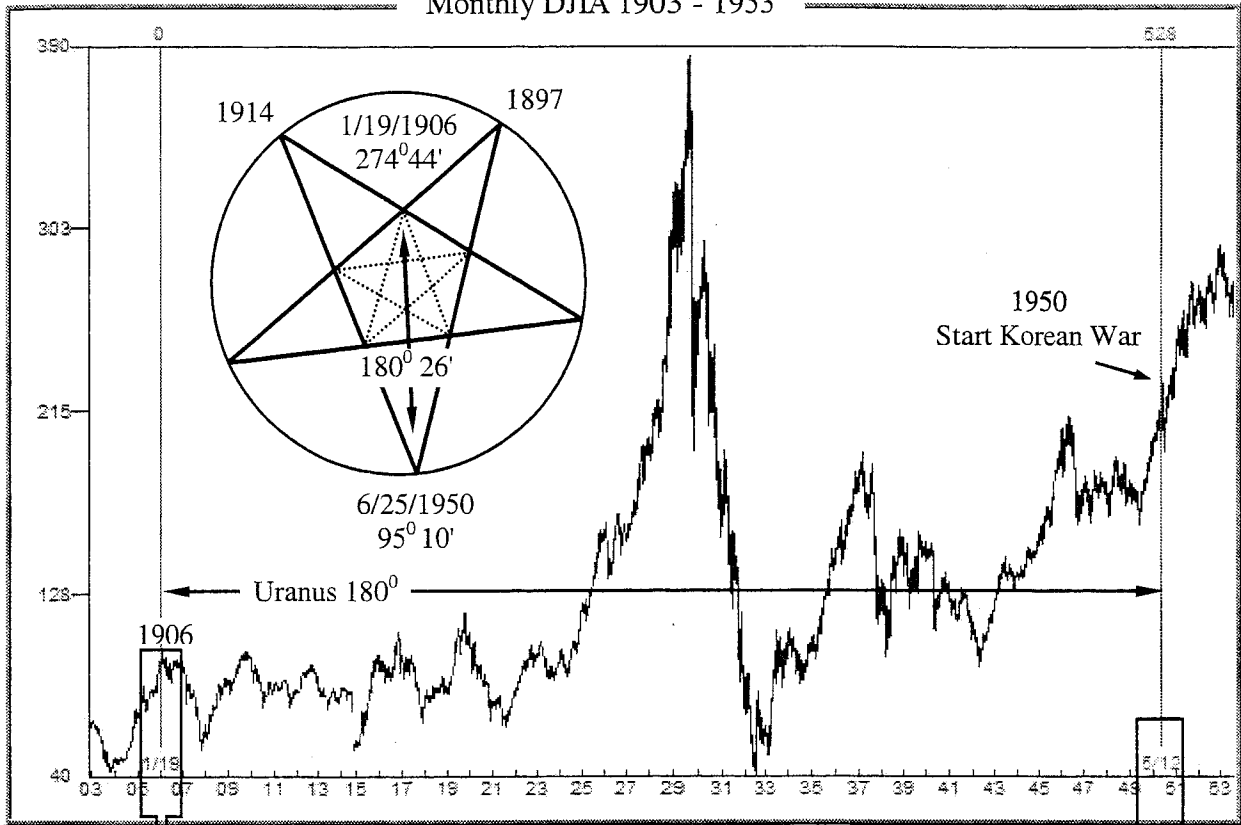


Chart 4.6

Rich Man's 1906 mid-cycle panic, the Korean War, and alternating pentagrams.  
 $\Delta$  Uranus= $180^{\circ}$  from the 1906-1907 "Rich Man's Panic" to the Korean War.

The previous chapter showed that mid-cycle panics of down trending 17-year cycles are accurately timed by the alternating pentagonal Uranus cycle. 17-year cycles in the up phase also have mid-cycle points corresponding with major acceleration bottoms. As with mid-cycle tops, the Law of Alternating Pentagrams and  $180^{\circ}$  Uranus from the start of a previous cycle times these bottoms. This chapter will study three examples, the 1924 bottom during the 1914-1932 cycle, the 1958 bottom during the 1949-1966 cycle, and the two bottoms in 1988 and 1994.

### ***THE 1924 ACCELERATION BOTTOM***

The 1924 bottom had special significance because it was the start of the 5-year cycle culminating in the "Crash of 1929".<sup>19</sup> This date will be later shown to mark the beginning of pattern matching with its 5-year cycle counterpart in November 1994.

Accurately applying daily cycle analysis prior to 2/16/1885 is difficult because NYSE daily data was not recorded prior to that date. Chart 5.2 applies another method by looking back in time  $180^{\circ}$  from the start of the 1966-1982 cycle to locate the 1924 bottom. Since it has already been shown that the 2007 top was  $180^{\circ}$  Uranus from 2/9/1966, the 1924 mid-cycle bottom was

---

<sup>19</sup> WD Gann mentions the 1924 bottom in various places in his Master Courses. One example is his 1935 *Forecasting* course, "1924 - May - The last low was made, from which a fast advance started one of the greatest bull campaigns in history, ending in 1929."

one complete Uranus cycle from the 2007 mid-cycle top.

### ***THE 1958 ACCELERATION BOTTOM***

The 1949-1966 cycle marched upward in a nearly vertical advance with only three interruptions in 1953, 1957, and 1962.<sup>20</sup> The 1957-58 bottom was flat because Saturn-Uranus turned up in 1957 and, as Chart 5.3 shows, the mid-cycle Uranus= $180^{\circ}$  turned up in 1958. One complete  $360^{\circ}$  cycle from 12/1914 was the 9/1998 bottom.

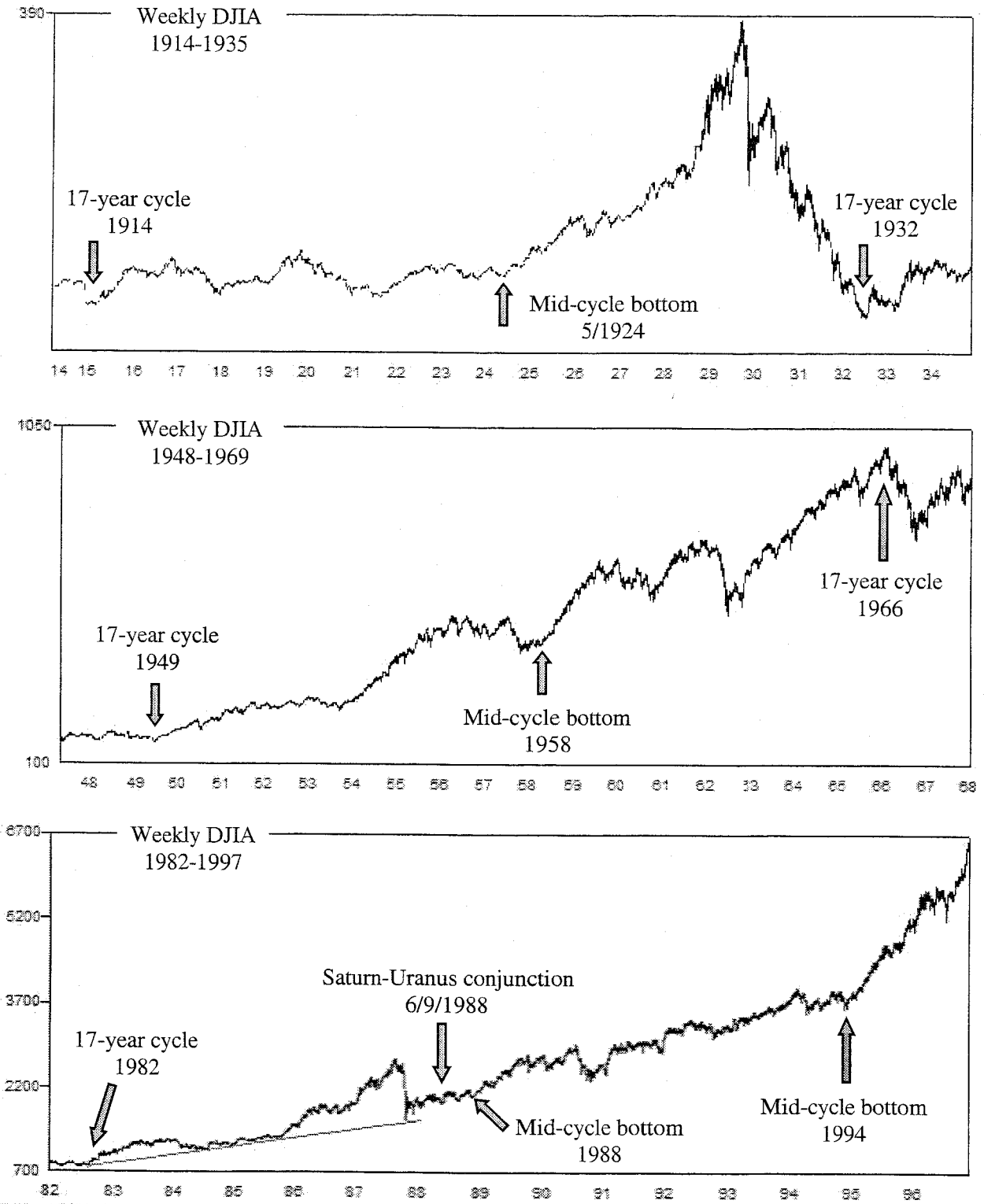
### ***THE 1988 AND 1994 ACCELERATION BOTTOMS***

In the three weeks between October 2-20, 1987 the stock market crashed intraday from 2662 to 1616. The true low is not actually known because only five of the thirty stocks were open at the recorded bottom. The other 25 had trading suspended because the huge sell order imbalance would have crashed prices even further. 1987 completed the 5-year cycle from 1982, just as 1929 completed the 5-year cycle from 1924.

Chart 5.4 shows that prices made a series of higher bottoms until November 16, 1988 when the final bottom was reached and prices skyrocketed higher. This cycle bottom was  $\Delta$  Uranus= $180^{\circ}$  from the start of the 1949-1966 17-year cycle and shortly after the Saturn-Uranus conjunction in June 1988.

---

<sup>20</sup> Appendix K shows these bottoms are closely timed by the Saturn-Uranus  $30^{\circ}$  cycle.



**Chart 5.1**

Mid-cycle acceleration bottoms in the three up trending 17-year cycles since 1914.

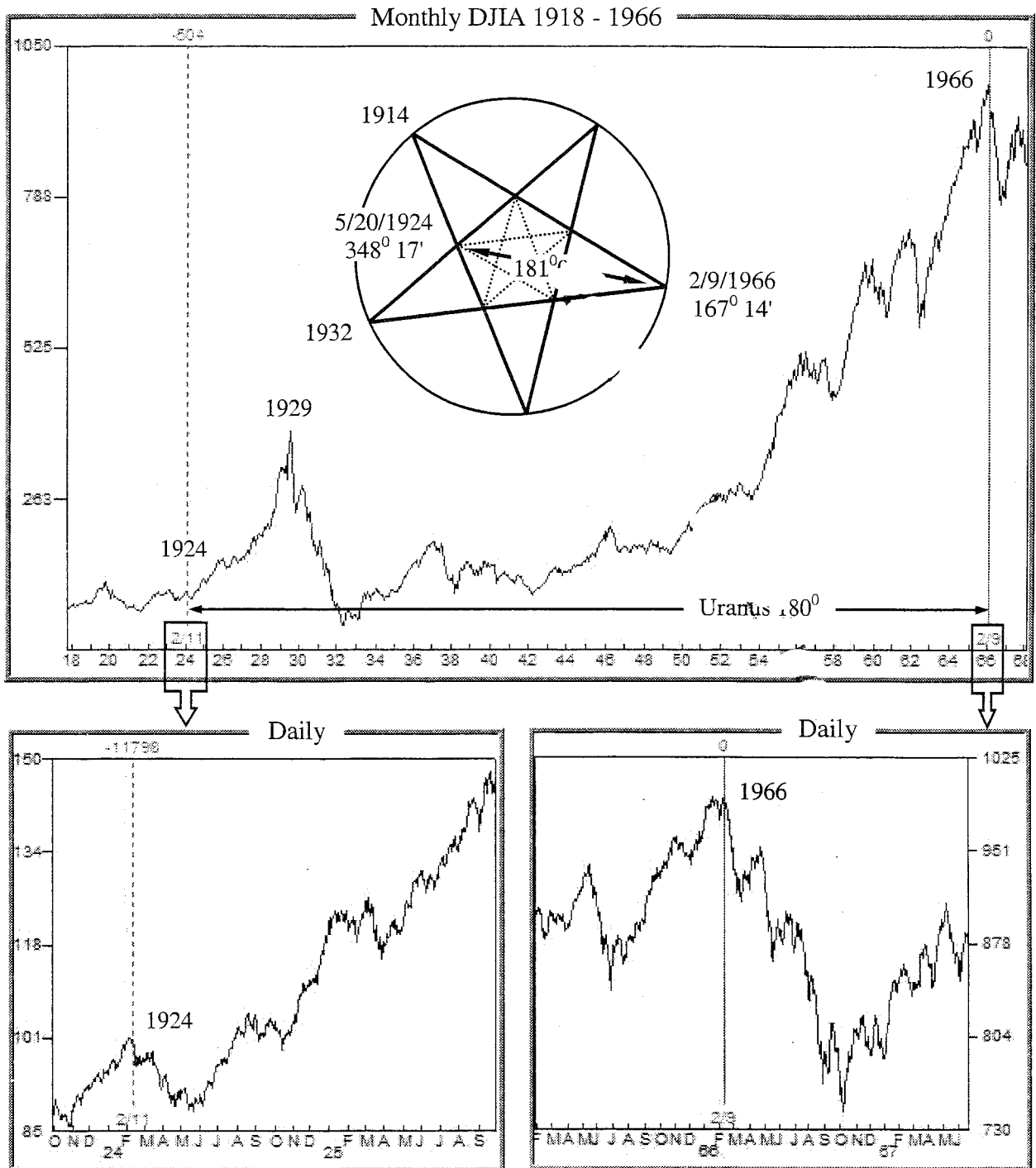


Chart 5.2

Pentagram mid-cycle bottom in 1924 and alternating pentagrams.  
 $\Delta$  Uranus= $180^\circ$  from the 1966 top to the 1924 bottom.

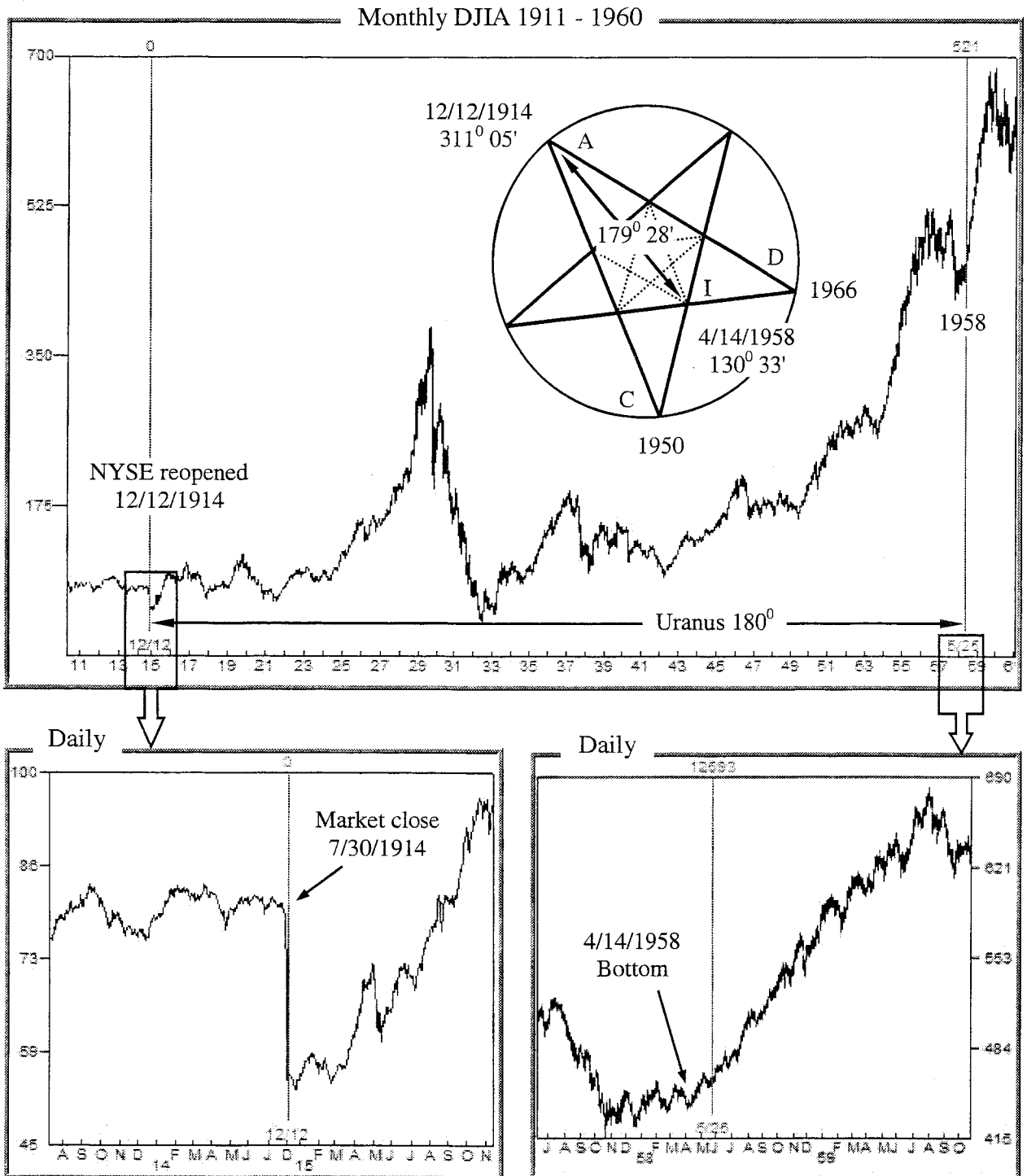


Chart 5.3

Pentagonal mid-cycle bottom in 1958 and alternating pentagrams.

$\Delta$  Uranus=180° from the 1914 NYSE reopening to the 1958 bottom.

The 1988  $\Delta$  Uranus= $180^\circ$  cycle arrived  $6\frac{1}{4}$  years from the 1982 start of the 17-year cycle. This was closer to the start than previous cycles and divided the 1982-2000 cycle into six and eleven years. The 11-year

section was further subdivided into six and five years with another acceleration bottom in November 1994, the beginning of the 5-year cycle to the top of the 17-year cycle in 2000.

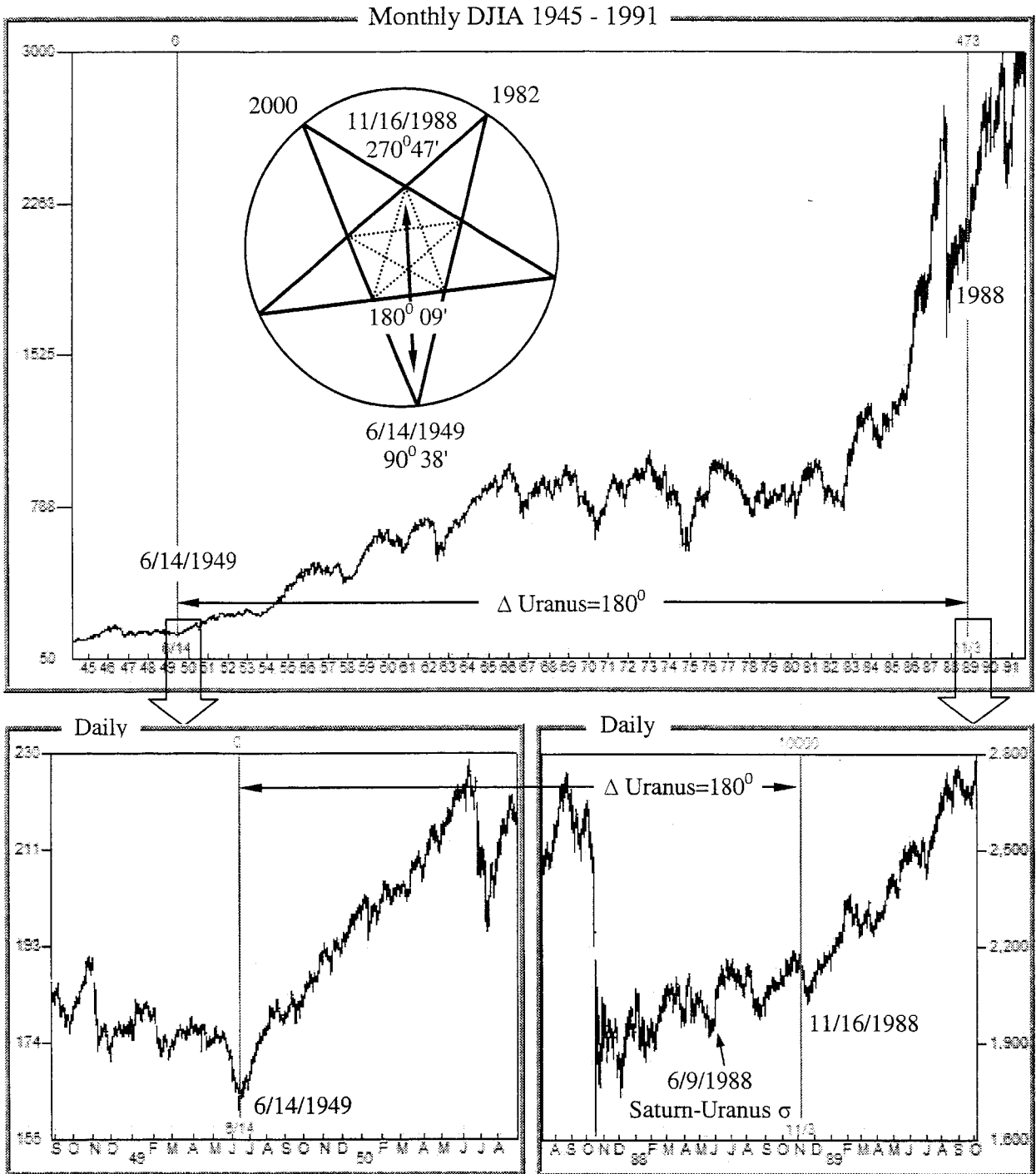


Chart 5.4

Pentagonal mid-cycle bottom in 1988 and alternating pentagrams.  
 $\Delta$  Uranus= $180^\circ$  from the 6/14/1949 bottom to the 1988 bottom.

# 6

## Uranus 18° Harmonics In The DJIA 1897 - 2007

Table 6.1 lists the 18° cycles for two complete Uranus cycles totaling 168 years from the 12/12/1914 reopening to 2082. 18° is the 5<sup>th</sup> harmonic of 90° (18 x 5 = 90) and the 4<sup>th</sup> harmonic of 72° (18 x 4 = 72).

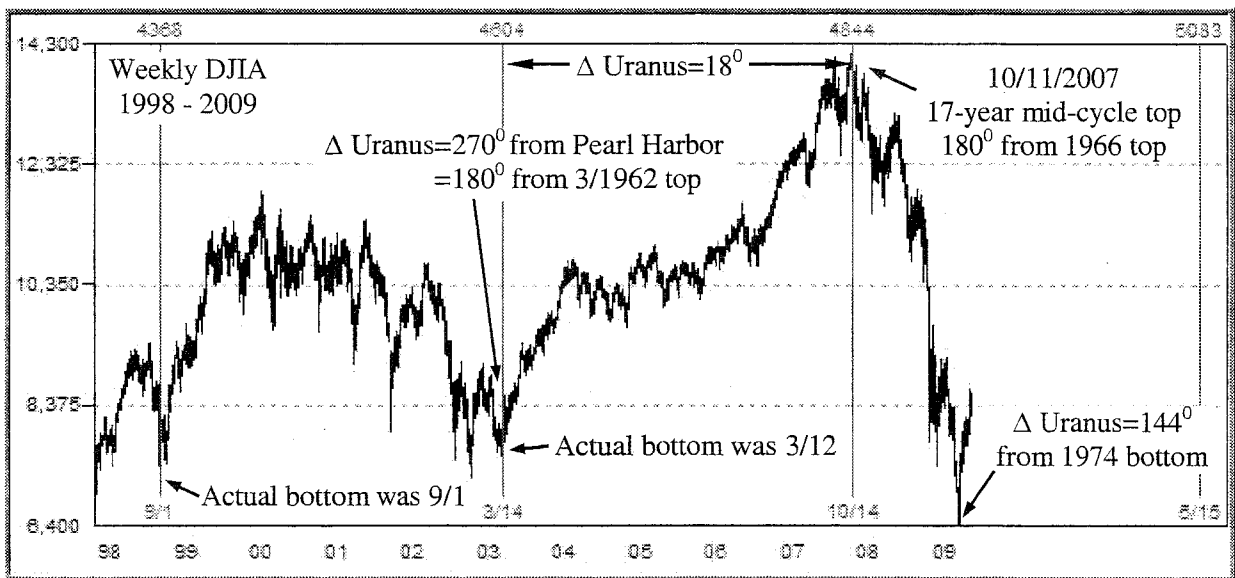
Remember when looking at the charts in this chapter that they all had the same origin nearly 100 years ago in 1914. The weekly time counts from 1914 are printed along the top of the charts.

### URANUS 18° HARMONICS BETWEEN 1998-2012

Chart 6.1 shows the  $\Delta$  Uranus=18° cycles between 1998 and 2007. All cycles were accurate to within 1-2 trading days. The September 1, 1998 bottom was exactly 360° from the reopening of the NYSE on 12/12/1914, accurate to the day.

March 12, 2003 was the final bottom leading to the 5-year bull cycle to 2007. This bottom aligned within 1-2 trading days of the ideal cycle. It was also the 90° Uranus quarter-cycle explained in *Appendix I*. 90° Uranus back from March 2003 was August 1981, the exact top in the SP500. Prior to 1981 the 90° harmonic arrived at the 1962 panic. The attack on Pearl Harbor was 270° from March 2003. One complete Uranus cycle from March 2003 was the top at the Saturn-Uranus opposition in June 1919.

October 11, 2007 was the mid-cycle top in the 2000-2017 cycle,  $\Delta$  Uranus=180° from the 1966 top. It completed the 5-year cycle from October 10, 2002. The actual top aligned within 1 trading day of the  $\Delta$  Uranus=18° cycle from 12/12/1914.



**Chart 6.1**

$\Delta$  Uranus=18° cycles, 1998-2007. Origin is the 12/12/1914 NYSE reopening.



The weekly time counts along the top of the chart show the time between the cycles was 236 weeks, or 54.5 months, or 4.5 years. The next axis is May 15, 2012. This aligns

well with the typical May seasonal turning date. Later chapters will show that the 13-year cycle is due in May 2013, one year after the expected Uranus 18<sup>0</sup> cycle.

Axis	Planet	Longitude	Date	Hour	Minute	Change	Change (From Start)	Calendar Days
0	Uranus	311°04'35.494"	12/12/1914	0	0	N/A	N/A	0
1	Uranus	329°04'35.494"	6/25/1919	14	44.69	18°00'00.000"	18°00'00.000"	1656.61437
2	Uranus	347°04'35.494"	1/28/1924	4	39.05	18°00'00.000"	36°00'00.000"	3334.19379
3	Uranus	5°04'35.494"	8/29/1928	13	42.48	18°00'00.000"	54°00'00.000"	5009.57117
4	Uranus	23°04'35.494"	3/19/1933	2	10.27	18°00'00.000"	72°00'00.000"	6672.09046
5	Uranus	41°04'35.494"	9/11/1937	14	37.55	18°00'00.000"	90°00'00.000"	8309.60941
6	Uranus	59°04'35.494"	1/25/1942	7	59.77	18°00'00.000"	108°00'00.000"	9906.33317
7	Uranus	77°04'35.494"	4/28/1946	7	37.57	18°00'00.000"	126°00'00.000"	11460.31776
8	Uranus	95°04'35.494"	6/17/1950	8	50.9	18°00'00.000"	144°00'00.000"	12971.36868
9	Uranus	113°04'35.494"	6/23/1954	8	51.17	18°00'00.000"	162°00'00.000"	14438.36887
10	Uranus	131°04'35.494"	5/25/1958	8	56.84	18°00'00.000"	180°00'00.000"	15870.37281
11	Uranus	149°04'35.494"	4/4/1962	1	42	18°00'00.000"	198°00'00.000"	17280.07083
12	Uranus	167°04'35.494"	1/28/1966	6	23.8	18°00'00.000"	216°00'00.000"	18675.26653
13	Uranus	185°04'35.494"	11/18/1969	3	26.67	18°00'00.000"	234°00'00.000"	20065.14352
14	Uranus	203°04'35.494"	9/18/1973	11	16.29	18°00'00.000"	252°00'00.000"	21465.46965
15	Uranus	221°04'35.494"	8/13/1977	5	44.49	18°00'00.000"	270°00'00.000"	22890.23923
16	Uranus	239°04'35.494"	8/6/1981	22	6.84	18°00'00.000"	288°00'00.000"	24344.92142
17	Uranus	257°04'35.494"	9/6/1985	11	13.03	18°00'00.000"	306°00'00.000"	25836.46738
18	Uranus	275°04'35.494"	11/22/1989	14	37.29	18°00'00.000"	324°00'00.000"	27374.60923
19	Uranus	293°04'35.494"	3/24/1994	23	2.02	18°00'00.000"	342°00'00.000"	28957.95974
20	Uranus	311°04'35.494"	9/1/1998	0	12.97	18°00'00.000"	360°00'00.000"	30579.009
21	Uranus	329°04'35.494"	3/14/2003	7	47.07	18°00'00.000"	378°00'00.000"	32234.32436
22	Uranus	347°04'35.494"	10/14/2007	9	36.12	18°00'00.000"	396°00'00.000"	33909.40008
23	Uranus	5°04'35.494"	5/15/2012	16	45	18°00'00.000"	414°00'00.000"	35584.69792
24	Uranus	23°04'35.494"	12/7/2016	8	8.69	18°00'00.000"	432°00'00.000"	37251.33937
25	Uranus	41°04'35.494"	6/4/2021	22	15.39	18°00'00.000"	450°00'00.000"	38891.92736
26	Uranus	59°04'35.494"	10/20/2025	15	8.5	18°00'00.000"	468°00'00.000"	40490.6309
27	Uranus	77°04'35.494"	1/25/2030	2	45.88	18°00'00.000"	486°00'00.000"	42048.11519
28	Uranus	95°04'35.494"	3/20/2034	1	28.44	18°00'00.000"	504°00'00.000"	43563.06142
29	Uranus	113°04'35.494"	3/28/2038	15	45.16	18°00'00.000"	522°00'00.000"	45032.65636
30	Uranus	131°04'35.494"	3/1/2042	7	24.09	18°00'00.000"	540°00'00.000"	46466.3084
31	Uranus	149°04'35.494"	1/9/2046	6	54.09	18°00'00.000"	558°00'00.000"	47876.28756
32	Uranus	167°04'35.494"	11/3/2049	13	55.13	18°00'00.000"	576°00'00.000"	49270.57995
33	Uranus	185°04'35.494"	8/23/2053	23	33.89	18°00'00.000"	594°00'00.000"	50659.98187
34	Uranus	203°04'35.494"	6/24/2057	0	38.01	18°00'00.000"	612°00'00.000"	52060.0264
35	Uranus	221°04'35.494"	5/16/2061	6	49.13	18°00'00.000"	630°00'00.000"	53482.28412
36	Uranus	239°04'35.494"	5/5/2065	15	42.93	18°00'00.000"	648°00'00.000"	54932.65481
37	Uranus	257°04'35.494"	6/2/2069	6	7.72	18°00'00.000"	666°00'00.000"	56421.25536
38	Uranus	275°04'35.494"	8/16/2073	10	42.11	17°59'59.999"	684°00'00.000"	57957.44591
39	Uranus	293°04'35.494"	12/13/2077	5	7.88	18°00'00.000"	702°00'00.000"	59537.21381
40	Uranus	311°04'35.494"	5/18/2082	12	43.49	18°00'00.000"	720°00'00.000"	61154.5302

Table 6.1

$\Delta$  Uranus=18<sup>0</sup> cycles 1914 - 2082.

**URANUS 18<sup>0</sup> HARMONICS  
BETWEEN 1981-1994**

The collapse in prices in the third quarter of 1981 aligned well with the Uranus axis. The 6/25/1981 top was already shown to align with the attack on Pearl Harbor. The 8/6/1981 top in the SP500 aligns to the day to the 12/12/1914 axis shown above. The price decline continued into September 1981, then the market moved sideways until completion of the 17-year cycle in August 1982.

The remainder of the chart is during the powerful 1982-2000 17-year up cycle. Halfway through the 1982-1987 5-year cycle the Uranus 18<sup>0</sup> axis in 9/1985 accelerated prices to the top.

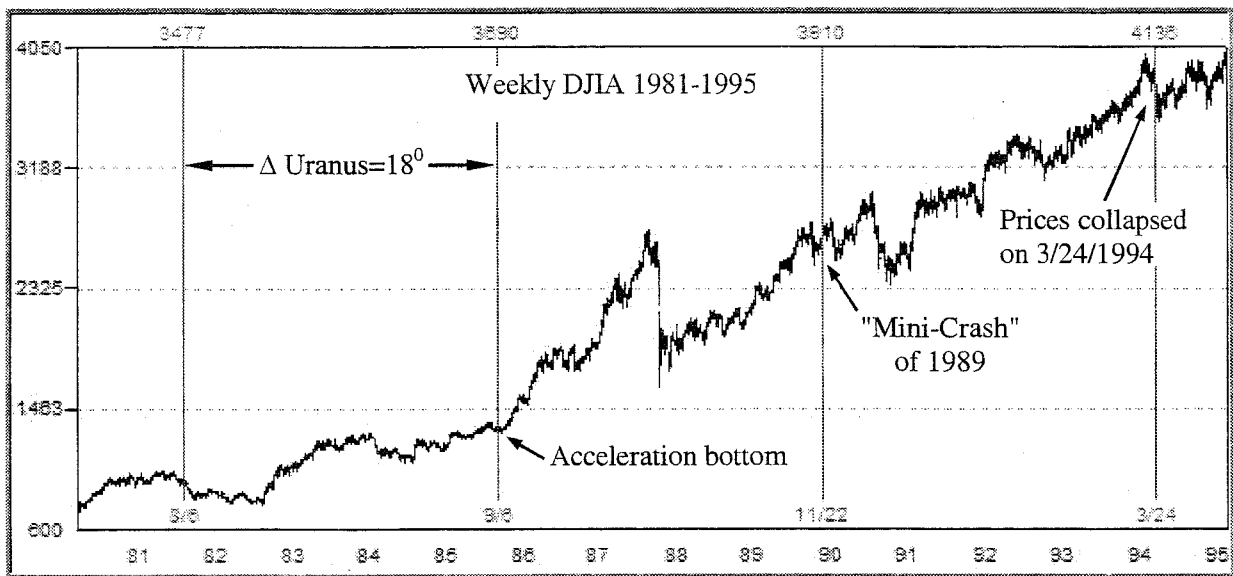
The 3/24/1994 top was accurate to the day. The reader can look at these dates on his own daily charts for a better understanding of how accurate these cycles were. 1994 has special significance because it marks the acceleration bottom of the 5-year cycle

completing the 17-year cycle in 2000. Later chapters will use pentagonal cycle expansion theory to explain how this bottom aligned with the 1924-1929 5-year cycle.

**URANUS 18<sup>0</sup> HARMONICS  
BETWEEN 1966-1981**

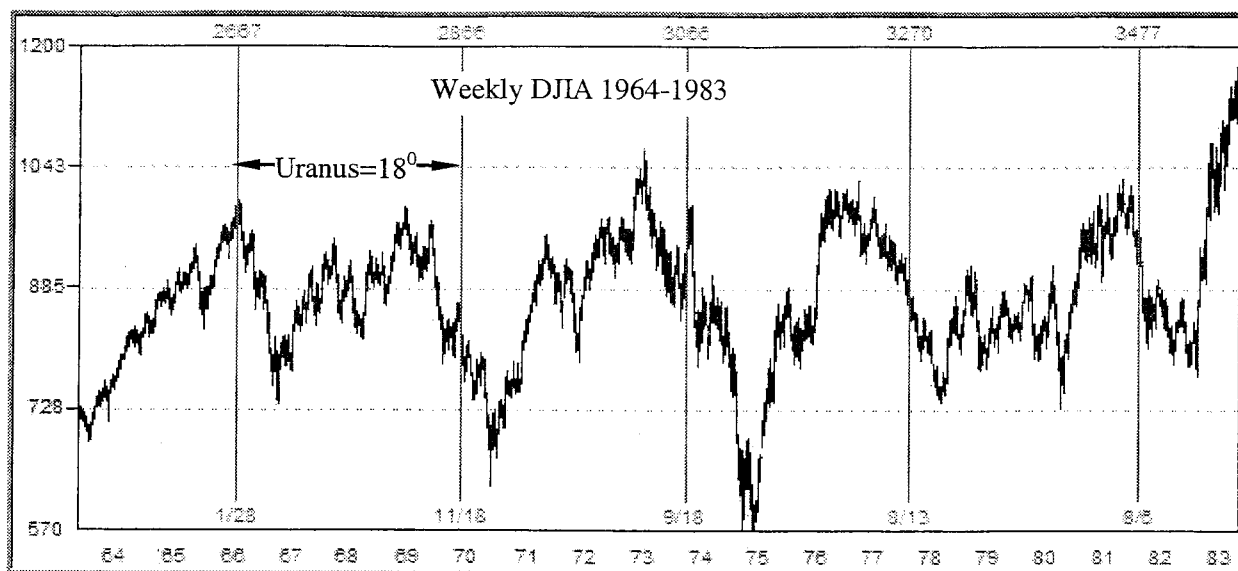
After the huge bull market from 1949 the stock market stopped on a dime in late January 1966, making a double top in early February. The bull was dead. Most investors and traders had no idea of the difficult times they would face for the next 17 years. The 1966-1982 17-year cycle moved sideways in a choppy nerve-wracking pattern. Investors who held during this 17-year period lost money. Moreover, it was not a slow bleeding. Several times during this period prices were cut in half, then doubled, only to be cut in half again.

This kind of price instability for nearly a generation can make many long-term investors lose their patience and abandon stock investing entirely. When the public



**Chart 6.2**

$\Delta \text{Uranus} = 18^0$  cycles, 1981-1994. Origin is the 12/12/1914 NYSE reopening.



**Chart 6.3**

$\Delta$  Uranus= $18^\circ$  cycles, 1966-1981. Origin is the 12/12/1914 NYSE reopening.

has finally given up on stock investing the foundation has been laid for a major advance, such as after 1982.

1966 is best described as a time of child-like irresponsibility. The "buy now – pay later" philosophy during the speculative frenzy of the 1920s had decayed even further to a mantra of "give it to me free and I never pay". Hippie communes, drug abuse, and war protests were rampant. These emotional extremes all fit well into the climactic top of a post-war bull market.

The beginning and ending cycles in Chart 6.3 are the most interesting, spanning four complete  $18^\circ$  cycles, or  $72^\circ$ . The January 1966 cycle turned the long bull market into a bear. The August 1981 axis started the final one-year price collapse of this 17-year bear cycle. The cycles between these dates occurred during declines and marked brief price spikes or rapid acceleration of the downtrend, as in 1977.

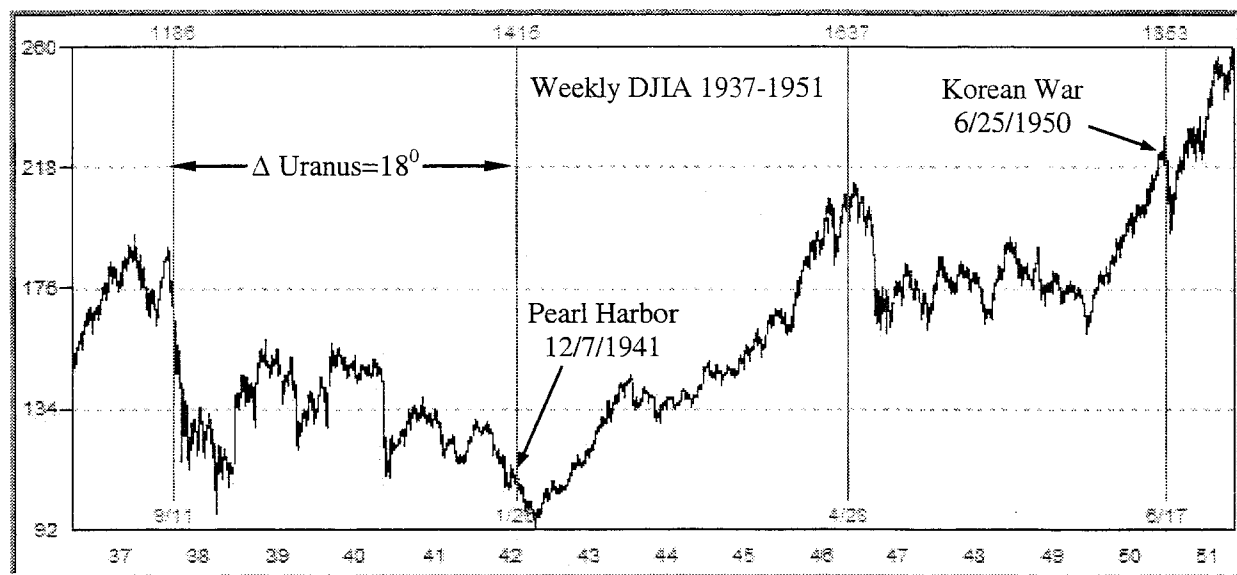
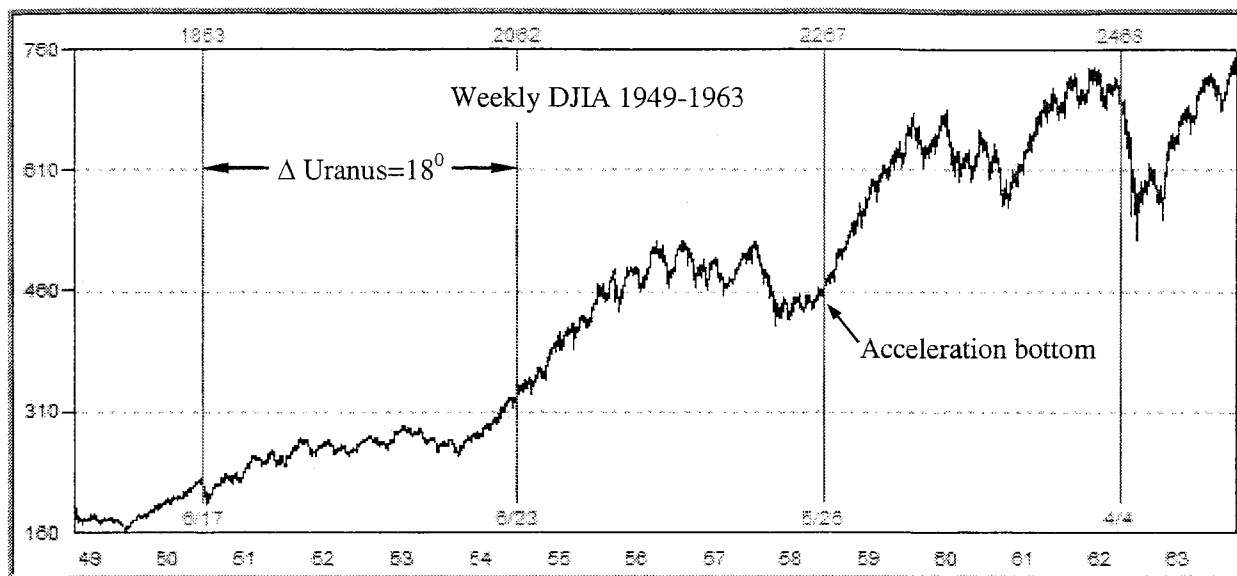
### *URANUS $18^\circ$ HARMONICS BETWEEN 1950-1962*

The 17-year bull cycle started in 1949. Prices continued to increase with only minor corrections until 1962 when the advance was interrupted by the 1962 panic sell-off at the Uranus  $90^\circ$  quarter-cycle top.

This  $90^\circ$  cycle is the 5<sup>th</sup> occurrence of the  $18^\circ$  cycle from Pearl Harbor in 1941. Projecting this  $90^\circ$  cycle once more into the future pinpoints the low in 2003,  $270^\circ$  from Pearl Harbor.

The mid-cycle acceleration bottom arrived on schedule in 1958,  $36^\circ$  from the start of the Korean War.

The 1950  $18^\circ$  axis coincided with the start of the Korean War and saw a quick and short-lived sell-off. Within a few weeks the market had recovered to its pre-war levels and the uptrend continued, as is typical of counter-trend sell-offs caused by news trauma.



**Chart 6.4**

Δ Uranus=18<sup>0</sup> cycles, 1937-1962. Origin is the 12/12/1914 NYSE reopening.

**URANUS 18<sup>0</sup> HARMONICS BETWEEN 1937-1950**

Chart 6.4 is fascinating to study because it includes four panics and two wars in such a short time period. All were accurately timed by the 18<sup>0</sup> Uranus cycle. Uranus is well known by traditional astrologers to be associated with wars.

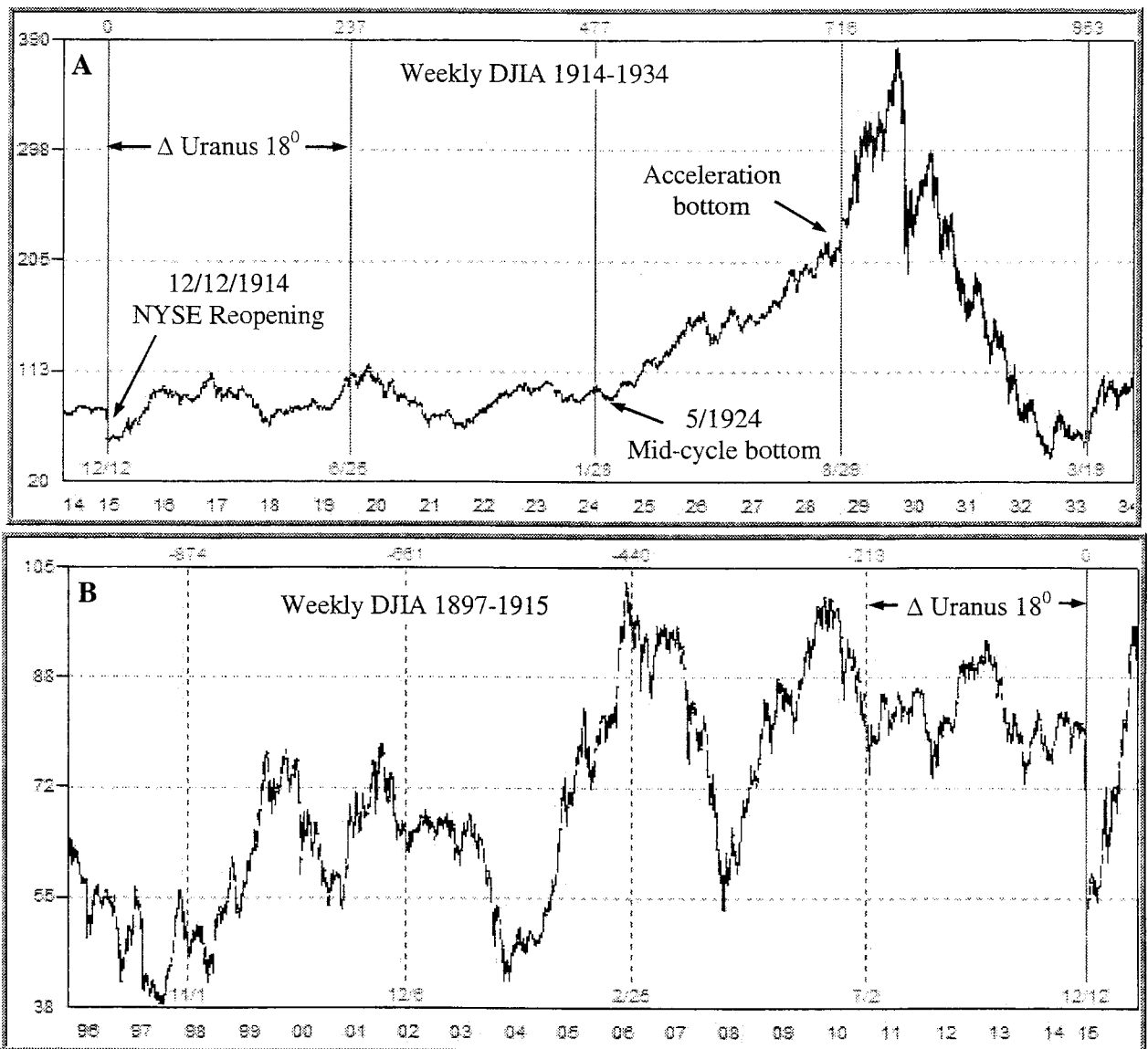
The first cycle on this chart coincided closely with the 1937 panic. After the 1929-1932 crash the stock market completed a 5-year 1932-1937 bull run, retracing 50% of the crash. When it became clear in 1937 that the economy was not recovering from the depression, prices again collapsed into a new 5-year bear market. The 1937 top was 90<sup>0</sup> Uranus from the 1914 reopening.

After Uranus moved  $18^{\circ}$  from the 1937 panic, Pearl Harbor was attacked by Japan on December 7, 1941, throwing the USA into World War II.

The 1946 top marked the end of the post-war boom and a brief period of peace before the cycle axis arrived again in 1950 at the start of the Korean War. The 1946-1950 period between the wars will be studied extensively in the chapter on Saturn and *The Great Pentagon*.

**URANUS  $18^{\circ}$  HARMONICS  
BETWEEN 1897-1933**

Charts 6.5.A and 6.5.B extend this cycle back to the Saturn-Uranus conjunction in 1897, completing 110 years since the 2007 top. Each of the cycles aligned well with significant turning points. The 1906 top leading to the "Rich Man's Panic" was closely timed as was the spike low in 1910 and the acceleration bottom in 1928 leading to that blow-off top.



**Chart 6.5**  
 $\Delta$  Uranus= $18^{\circ}$  cycles, 1897-1933. Origin is the 12/12/1914 NYSE reopening.

*The appearance of the wheels and their work was like unto the colour of a beryl: and they four had one likeness: and their appearance and their work was as it were a wheel in the middle of a wheel. ... Ezekiel 1:16*

Ezekiel was a 6<sup>th</sup> century BC prophet in the Hebrew Bible. A contemporary of Pythagoras in Europe and Lao Tzu (Tao Te Ching) in China he lived with the ancient Chaldeans in Babylonia, some of the greatest astrologers in history. Much of the symbolism and time periods used in the Book of Ezekiel can be found in astrological cycles.

### **SATURN-URANUS HARMONY**

In the 1930's James Mars Langham wrote two good books on market astro cycles, *Cyclical Market Forecasting Stocks and Grain* (1938), and *Planetary Effects on Stock Market Prices* (1932). He spent a considerable amount of time on Saturn and Uranus, calling Uranus "the market planet" in *Cyclical Forecasting*. Although his work focused on the traditional geocentric "natural" angles of 60<sup>o</sup>, 90<sup>o</sup>, and 120<sup>o</sup>, etc, it still provides a good source for background research done many years ago.

The analysis to this point has focused on Uranus because it is the "Market Master". The motion of this planet alone explains many of the major stock market trends and turns. However, adding the next planet closer to the Sun, Saturn, improves the analysis by providing confirmation of the Uranus cycles when they work together and by identifying other important cycles.

Previous chapters showed how the pentagonal 72<sup>o</sup> Uranus cycle aligned with the 17-year cycle. However, there were a

few "fuzzy" areas where there were double bottoms, such as 1932/1933 and 1949/1950. These will be explained in this chapter by adding the motion of Saturn. The analysis will start with the motion of Saturn relative to Uranus, called the synodic cycle. The synodic cycle will be correlated with the motion of Uranus, greatly improving the accuracy of the analysis. Then Saturn alone will be studied.

*Four-Dimensional Stock Market Structures And Cycles* and *Market Science* outlined the Saturn-Uranus cycles in the stock and soybean markets. This work will not repeat that analysis but will expand it to show how Saturn synchronizes with the 17-year pentagonal Uranus cycle and the Square of Twelve, 144.

### **SATURN-URANUS SYNODIC CLOCK**

The harmonious synchrony of Saturn and Uranus is not immediately apparent without a little closer study. The period of Uranus is approximately 84 years and the synodic cycle of Saturn-Uranus is 45 years. Therefore, two complete Saturn-Uranus cycles is 90 years, which does not coincide with the 84-year period of Uranus.

Table 7.1 shows the exact dates and locations of 16 Saturn-Uranus conjunctions ( $\sigma$ ) spanning 700 years between 1671 and 2351. Calculating several complete cycles is a good way to measure the actual synodic period averaged over many recurrences.

Axis	Planet	Longitude	Date	Hour	Minute	Synodic Angle	Change	Change (From Start)	Calendar Days
0	Saturn	340°20'05.203"	3/16/1671	16	2.78	0°00'00.000"	N/A	N/A	0
	Uranus	340°20'05.202"							
1	Saturn	168°13'54.529"	12/21/1714	4	44.04	0°00'00.000"	360°00'00.000"	360°00'00.000"	15984.52865
	Uranus	168°13'54.529"							
2	Saturn	6°42'48.352"	8/22/1761	11	14.47	0°00'00.000"	360°00'00.000"	720°00'00.000"	33030.79978
	Uranus	6°42'48.352"							
3	Saturn	202°42'31.979"	1/31/1806	0	47.13	0°00'00.000"	360°00'00.000"	1080°00'00.000"	49262.36413
	Uranus	202°42'31.979"							
4	Saturn	33°01'17.896"	12/25/1851	0	58.36	0°00'00.000"	360°00'00.000"	1440°00'00.000"	66026.37193
	Uranus	33°01'17.895"							
5	Saturn	236°44'54.709"	4/24/1897	17	21.9	0°00'00.000"	360°00'00.000"	1800°00'00.000"	82584.05494
	Uranus	236°44'54.709"							
6	Saturn	59°45'23.601"	3/25/1942	19	54.47	0°00'00.000"	360°00'00.000"	2160°00'00.000"	98989.1609
	Uranus	59°45'23.601"							
7	Saturn	268°55'40.585"	6/9/1988	16	13.2	0°00'00.000"	360°00'00.000"	2520°00'00.000"	115867.00724
	Uranus	268°55'40.585"							
8	Saturn	87°47'19.242"	7/20/2032	3	57.02	0°00'00.000"	360°00'00.000"	2880°00'00.000"	131978.496
	Uranus	87°47'19.242"							
9	Saturn	299°02'01.791"	5/28/2079	9	5.03	0°00'00.000"	360°00'00.000"	3240°00'00.000"	149091.7099
	Uranus	299°02'01.791"							
10	Saturn	117°34'06.192"	12/19/2122	1	36.83	0°00'00.000"	360°00'00.000"	3600°00'00.000"	165001.39864
	Uranus	117°34'06.192"							
11	Saturn	327°09'38.010"	2/16/2170	16	35.75	0°00'00.000"	360°00'00.000"	3960°00'00.000"	182228.02289
	Uranus	327°09'38.010"							
12	Saturn	149°35'43.317"	8/24/2213	13	24.34	0°00'00.000"	360°00'00.000"	4320°00'00.000"	198121.88997
	Uranus	149°35'43.316"							
13	Saturn	354°12'56.470"	9/15/2260	6	25.47	0°00'00.000"	360°00'00.000"	4680°00'00.000"	215310.59909
	Uranus	354°12'56.470"							
14	Saturn	183°28'06.687"	7/23/2304	10	43.07	0°00'00.000"	360°00'00.000"	5040°00'00.000"	231326.77798
	Uranus	183°28'06.687"							
15	Saturn	20°37'13.207"	2/20/2351	21	12.08	0°00'00.000"	360°00'00.000"	5400°00'00.000"	249340.21479
	Uranus	20°37'13.207"							

Table 7.1

Dates and times (GMT) of Saturn-Uranus Conjunctions - 1671 A.D. to 2351 A.D.

The table shows that 15 cycles lasted 248,340 calendar days, giving an average synodic period for Saturn-Uranus of:

$$248,340 / 15 / 365.24 = 45.33 \text{ years.}$$

Figure 7.1 reveals the harmony of these Saturn-Uranus conjunctions when their locations are plotted on the same zodiac chart.

Beginning with the 1897 conjunction at 237° in the upper right location of Figure 7.1 (#1), and moving to the next conjunction in 1942 (#2), the two planets moved to the opposite side of the circle, or 180°. Because this took 45 years Saturn moved around the circle 1½ times and Uranus ½. If this pattern

continued with successive conjunctions always separated by 180° the pattern would simply oscillate back and forth at the same two opposing zodiac locations and it would not be much of a clock.

The next conjunction (#3) occurred in 1988 at 269°. It again moved to the other side of the zodiac plus an additional 30°, placing it 30° from the 1897 (#1) conjunction.

After the 1988 conjunction, the next one (#4) occurred at 88° or 180° from the previous conjunction. Conjunction #5 occurred at 299°, or 30° from the 1988 conjunction, and so on.

The pattern is now apparent. A conjunction occurs  $180^\circ$  from the previous one, and the next one moves  $180^\circ + 30^\circ$ . This means every two conjunctions of 90 years moves one complete circle around the zodiac plus an additional  $30^\circ$ , or one sign. During this 90-year conjunction cycle Saturn completes three  $360^\circ$  orbits or  $1,080^\circ$ , plus an additional  $30^\circ$ .

As these conjunctions move around the zodiac it takes about 500 years or 11 conjunctions for the cycle to move all the way around  $360^\circ$  where a conjunction again takes place in approximately the same location.

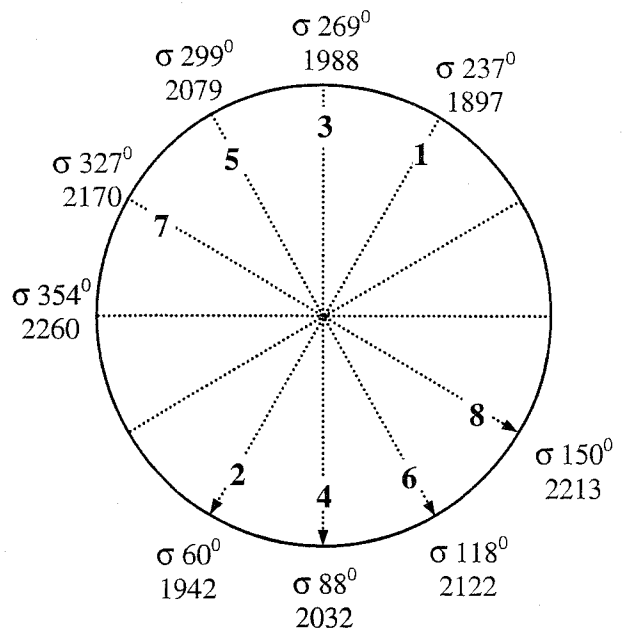
**ELLIPTICAL ORBITS CAUSE SYNODIC CYCLES TO VARY**

The elliptical orbits of the planets cause them to move at changing speeds and for the pattern of conjunctions to rotate around the zodiac. Table 7.1 shows that the time between the 1897-1942 conjunctions was 16,405 days (44.92 years). The time between the 1942-1988 conjunctions was 16,878 days (46.21 years).

Chart 7.1 plots the speed of Uranus below the monthly DJIA. The speed was slowest between the 1897-1942 conjunctions. When Uranus is slow Saturn catches up with it sooner hence, the distance traveled in the zodiac between conjunctions is less than when Uranus is moving faster. When Uranus is moving faster it takes more degrees for Saturn to catch up with it hence, the additional sign ( $180^\circ + 30^\circ$ ) between the 1942 and 1988 conjunctions.

**SATURN-URANUS AND THE 17-YEAR CYCLE**

Uranus has already been shown to move  $72^\circ$  during one 17-year cycle. The average



**Figure 7.1**  
Saturn-Uranus conjunctions 1897-2260

motion of Saturn relative to Uranus during this same time is  $135^\circ$ .<sup>21</sup>

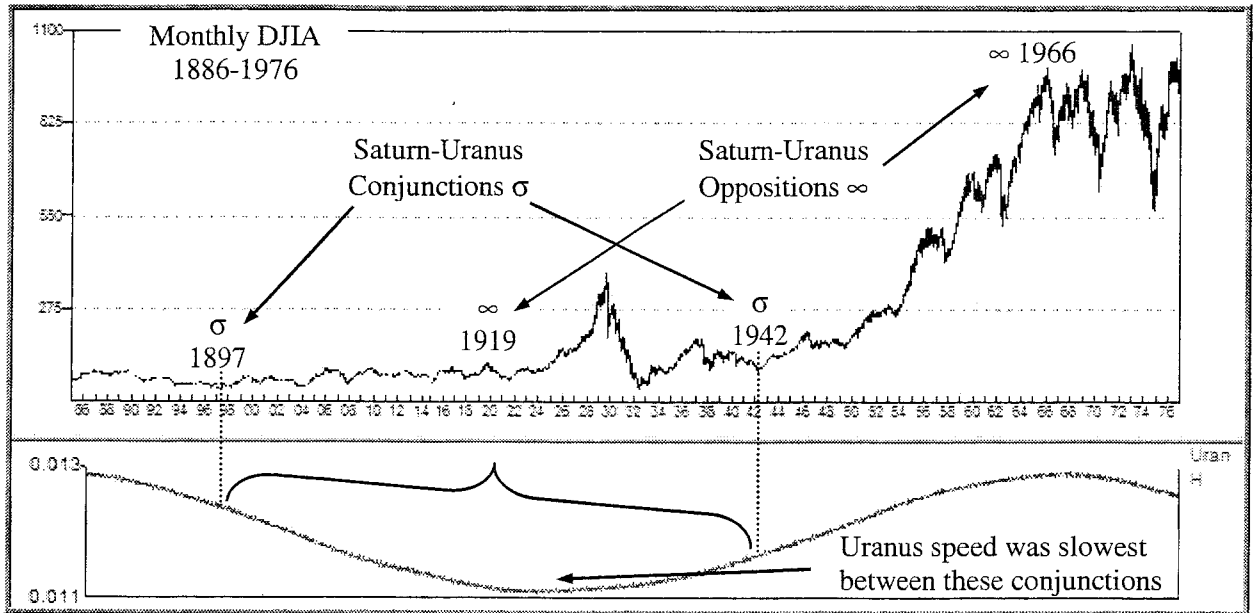
$$\frac{17 \text{ years}}{45 \text{ years}} \times 360^\circ = 136^\circ$$

Careful measurements show that the planet's changing speed often causes Saturn-Uranus to move  $144^\circ$  during the 17-year cycle. This concept is critically important and explains why it is a mistake to try to explain the 17-year cycle, and others, by simply running  $\Delta$  Saturn-Uranus= $135^\circ$  across the chart uninterrupted for several complete cycles.

Figure 7.2 shows the motion of Saturn and Uranus during eight 17-year cycles from

<sup>21</sup> L. Peter Cogan briefly mentioned in *Rhythmic Cycles of Optimism and Pessimism* that the 17-year cycle was  $3/8$ , or  $135^\circ$ , of the 45-year Saturn-Uranus synodic cycle. He did not try to explain more about this correlation.





**Chart 7.1**

Uranus speed plotted below monthly DJIA with Saturn-Uranus conjunctions.

1897 to 2033.<sup>22</sup> This is a very helpful diagram to study because it shows at a glance where both the Uranus and Saturn-Uranus cycles were during all these cycles.

The top row of circles numbered 1-4 are the synodic Saturn-Uranus movements during the 17-year cycle. They do not indicate where in the zodiac these two planets were during these movements. For example, the first circle shows Saturn-Uranus moving from conjunction  $0^0$  to  $137^0$  between 1897-1914. The  $0^0$  shown in the diagram is not  $0^0$  Aries. In fact, that conjunction occurred at  $237^0$  in the zodiac.

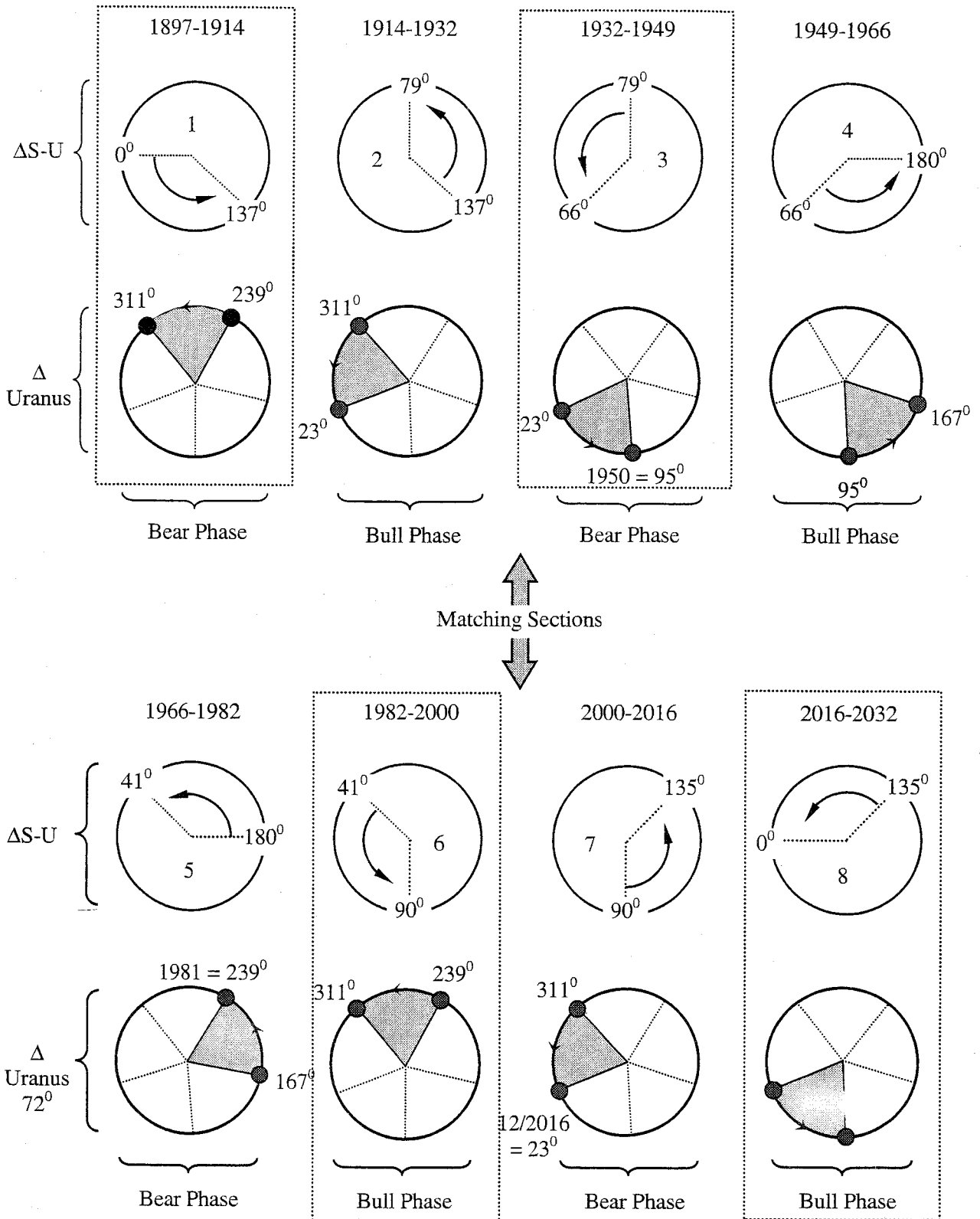
Directly below these four circles is the location of Uranus during the same 17-year cycles. The first cycle 1897-1914 shows

<sup>22</sup> Future dates are approximate to demonstrate the analysis. The reader must do his own calculations to arrive at the projected cycle dates.

Uranus moved from  $237^0$  to  $311^0$ . This 17-year cycle is identified as a "Bear Phase".

Between 12/12/1914 and the second bottom in 1933 Uranus moved from  $311^0$  to  $23^0$  for a total of  $72^0$ . Starting at this same 12/12/1914 date and measured to the first bottom on 7/8/1932 the angle between Saturn and Uranus changed from  $137^0$  through the  $180^0$  opposition and down to  $79^0$ , for a total change during the cycle of  $143^0 16'$ . This 17-year cycle was in a "Bull Phase". The Uranus and Saturn-Uranus cycles arrived at slightly different dates explaining the double bottom in 1932-1933.

The four pairs of cycles at the bottom of Figure 7.2 continue this process until 2032. There are a total of eight cycles until Saturn-Uranus conjoin ( $0^0$ ) again at the end of a 17-year cycle in 2032. Eight  $135^0$  cycles is  $1,080^0$ , or three complete 45-year Saturn-Uranus cycles. There were two other



**Figure 7.2**  
 $\Delta$  Uranus = 72° and  $\Delta$  Saturn-Uranus = 135° (average) during 17-year cycles.

conjunctions during this time, in 1942 and 1988, but none that coincided with the end of a 17-year cycle until the conjunction in 2032.

The diagram shows that when the third conjunction is reached in 2032, Uranus will have returned to its same location as at the 1949 bottom, which was  $30^{\circ}$  from the 1942 conjunction bottom. As shown in Figure 7.1, the Saturn-Uranus clock has to tick one sign of  $30^{\circ}$  between the 1942 and 2032 conjunctions.  $30^{\circ}$  Uranus separated the 1942-1949 bottoms. It is recommend the reader review the location of the 1942 conjunction in Figure 7.1 and notice that ticking the clock one sign from 1942 puts Uranus at the 1949 bottom, the same location as the 2032 conjunction.

Figure 7.2 introduces another valuable concept. The four pairs of cycles on the bottom are matching sections with the four pairs on the top. This concept will be explored in detail later in the chapter *Repeating Market Patterns*. Briefly, what it means is that the market action during one of the 17-year cycles on the top row matches the action during the cycle below it, 1897-1914 matches 1966-1982, etc. This concept was introduced in *Four-Dimension Stock Market Structures And Cycles* where a 67-year offset was shown to correspond with similar faces on a cubic structure.

Uranus was  $237^{\circ}$  at the 1897 conjunction and  $240^{\circ}$  in 1982, or one complete cycle. Five points of the Uranus pentagram were defined between 1897-1966. Saturn-Uranus was  $0^{\circ}$  in 1897 and  $180^{\circ}$  in 1966 meaning the Saturn-Uranus cycle moved  $1\frac{1}{2}$  cycles or  $540^{\circ}$  during this time.  $540^{\circ}$  is the total of the outer angles of a pentagon ( $108^{\circ} \times 5 = 540^{\circ}$ ). This means  $72^{\circ}$  Uranus sidereal movements define the inner angles of the pentagram.

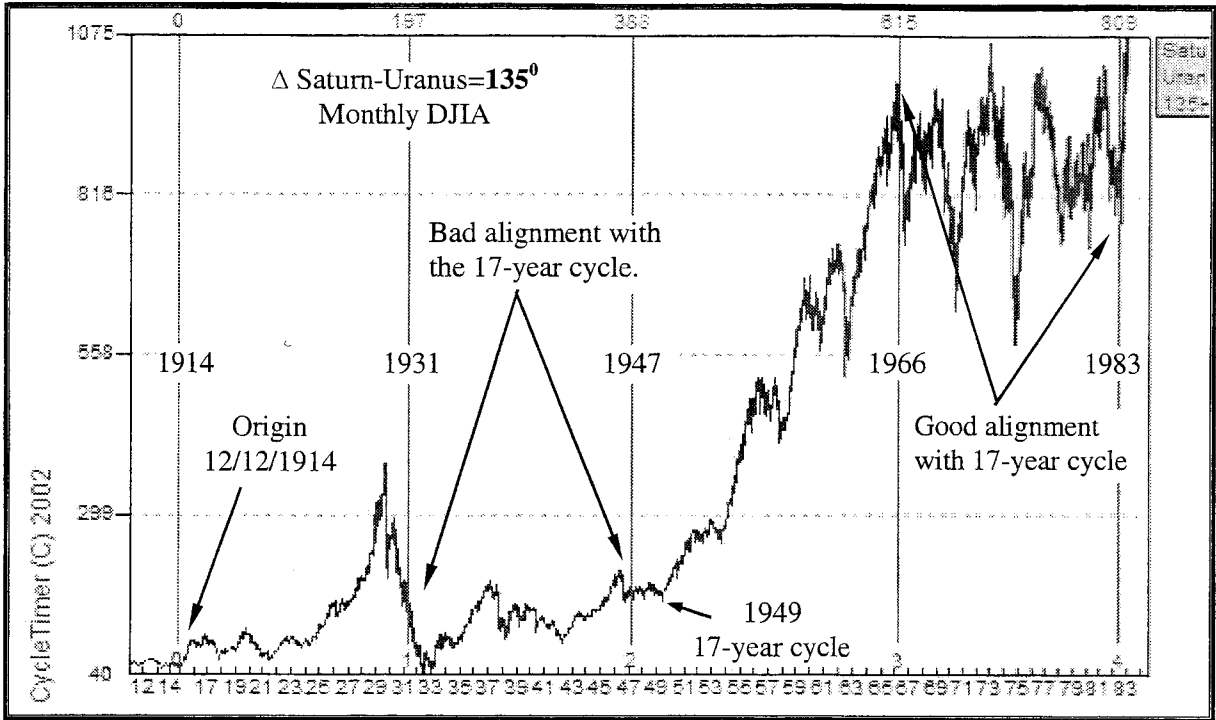
Five points of the pentagram are defined when Uranus moves  $72^{\circ}$  four times or  $288^{\circ}$ . At the same time synodic Saturn-Uranus moves  $540^{\circ}$  defining the outer angles of the pentagon. This process averages 67 years and corresponds with repeating stock market patterns, explored in detail in the chapter *Repeating Market Patterns*.

### **SYNCHRONIZING SATURN-URANUS WITH THE URANUS PENTAGRAM**

Chart 7.2 tests the correlation of  $\Delta$  Saturn-Uranus= $135^{\circ}$  with the 17-year cycle by plotting it with the DJIA starting in 1914. The results show that sometimes  $135^{\circ}$  correlates well with the 17-year cycle and sometimes it does not, such as at the 1932 and 1949 bottoms. Even if the cycle originates at the 1932 or 1933 bottoms there is no alignment with the 1949 bottom. However, the next two  $135^{\circ}$  cycles, 1966 and 1982, align very closely with the 17-year cycle.

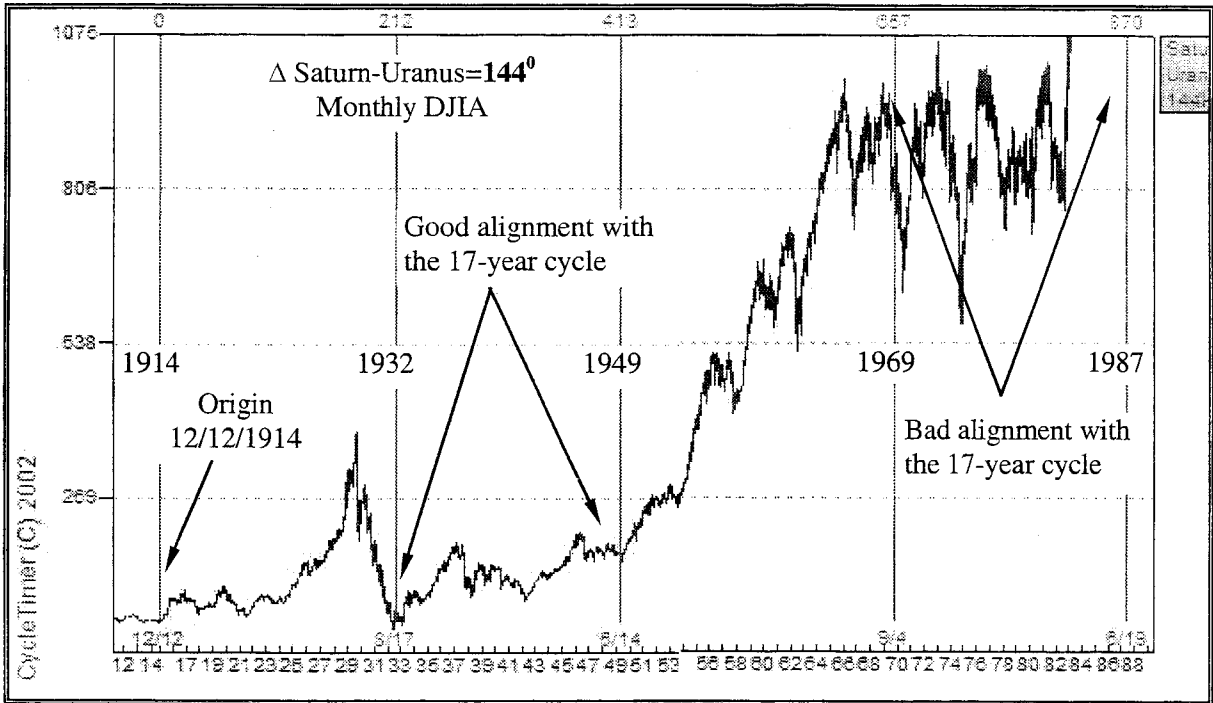
If the cycle is extended further in time the 2000 top aligns well with the fifth recurrence of the  $135^{\circ}$  cycle originating in 1914. The conclusion is that the  $135^{\circ}$  cycle alone is not a reliable indicator of the 17-year cycle. It's larger harmonics, such as the conjunction in 1897 and opposition in 1966, provide the best correlation with the pentagonal 17-year Uranus cycles.

If the Square of Twelve,  $144^{\circ}$ , is used instead of  $135^{\circ}$  the correlation with the 17-year cycle at the 1932 and 1949 bottoms is nearly perfect, but not at the 1897, 1966, 1982, or 2000 points. The two  $144^{\circ}$  cycles after 1966 align with major market turns, such as the 1969 top and within two months of the 1987 crash top, but not with the ideal 1966 and 1982 17-year cycles.



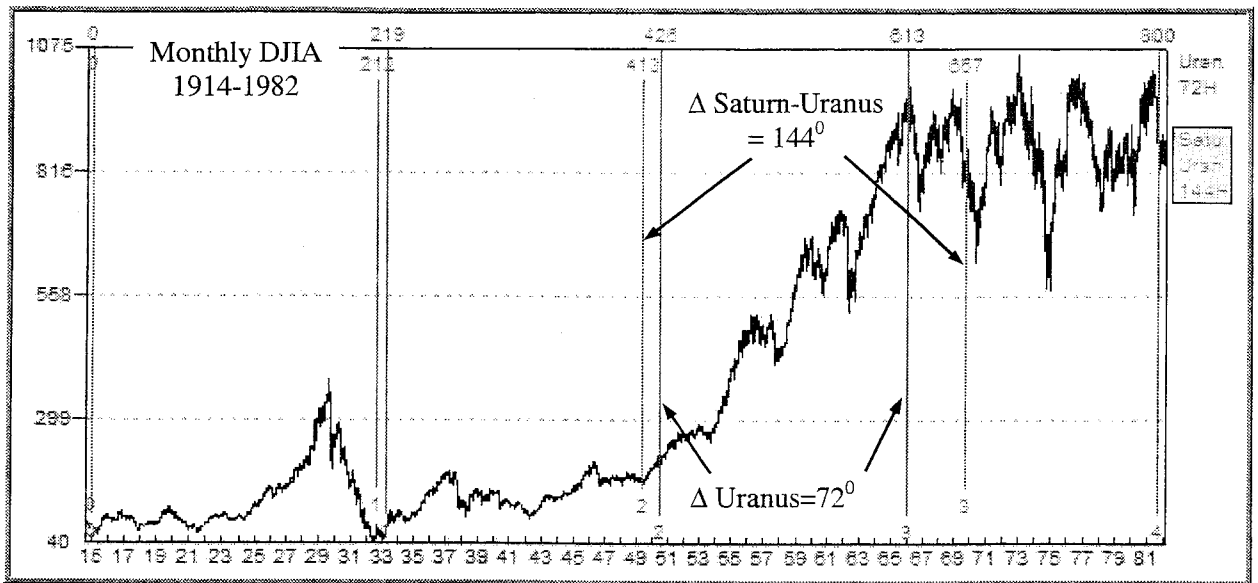
**Chart 7.2**

$\Delta$  Saturn-Uranus= $135^\circ$  in monthly DJIA. Origin is the 12/12/1914 reopening.



**Chart 7.3**

$\Delta$  Saturn-Uranus= $144^\circ$  in monthly DJIA. Origin is the 12/12/1914 reopening.



**Chart 7.4**

$\Delta$  Saturn-Uranus= $144^{\circ}$  alignment with  $\Delta$  Uranus= $72^{\circ}$

Chart 7.4 plots both the  $\Delta$  Saturn-Uranus= $144^{\circ}$  and the  $\Delta$  Uranus= $72^{\circ}$  cycles with their origin at 12/12/1914. All the cycles aligned with major turns even when not synchronized. The double bottoms in 1932 and 1933 coincided perfectly with these two cycles, as did the 1949 and 1950 double bottoms. The two cycles were together at these dates and aligned with clearly defined 17-year cycles.

The cycles separated at the 1966 top.  $\Delta$  Uranus= $72^{\circ}$  turned the market down in 1966 but the Saturn-Uranus= $144^{\circ}$  continued on until 1969 when prices collapsed. A similar situation occurred at the Uranus 1981 top and the Saturn-Uranus 1987 crash.

The conclusion is that the two cycles were out of phase after 1949. Timing the beginning and ending points of the 17-year cycle with Saturn-Uranus= $144^{\circ}$  shows good

results for the 1914-1932 and 1932-1949 cycles but the 1897-1914, 1966-1982, 1982-2000 sections were very close to  $135^{\circ}$ .

The speed of Uranus shown in Chart 7.5 explains why the  $135^{\circ}$  cycle sometimes aligns with  $\Delta$  Uranus= $72^{\circ}$  and sometimes it is  $144^{\circ}$ . The elapsed time between  $135^{\circ}$  cycles is much less when Uranus is traveling slower, i.e., further away from the sun, than when it is closer to the sun and moving faster. A slow Uranus allows Saturn to catch up with it much sooner in their orbits. When this happens it requires the full  $144^{\circ}$  of Saturn-Uranus to align with the  $\Delta$  Uranus= $72^{\circ}$  17-year cycle. The cycle extends to  $144^{\circ}$  to align with the Uranus cycle then later returns to  $135^{\circ}$ . The elliptical nature of their orbits causes this phase shift between the  $\Delta$  Saturn-Uranus= $135^{\circ}$  and  $\Delta$  Uranus= $72^{\circ}$  cycles.

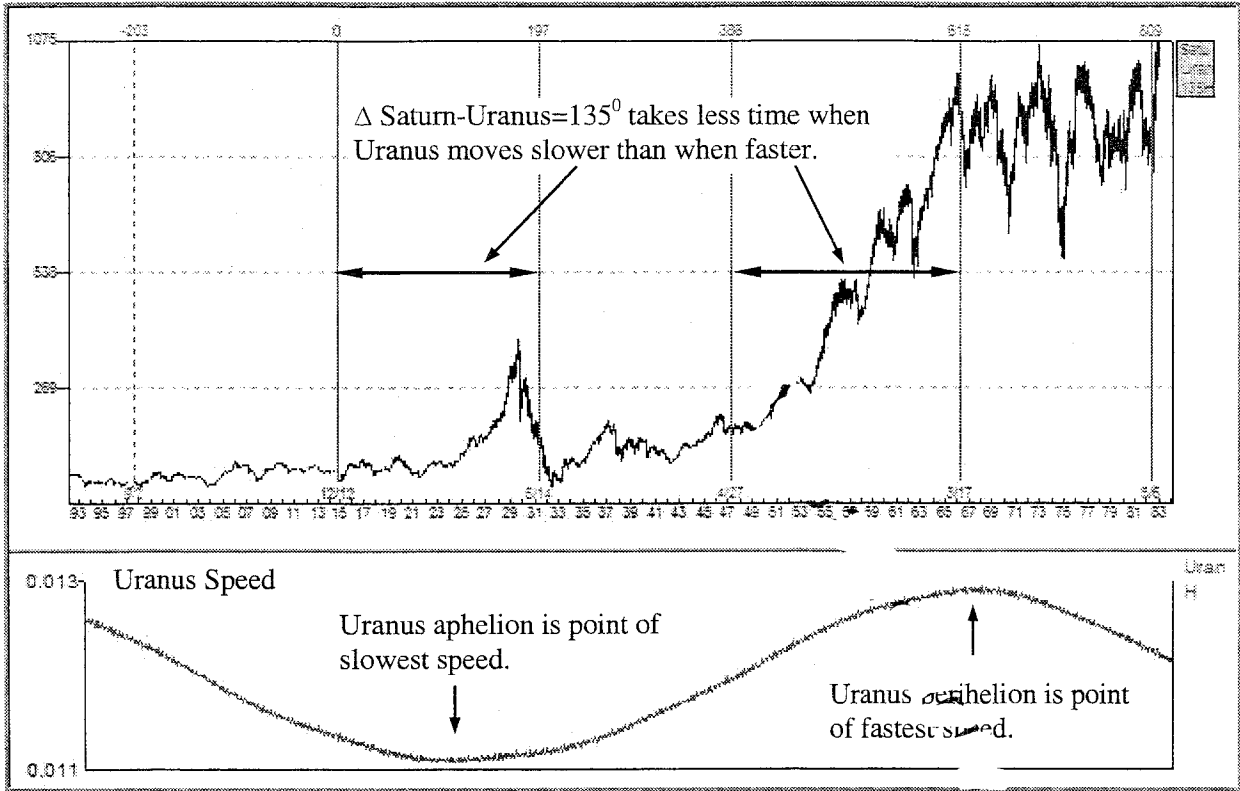


Chart 7.5

$\Delta \text{ Saturn-Uranus}=135^\circ$  occurs sooner when Uranus is moving slowly.

Plotting all three cycles together helps clarify this concept. In Chart 7.6 the  $\Delta \text{ Uranus}=72^\circ$ ,  $\Delta \text{ Saturn-Uranus}=135^\circ$ , and  $\Delta \text{ Saturn-Uranus}=144^\circ$  cycles are all plotted together. They all start at the reopening in 12/12/1944. The  $144^\circ$  cycle is discontinued after 1949 when it became out of phase with the  $\Delta \text{ Uranus}=72^\circ$  cycle. The  $135^\circ$  cycle is shown after 1949 because it is the cycle in phase with  $\Delta \text{ Uranus}=72^\circ$  after that date. Remember that all three cycles still have the same origin in 12/12/1944.

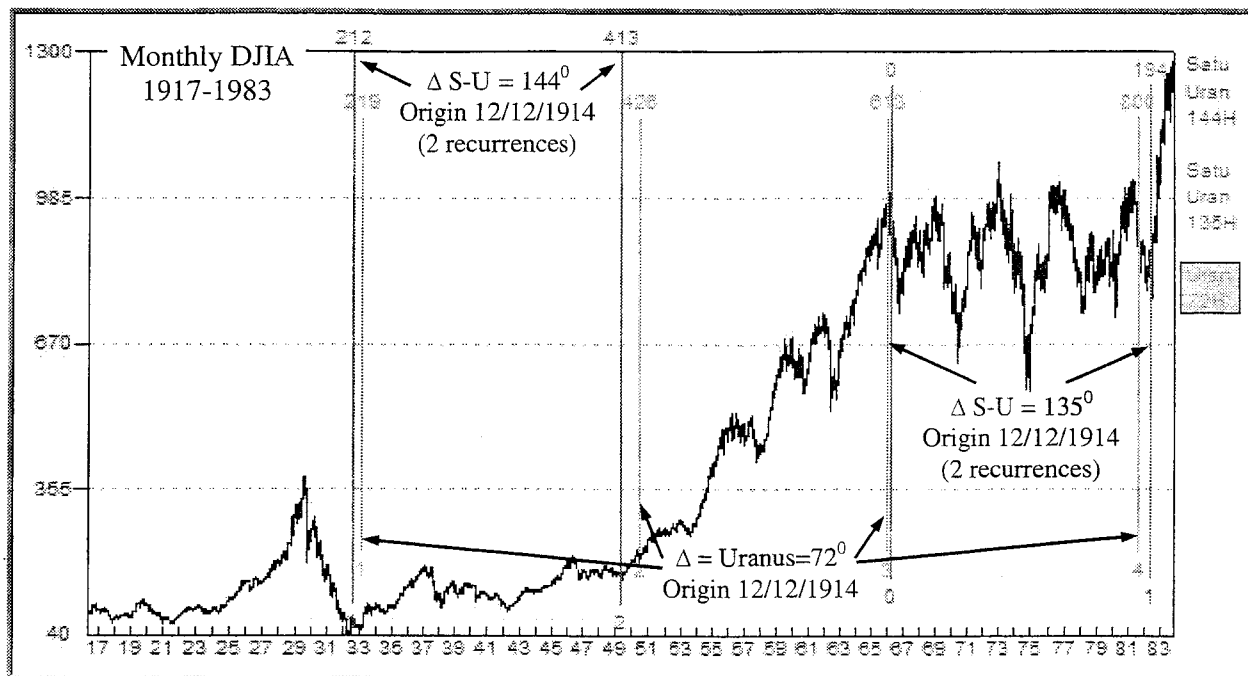
The conclusion is that using the  $\Delta \text{ Uranus}=72^\circ$  cycle alone is very close to explaining the 17-year cycle, but there are dates that go unexplained, such as the double bottoms in 1932 and 1933, the double bottoms in 1949 and 1950, and the collapse in 1981 and bottom in 1982. When

Uranus is combined with Saturn-Uranus the 17-year timing is improved.

Sidereal Saturn will be studied later to vastly improve timing this and other cycles.

**TIMING THE 2000-2017 CYCLE WITH SATURN-URANUS**

Although the  $\Delta \text{ Saturn-Uranus}=135^\circ$  cycle is not reliable in itself to time the beginning or end of any individual 17-year cycle, the harmonics provide a good tool to time turns within corresponding cycles. The harmonics are even multiples such as  $135^\circ \times 2 = 270^\circ$ ,  $135^\circ \times 4 = 540^\circ$ ,  $135^\circ \times 6 = 810^\circ$ . The even harmonics are used because the 17-year cycle has an up cycle and a down cycle. Corresponding up or down cycles are separated by even multiples of  $135^\circ$ .



**Chart 7.6**

$\Delta$  Uranus= $72^{\circ}$ ,  $\Delta$  Saturn-Uranus= $135^{\circ}$  (> 1949),  $\Delta$  Saturn-Uranus= $144^{\circ}$  (< 1950), showing the Saturn-Uranus phase shift. Origin of all three cycles is 12/12/1914.

Chart 7.7 uses the  $\Delta$  Saturn-Uranus= $270^{\circ}$  harmonic to compare the 17-year cycle after 2000 with the previous 17-year cycle in the down phase, 1966-1982. At the time of this writing in 2009, the 17-year cycle that began in 2000 is about halfway through.

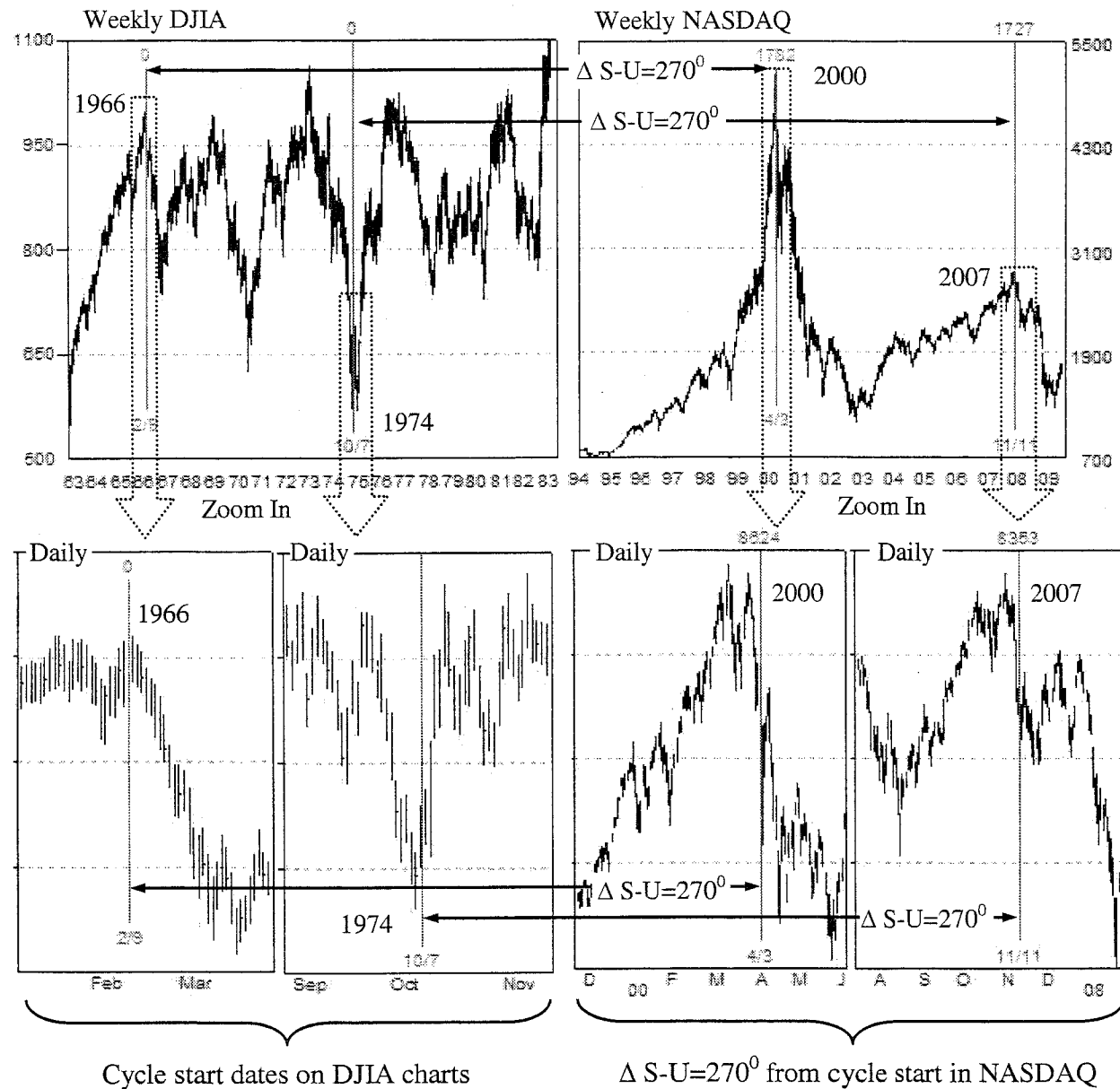
For purpose of comparison the NASDAQ is used after 2000 because the speculative money prefers that market, creating much easier to identify tops and bottoms. The DJIA and S&P tops in 2000 were flat and drawn out making it more difficult to clearly identify the cycle top. The NASDAQ began trading on February 8, 1971 so data prior to that is unavailable. However, after 1971 it is a good market for this type of cyclical analysis, and an excellent trading instrument superior to the outdated DJIA and SP500.

The two charts on the top use weekly data. For a better view of what happened on the important cycle turns there are four daily charts below the weekly that zoom into the turns. This chart shows that the two major tops in 2000 and 2007 aligned very closely with their counterparts in 1966 and 1974 using  $\Delta$  Saturn-Uranus= $270^{\circ}$ .

The 2/9/1966 top occurred after the Saturn-Uranus opposition, at  $178^{\circ} 20'$ . Two complete 17-year cycles later (one down and one up) brought the market back to another top in 2000. The DJIA made a top in January and the NASDAQ made a first top on March 10<sup>th</sup> and a second top on March 24<sup>th</sup>. Adding  $270^{\circ}$  Saturn-Uranus to the 2/9/1966 top gives 4/3/2000, only 5 trading days from the 3/24/2000 top. That is truly amazing accuracy for a slow moving cycle originating 34 years earlier.

The mid-cycle panic low of October 11, 1974 arrived when Saturn-Uranus moved  $72^{\circ}$  from the beginning of the cycle on 2/9/1966. Adding  $270^{\circ}$  Saturn-Uranus to the October 1974 bottom gives the mid-cycle top in November 2007, which was also  $72^{\circ}$  from the March 24, 2000 top.

Again the accuracy of this cycle is amazing, missing the actual top by only 6 trading days, and only 2 trading days from when prices really began to collapse.



Cycle start dates on DJIA charts

$\Delta S-U=270^{\circ}$  from cycle start in NASDAQ

**Chart 7.7**

$\Delta$  Saturn-Uranus= $270^{\circ}$  cycle in DJIA and NASDAQ, 1966-1974 to 2000-2007.



### TIMING THE 1966-1982 CYCLE WITH SATURN-URANUS

*Four-Dimensional Stock Market Structures And Cycles* showed the pattern similarity between 1897-1914 and 1966-1982. These two sections were among those used to measure the sides of a large cubic structure that unfolded in price-time during the complete 1899-1982 Uranus cycle. The cubic structure presented itself when measuring both price and time together. This is a somewhat advanced topic that can be further studied in Sacred Geometry textbooks covering the concept of squaring the circle. This analysis deals with the time circle and the tops and bottoms identified by the pentagonal points around that circle.

All of these market sections will be further studied in the chapters on *Repeating Market Patterns* where it is shown that the timing of these patterns can be forecast without even using planetary cycles. An understanding of pentagonal time relationships predicts the date of their return.

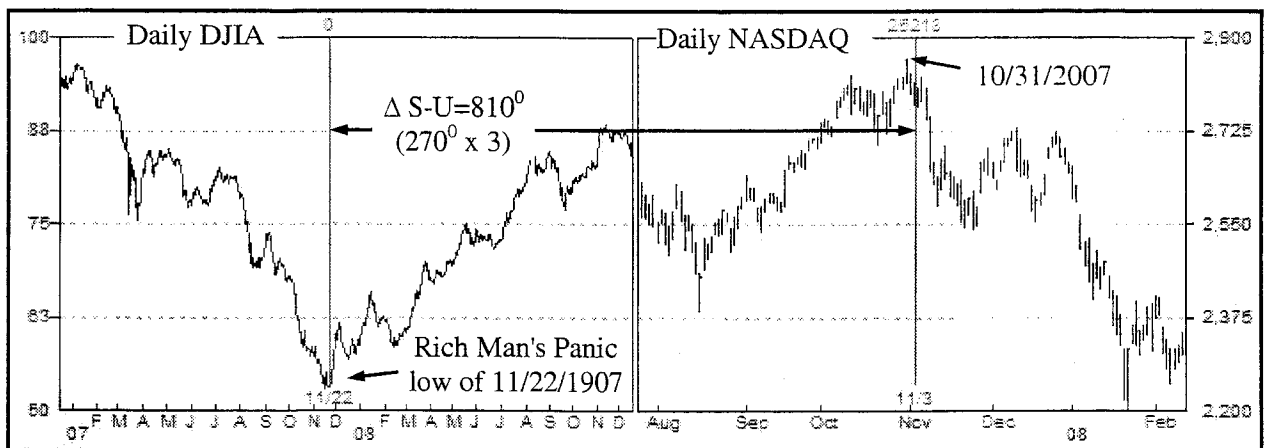
Chart 7.9 shows that measuring the 4<sup>th</sup> multiple of  $\Delta$  Saturn-Uranus= $135^\circ$  back in

time from various turning points in the 1966-1982 cycle produces good alignment with its historical counterpart in 1897-1914. Many points are very close to the  $540^\circ$  movement expected with four  $135^\circ$  cycles ( $4 \times 135^\circ = 540^\circ$ ).

It was previously shown that when Saturn-Uranus moves  $540^\circ$  Uranus moves  $288^\circ$ , completing five points on its pentagram.  $540^\circ$  is the sum of the outer angles of a pentagon ( $108^\circ \times 5$ ).

The 1974 bottom was within 7 minutes of arc of a perfect  $540^\circ$  from the 1907 bottom. The 1973 top aligned very well with the top in 1906, deviating about one degree, and so on.

Chart 7.8 shows that the panic of 2007-2009 started in the NASDAQ on 10/31/2007 when Saturn-Uranus was exactly  $810^\circ$  ( $135^\circ \times 6$ ) from the 1907 "Rich Man's Panic" bottom. It should make the reader pause to think how amazing it is that a cycle measured from 100 years earlier aligned so perfectly with current market conditions. The "horse and buggy" conditions of 100 years ago did not stop the cycle of human



**Chart 7.8**

$\Delta$  Saturn-Uranus= $810^\circ$  from the 1907 "Rich Man's Panic" low to the 2007 NASDAQ top.

behavior from repeating in the high-tech NASDAQ environment of today. Technology changes but people do not. Human behavior repeats today from 100 years ago, and will repeat again 100 years from now.

Again, seeing in a book how these cycles work out does not make the same impression as when the work is done "hands on". To fully grasp these applications the reader needs to explore these cycles with his own charts.

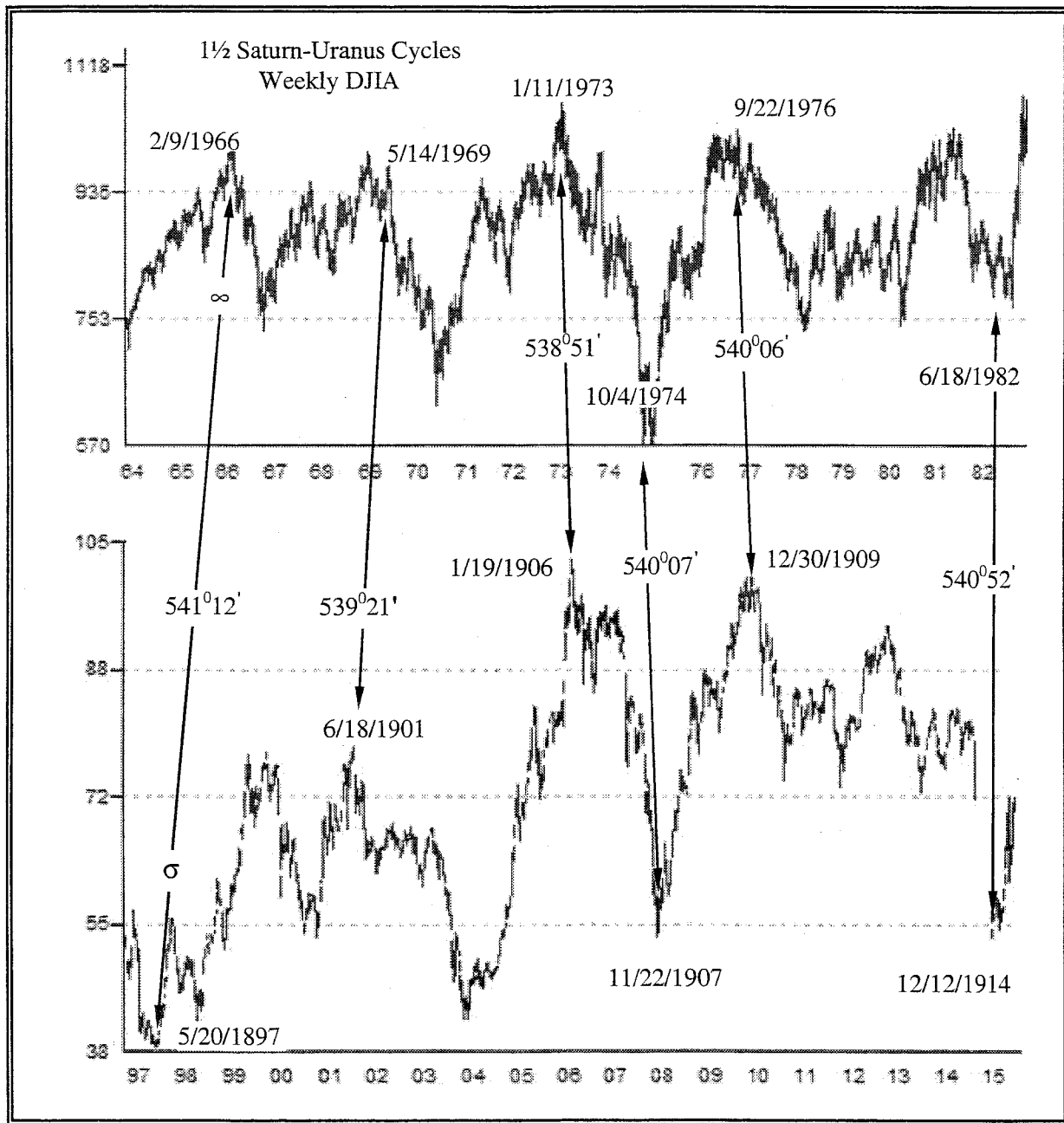


Chart 7.9

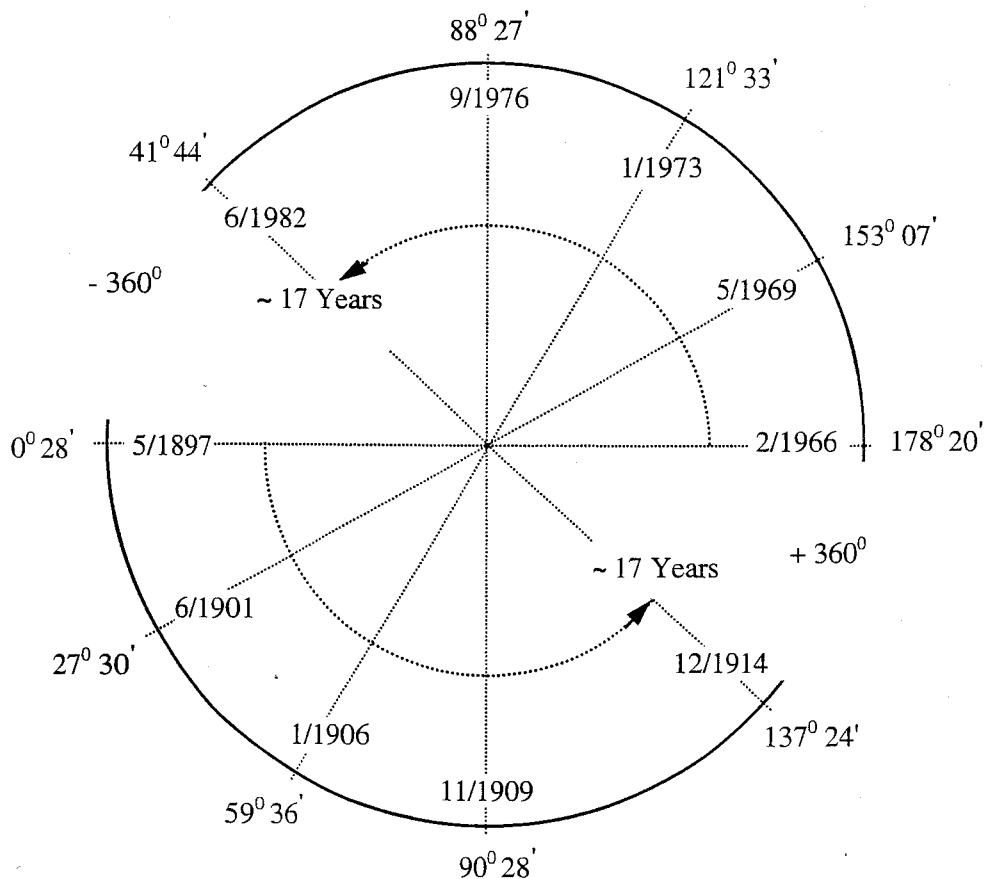
Two 17-year cycles, 67 years apart, and  $\Delta$  Saturn-Uranus =  $540^\circ$  ( $135^\circ \times 4$ ). 1897 was the Saturn-Uranus conjunction ( $\sigma$ ), 1966 was the opposition ( $\infty$ ).

Plotting the 1897-1914 and 1966-1982 sections on a single Saturn-Uranus circle of 45 years gives a better mental image of their symmetry. These  $\sim 135^\circ$  cycles are #1 and #5 from Figure 7.2. The beginning point of the 1897-1914 section is the  $0^\circ$  conjunction on the left side of the circle. Do not confuse this with zero degrees Aries used for sidereal cycles (one planet). The degrees shown on this figure are the angles between the planets and can occur anywhere in the zodiac. The 1897 conjunction ( $0^\circ$ ) occurred at the zodiac location of  $237^\circ$ .

From the 1897 conjunction the circle progressed counter-clockwise to  $137^\circ$  at the reopening in 12/12/1914. The actual duration of this interval was  $136^\circ 56'$  ( $137^\circ 24' - 0^\circ 28' = 136^\circ 56'$ ). When the market

closed in 7/31/1914 the angle was  $133^\circ 52'$ , so there was a  $3^\circ 32'$  movement during the closure. The exact  $135^\circ$  occurred when the market was closed.

The 1966-1982 section is on the opposite side of the circle starting at the  $180^\circ$  opposition and ending when they were about  $42^\circ$  apart. The degrees traveled (displacement) during this section was  $136^\circ 36'$  ( $178^\circ 20' - 41^\circ 44' = 136^\circ 36'$ ), which was very close to the 1897-1914 section, a difference of only  $0^\circ 20'$ . Corresponding sensitive points in these two sections were mirror images of each other, on opposite sides of the circle. Because they were 67 years apart there is an additional  $360^\circ$  circle separating them, or 45 years.



**Figure 7.3**

Mirror images of two 17-year Saturn-Uranus cycles, 1897-1914 and 1966-1982

### **SATURN-URANUS MOVEMENT BETWEEN FOUR 17-YEAR CYCLES**

"Buy and hold" strategies are best during up 17-year cycles, or if the investor holds for less than five years. Many powerful 5-year bull cycles unfold during 17-year down cycles. However, their price gains are always quickly retraced.

Never hold a long position more than five years during a down 17-year cycle. If investors want to buy stocks during down 17-year cycles they need to know what the internals of those cycles have done in the past so they can avoid the devastating bear markets.

Chart 7.10 compares four 17-year cycles since the conjunction of Saturn and Uranus in 1897. To maintain consistency throughout the entire period, the DJIA was used for all four charts. When the reader does his own analysis of the 2000-2017 section he is encouraged to use the NASDAQ because it has a much closer correlation with previous cycles.

The charts each show one complete 17-year cycle and are separated by 34 years. Separating these four cycles are powerful 17-year up trends, such as 1949-1966 and 1983-2000. In fact, almost all of the price appreciation since 1900 has occurred during these two 17-year up cycles. The other 17-year cycles showed no price gain or prices closing lower at the end of 17 years than at the beginning of the cycle. Prices were lower in 1982 than they were in 1966, lower in 1914 than in 1899, and much lower at the 2009 half-point of this down cycle than they were in 2000.

Corresponding  $\sim 135^{\circ}$  movements of Saturn-Uranus during each of these 17-year cycles are shown on the right. They are the odd

cycles 1, 3, 5, 7 from Figure 7.2. Because corresponding points in these cycles are 34 years apart they are separated by  $270^{\circ}$  ( $2 \times 135^{\circ}$ ). Just a few of the major turning points are shown to avoid cluttering. Most of the indicated turns were only a few trading days from the ideal  $270^{\circ}$  interval.

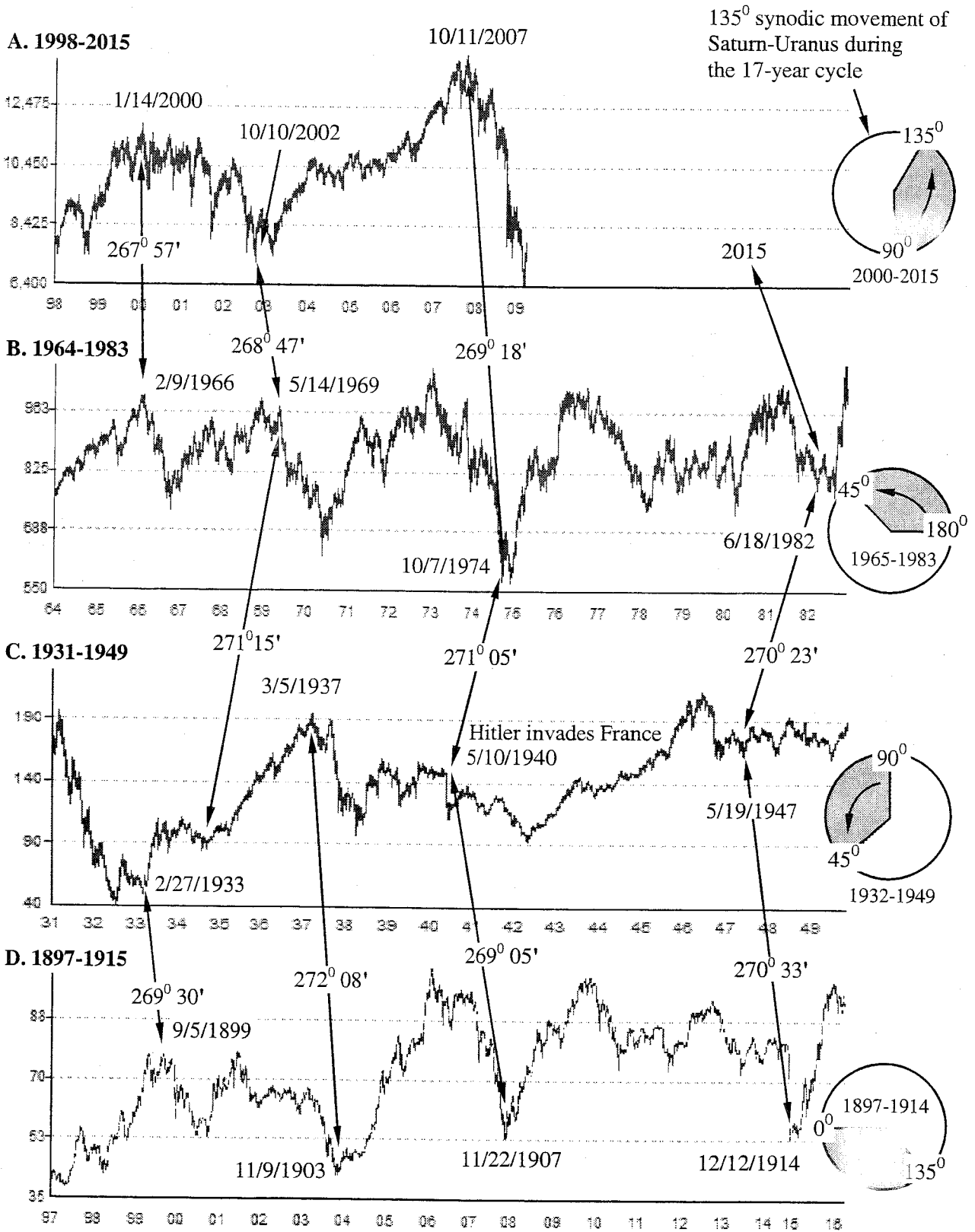
The current cycle shows many close correlations with the  $540^{\circ}$  offset from the 1932-1949 cycle, and  $810^{\circ}$  from the 1897-1914 cycle. One of the more interesting turns to study is the top in 10/11/2007. It is an almost direct hit of  $540^{\circ}$  ( $2 \times 270^{\circ}$ ) from Hitler's invasion of France on 5/10/1940, precipitating that huge market drop.

Looking back one more cycle to  $810^{\circ}$  ( $3 \times 270^{\circ}$ ) is the "Rich Man's Panic" of 1907. The fundamentals underlying the market collapse of 1907 were very similar to the 2008 crash. The speculative fervor of 1907 was Life Insurance and mining stocks. In the 2007 period it was commodities stocks and real estate mortgage insurance also known as credit default swaps. The end result in both periods was a near collapse of the banking and financial systems with many major banks and brokerages failing.

### **REAL-TIME EXAMPLE OF TRADING THE SATURN-URANUS CYCLE**

This is a good point to show an example of how the Saturn-Uranus cycle was publicly used for real-time trading by this author. Four trading hours before the March 6, 2009 bottom this author published on the front page of [www.cycle-trader.com](http://www.cycle-trader.com) that a major bottom had just completed and smart traders should buy. That web page in its original form is shown in Figure 7.4.

One of the tools used to forecast that bottom was simply updating the Saturn-Uranus



**Chart 7.10**

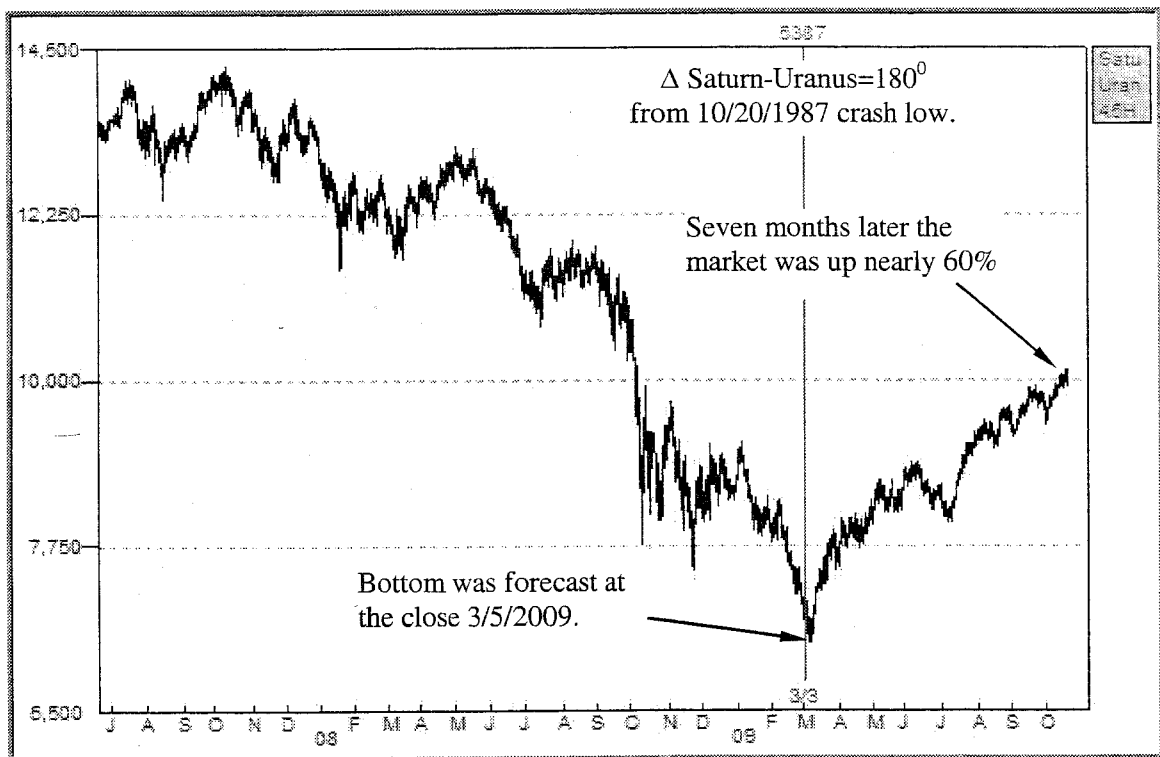
34-year periodicity in the DJIA beginning with the 1897 Saturn-Uranus conjunction. Each chart shows a complete 17-year cycle.

©2009 COWAN

cycle published years earlier in *Four-Dimensional Stock Market Structures and Cycles*, Chart VIII.I. The origin of the  $\Delta$  Saturn-Uranus= $45^0$  cycle was set to the October 20, 1987 crash low. The result hit the 1994 low, the 2000 high, and again at the March 2009 low.

Other cycles also arrived at this time, such as  $\Delta$  Uranus= $144^0$  from the corresponding 1974 mid-cycle low. When the bottom was forecast the market was in a panic and prices were still dropping. Analysts were overwhelmingly bearish and calling for more declines.

Chart 7.11 shows that the morning after the forecast was published after the close on March 5<sup>th</sup> prices briefly dipped for four hours then skyrocketed higher for months moving up faster than they had since the 1930s. When these big cycles turn up they move fast and catch most traders by surprise, as was the case in March 2009.



**Chart 7.11**

March 2009 bottom forecast using the  $\Delta$  Saturn-Uranus= $45^0$  cycle.

**Courses**

Software

Rare Data

About Author

Catalog

Testimonials

Market Calls

Place Order

Contact Us

Links

Home

### STOCK MARKET GEOMETRY

Innovative For The 21st Century - A Visual Approach

Market timing courses, software, and rare long-term data presented by **Bradley F. Cowan**, a successful market trader with 25 years of successful trading experience.

The market modeling techniques taught in this home-study course show how successful traders have predicted the direction of price-time action of STOCK, FOREX, and COMMODITIES markets years into the future.

Through a very unique combination of geometry and cycles, traders can pinpoint turning points in both price and time days or years before they happen.

The workbook like questions and answers show that the results obtained by applying these techniques have an accuracy that does not err by more than one percent! For example, if the techniques indicate a major top 100 trading days in the future the results are not off by more than one trading day.

**Testimonial**

Stock Trading Systems

Recipient of the "READER'S CHOICE AWARDS"

"The readers' choice for the most valuable source!"

Technical Analysis and Commodity

RECENT CYCLE CONDITIONS, ORIGINALLY POSTED 3/3/2009  
STAY TUNED FOR FURTHER UPDATES

It is Cowan's view that the recent plunge in stock market prices should not be seen as a source of fear, rather a rare opportunity to buy quality companies at panic low prices. Investors at these levels will thank their lucky stars.

Many stock market cycle clusters arrive in March. One studied in the course is the slow moving Saturn-Uranus, plotted below with CycleTimer software, moving 180 degrees from the 1987 crash low.

RECENT CYCLE CONDITIONS, ORIGINALLY POSTED 3/3/2009  
STAY TUNED FOR FURTHER UPDATES

It is Cowan's view that the recent plunge in stock market prices should not be seen as a source of fear, rather a rare opportunity to buy quality companies at panic low prices. Investors at these levels will thank their lucky stars.

Many stock market cycle clusters arrive in March. One studied in the course is the slow moving Saturn-Uranus, plotted below with CycleTimer software, moving 180 degrees from the 1987 crash low.

Axis	Planet	Longitude	Date	Hour	Minute	Synodic Angle	Change (Previous)
0	Saturn	261°52'44.401"	10/20/1987	0	0	4°19'17.893"	N/A
1	Uranus	266°12'02.293"					
1	Saturn	333°42'20.685"	3/20/1994	13	57.48	40°40'42.107"	45°00'00.000"

The graph shows the synodic angle of Saturn-Uranus from 1987 to 2009. Key events are marked: 1987 crash, 1994 plunge, and a 180-degree shift in the angle between 1987 and 2009. The current date is 12/30/1983-03/04/2009.

Figure 7.4  
March 5, 2009  
bottom forecast

Figure 7.5 shows the real-time follow-ups of the trade that were posted for several days after the bottom. History shows that in late March the DJIA went up to 8000 and reversed direction for a few days, as forecast below on March 16<sup>th</sup>.

The purpose of showing these posts is to prove that this cycle analysis is more than just an academic exercise and has been proven to have valuable real-time trading applications.

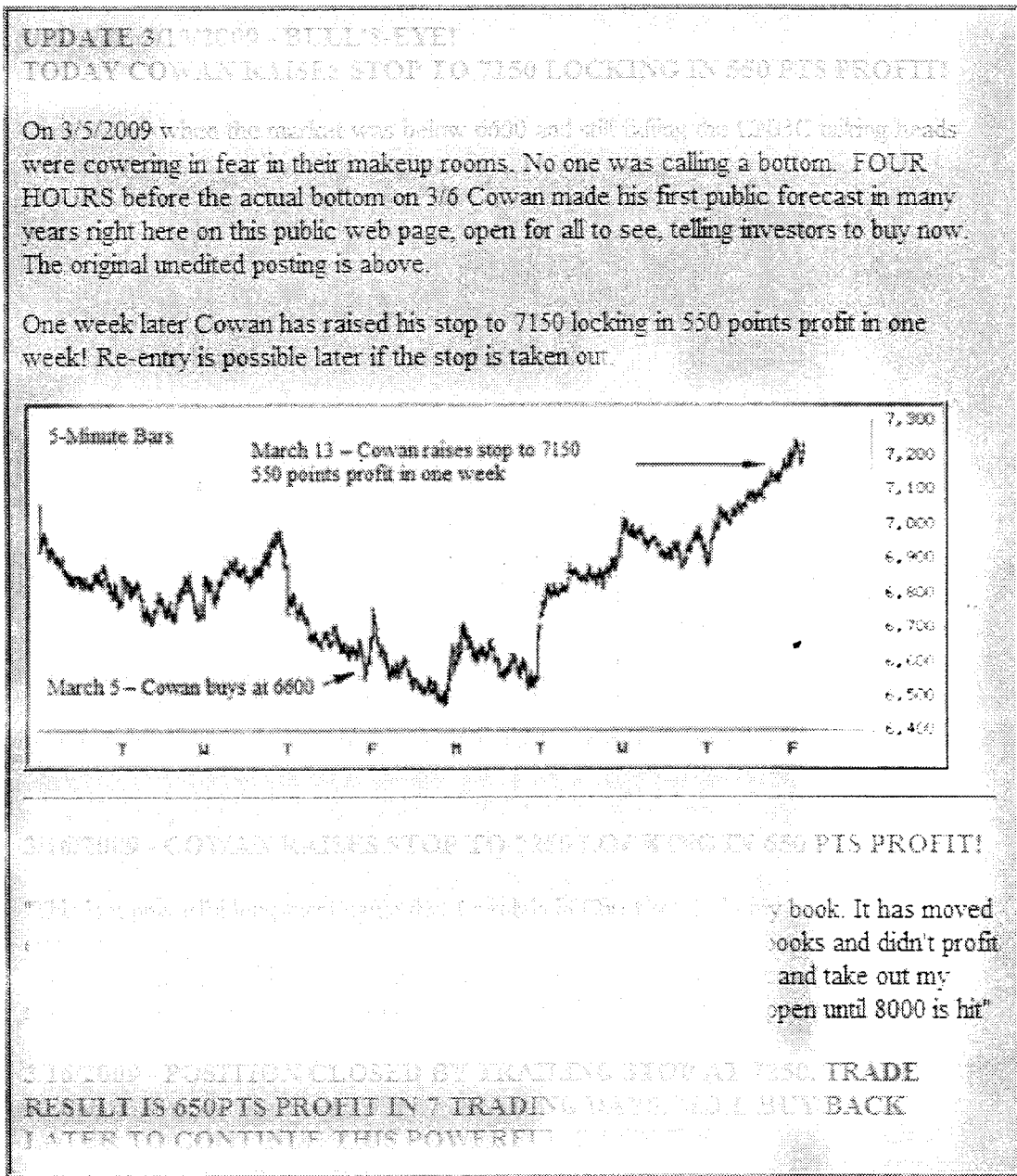


Figure 7.5  
 Real-time website posts following the trades.



**THE SATURN WHEEL**

Figure 7.1 showed that the Saturn-Uranus conjunction clock oscillates back and forth across the zodiac every  $45 \times 2 = 90$  years. Each conjunction is on the opposite side of the zodiac from the previous one. After two conjunctions an additional  $30^\circ$  is added to advance the clock one tick around the zodiac, for a 2-conjunction total of  $\sim 390^\circ$ .

During this 2-conjunction cycle Saturn completes three orbits ( $360^\circ \times 3 = 1,080^\circ$ ) or  $29.4 \times 3 = 88.2$  years. It is this difference between three orbits of Saturn and one 84-year orbit of Uranus that causes the Saturn-Uranus clock to tick one additional  $30^\circ$  at completion.

- 1 Uranus cycle = 84 years
- 2 Saturn-Uranus conjunctions = 90 years
- 3 Saturn cycles ( $1,080^\circ$ ) = 88.2 years

Subdividing these Saturn and Uranus cycles into their  $1/5^{\text{th}}$  harmonics provides a good example of the wheels-within-wheels concept of Ezekiel and ancient astrologers.  $1/5$  of the  $\Delta \text{Saturn}=1,080^\circ$  cycle equals the 17-year  $\Delta \text{Uranus}=72^\circ$  cycle.

$$\frac{1,080^\circ}{5} = 216^\circ \sim 17.6 \text{ years}$$

In other words, Saturn moves  $216^\circ$  five times during one complete 84-year Uranus cycle, or  $\Delta \text{Saturn}=216^\circ \approx \Delta \text{Uranus}=72^\circ$ .

The complete  $1,080^\circ$  Saturn cycle aligns with the Uranus cycle in real-time by overlapping one  $36^\circ$  section.

The total Saturn displacement during one complete 84-year cycle between 1897-1982 was  $1,045^\circ 32'$  to the August 9, 1982 bottom and  $1,043^\circ 46'$  to the first bottom on June 21,

1982. Either way it is very close to  $1,044^\circ = 1,080^\circ - 36^\circ$ .

The 1966-1968 double top is where the Saturn cycle overlapped by  $36^\circ$ . Chart 7.15 shows  $\Delta \text{Saturn}=216^\circ$  from the Uranus  $72^\circ$  axis in 1950 expired in 1968. However, Chart 7.16 shows the new  $\Delta \text{Saturn}=216^\circ$  cycle began running at the Uranus  $72^\circ$  axis in 1966 and expired at the August 1982 bottom. Between 1966 and 1968 Saturn moved  $36^\circ$ .

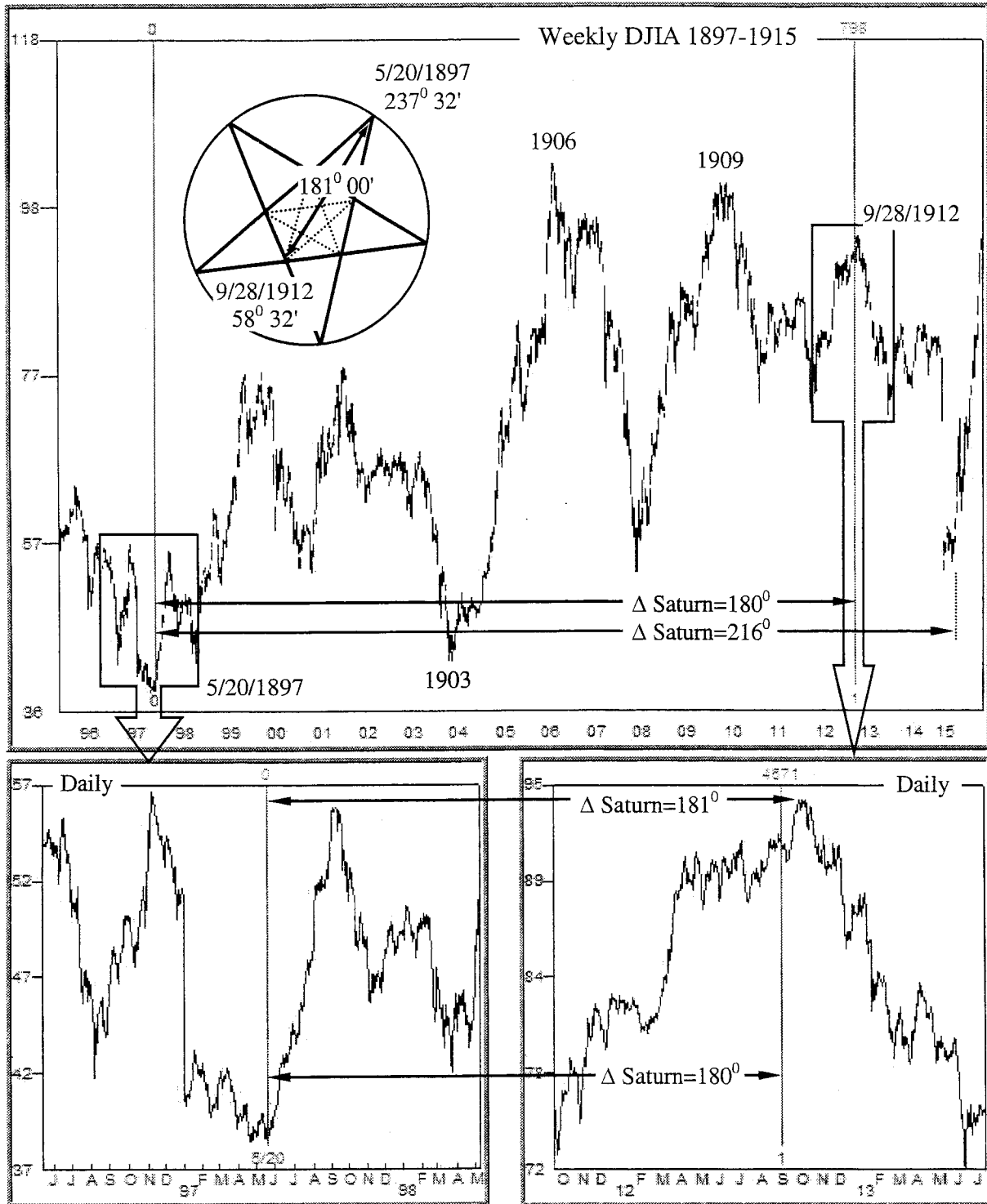
The cause of this overlap is the changing speeds of the planets. Uranus completed an entire  $72^\circ$  cycle between 1950-1966 but Saturn had only moved  $180^\circ$  during that same time. This only happened once during the entire 84-year Uranus cycle and provides the point where the 84-year Uranus cycle aligns with the 88-year Saturn  $1,080^\circ$  cycle. This alignment resulted in an apparent  $36^\circ$  overlap of the two  $216^\circ$  Saturn cycles between the 1966 and 1968 tops.

Armed with knowledge that  $\Delta \text{Saturn}=216^\circ$  aligns with the 17-year  $\Delta \text{Uranus}=72^\circ$  cycle, the same pentagonal timing techniques used to project the Uranus cycle is applied to the faster moving Saturn, greatly narrowing the timing window.

The inner and outer pentagrams of the Uranus cycle were shown to have corresponding sensitive points separated by  $180^\circ$ . Major mid-cycle tops and bottoms occur at  $\Delta \text{Uranus}=180^\circ$  from the start of 17-year cycles. This same principle applies to Saturn where  $\Delta \text{Saturn}=180^\circ$  from the start of 17-year Uranus cycles measures major tops.

The panic of 1912-1915 started when Saturn moved  $180^\circ$  from the same 5/20/1897 bottom used for the Uranus and Saturn-Uranus cycles. The complete 17-year cycle

lasted  $216^\circ$  to the bottom in 1915, aligning closely with the  $\Delta$  Uranus= $72^\circ$  cycle from the 1897 bottom.



**Chart 7.12**  
 $\Delta$  Saturn= $180^\circ$  from the 1897 Uranus= $72^\circ$  cycle bottom is the 1912 top and 3-year decline.

The crash of 1929 started when Saturn moved 180° from the 1915 bottom. The arrival of the cycle on 10/31/1929 was only two days after the October 29<sup>th</sup> crash. The following 3-year panic lasted into the 1932-

1933 double bottom where  $\Delta$  Saturn=216° and  $\Delta$  Uranus=72° from the 1915 bottom. This culmination of the 17-year cycle with a 3-year bear market is the same pattern seen in the 1897-1915 cycle.

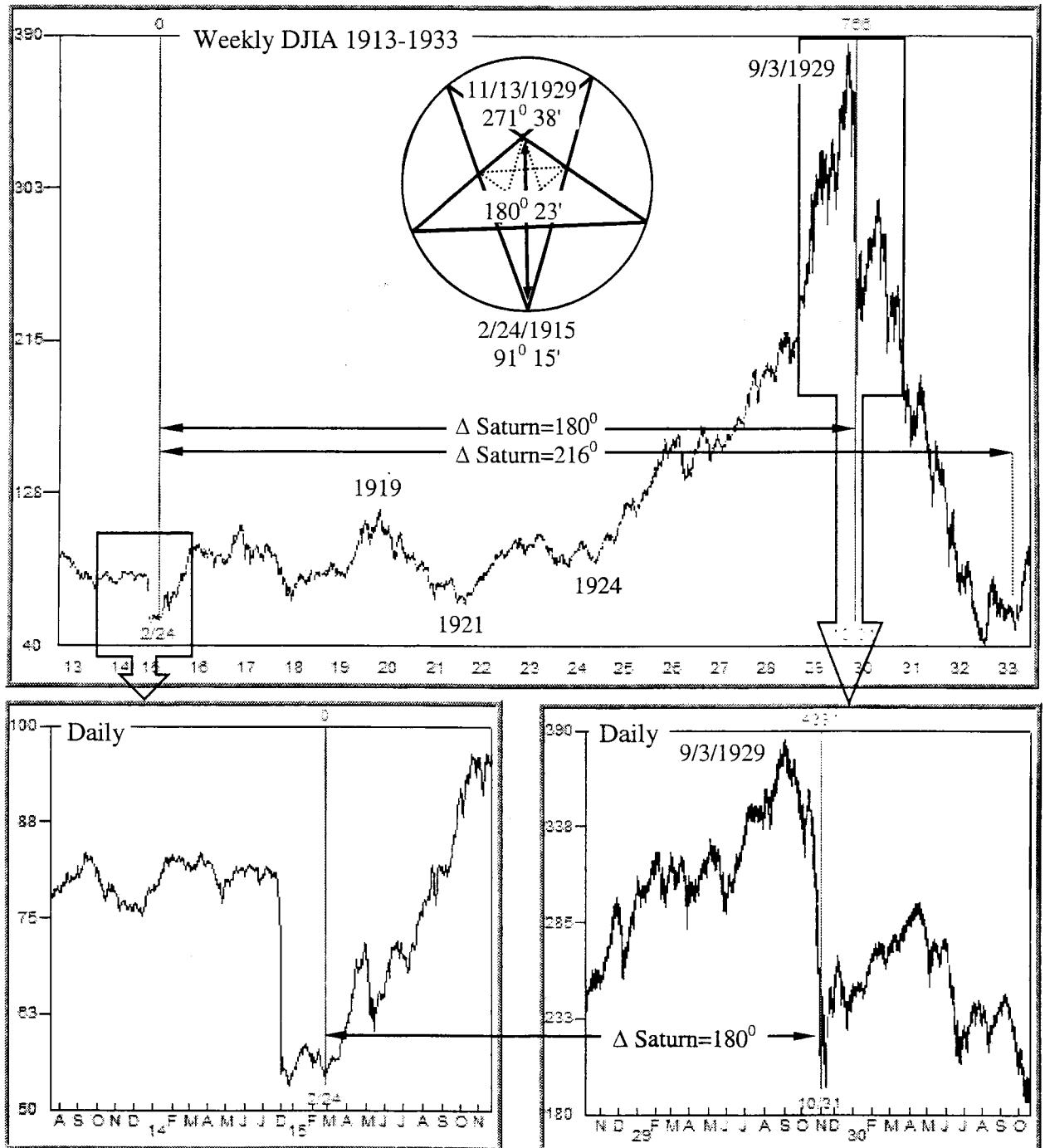


Chart 7.13

$\Delta$  Saturn=180° from the 1915 bottom is the 1929 crash and 3-year decline.

Following the same technique,  $\Delta$  Saturn= $180^{\circ}$  is measured from the Uranus= $72^{\circ}$  axis at the 7/8/1932 bottom. Again, the cycle arrived at another panic in

1946 followed by another 3-year decline into the 1949 bottom, similar to 1912-1915 and 1929-1932. Again, 1949 measured  $\Delta$  Saturn= $216^{\circ}$  from 1932.

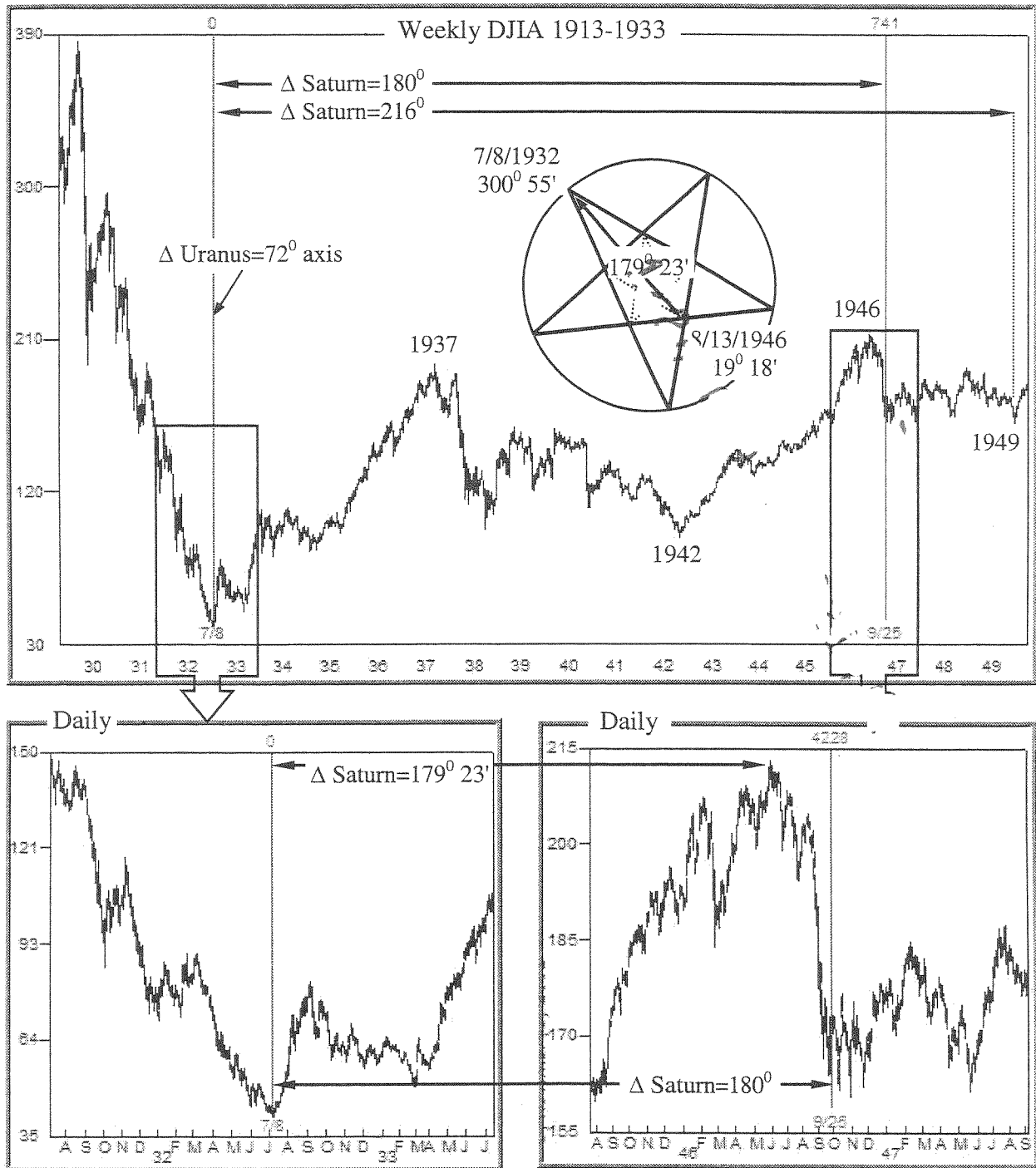


Chart 7.14

$\Delta$  Saturn= $180^{\circ}$  from the 1932 Uranus= $72^{\circ}$  cycle is the 1946 panic and 3-year bear market.

One year after the 1949  $\Delta$  Saturn=216<sup>0</sup> bottom, Uranus arrived at its 72<sup>0</sup> axis, ushering in the Korean War in 6/1950. Wheels-within-wheels aligns the start of the next Saturn cycle with the larger 72<sup>0</sup> Uranus cycle in 1950. As in the past,  $\Delta$  Saturn=180<sup>0</sup> terminated the advance at the top in 2/1966, which is also the  $\Delta$  Uranus=72<sup>0</sup> from 1950.

The market did not drop for 3-years into the  $\Delta$  Saturn=216<sup>0</sup> cycle low as in the past because even though the  $\Delta$  Saturn=216<sup>0</sup> cycle did not complete until 1968, the new Saturn cycle began at the Uranus axis in 1966, following the wheels-within-wheels concept.

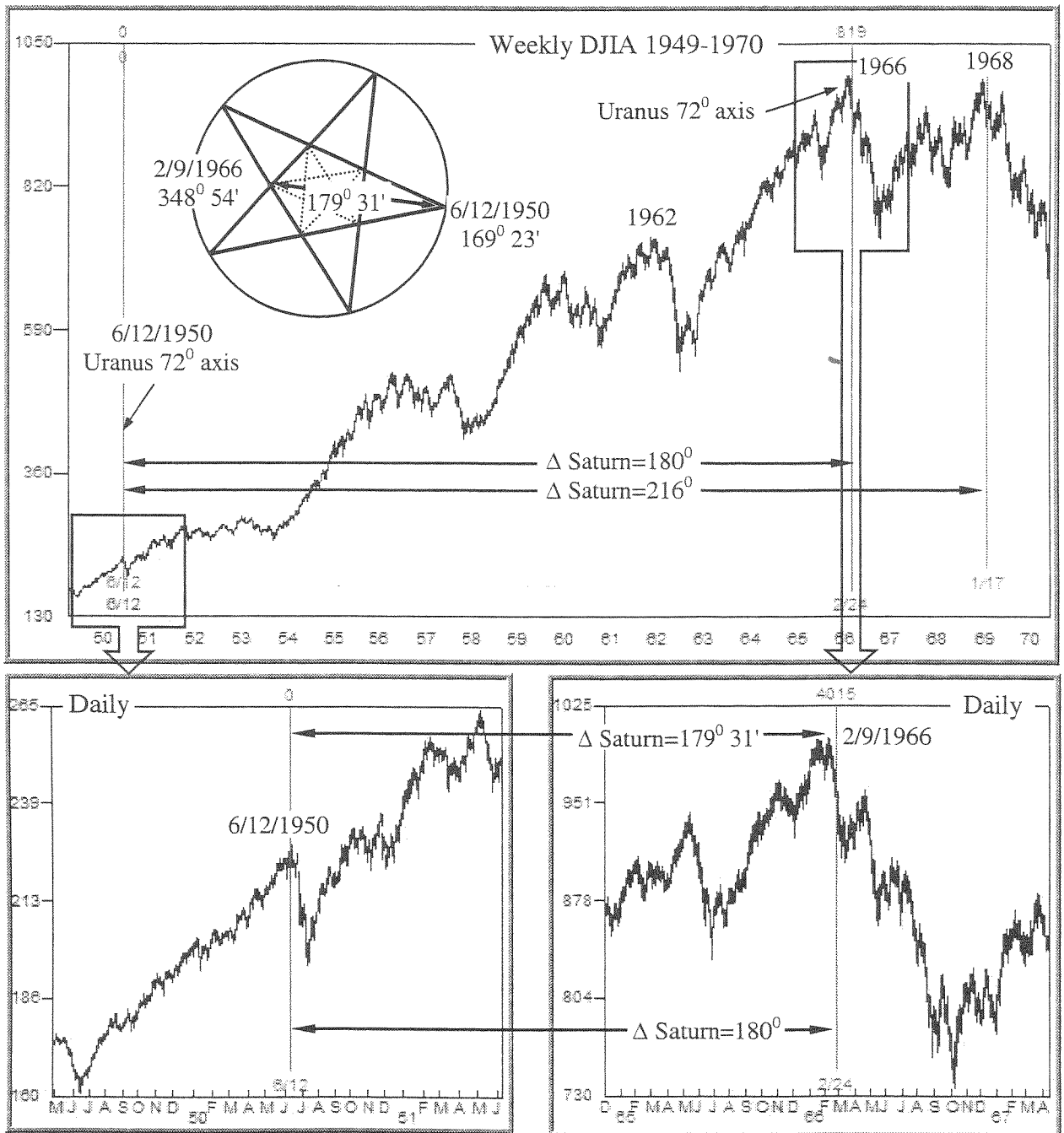


Chart 7.15

$\Delta$  Saturn=180<sup>0</sup> from the 1950 Uranus=72<sup>0</sup> cycle is the 1966 top at the S-U opposition.

The  $\Delta$  Saturn= $216^{\circ}$  cycle from 1950 continued to run until 1968, another major top, especially in the SP500. This explains the 1966-1968 overlap of the two  $\Delta$  Saturn= $216^{\circ}$  cycles, 1950-1968 and 1966-1982.

The major 17-year cycle top in 1966 was the first time since 1897 that the  $\Delta$  Uranus= $72^{\circ}$  cycle arrived before the  $\Delta$  Saturn= $216^{\circ}$

cycle, in 1968. This provides additional evidence that the  $\Delta$  Saturn= $216^{\circ}$  cycle aligns with the larger Uranus cycle:  $\Delta$  Saturn= $180^{\circ}$  from the 1966 top was the top in 1980, followed by the typical 3-year decline into the bottom in late 1982, ending the 17-year cycle. The complete 17-year cycle from the Uranus cycle top in 1966 to 1982 was again  $\Delta$  Saturn= $216^{\circ}$ .

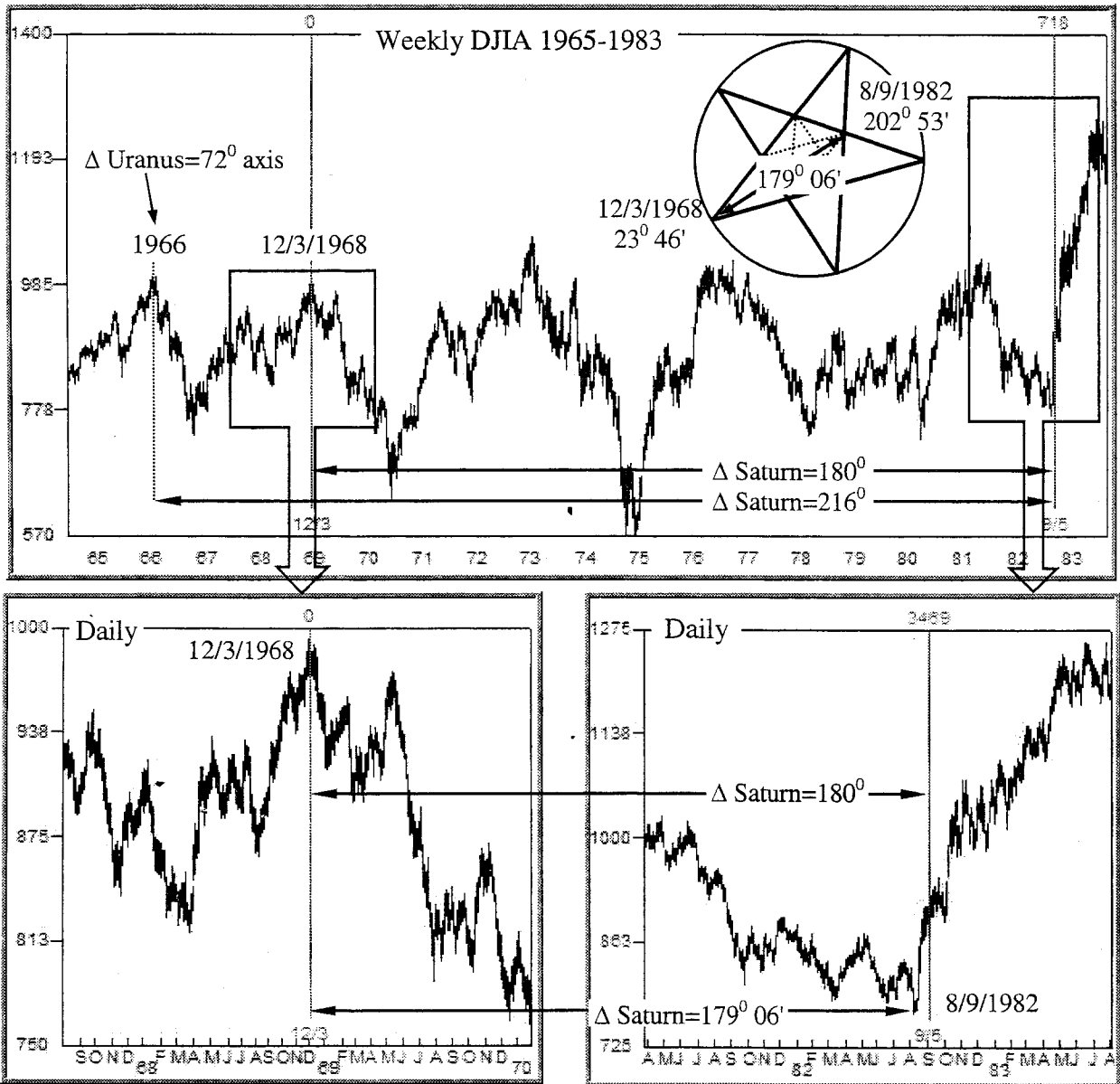


Chart 7.16

$\Delta$  Saturn= $180^{\circ}$  from the 1968 top is the 1982 17-year bottom.

In 6/1981 the new  $\Delta$  Saturn= $216^{\circ}$  cycle again aligned with  $\Delta$  Uranus= $72^{\circ}$ .  $\Delta$  Saturn= $216^{\circ}$  from the 1981 Uranus cycle arrived within a few days of the 17-year cycle "dot com" top in January 2000, providing additional proof of the wheels-within-wheels concept of Saturn and Uranus pentagonal cycles.

The sharp drop from 1981-1982 was caused by Uranus arriving at its 6/1981 cycle before Saturn completed its  $216^{\circ}$  cycle in 1982.

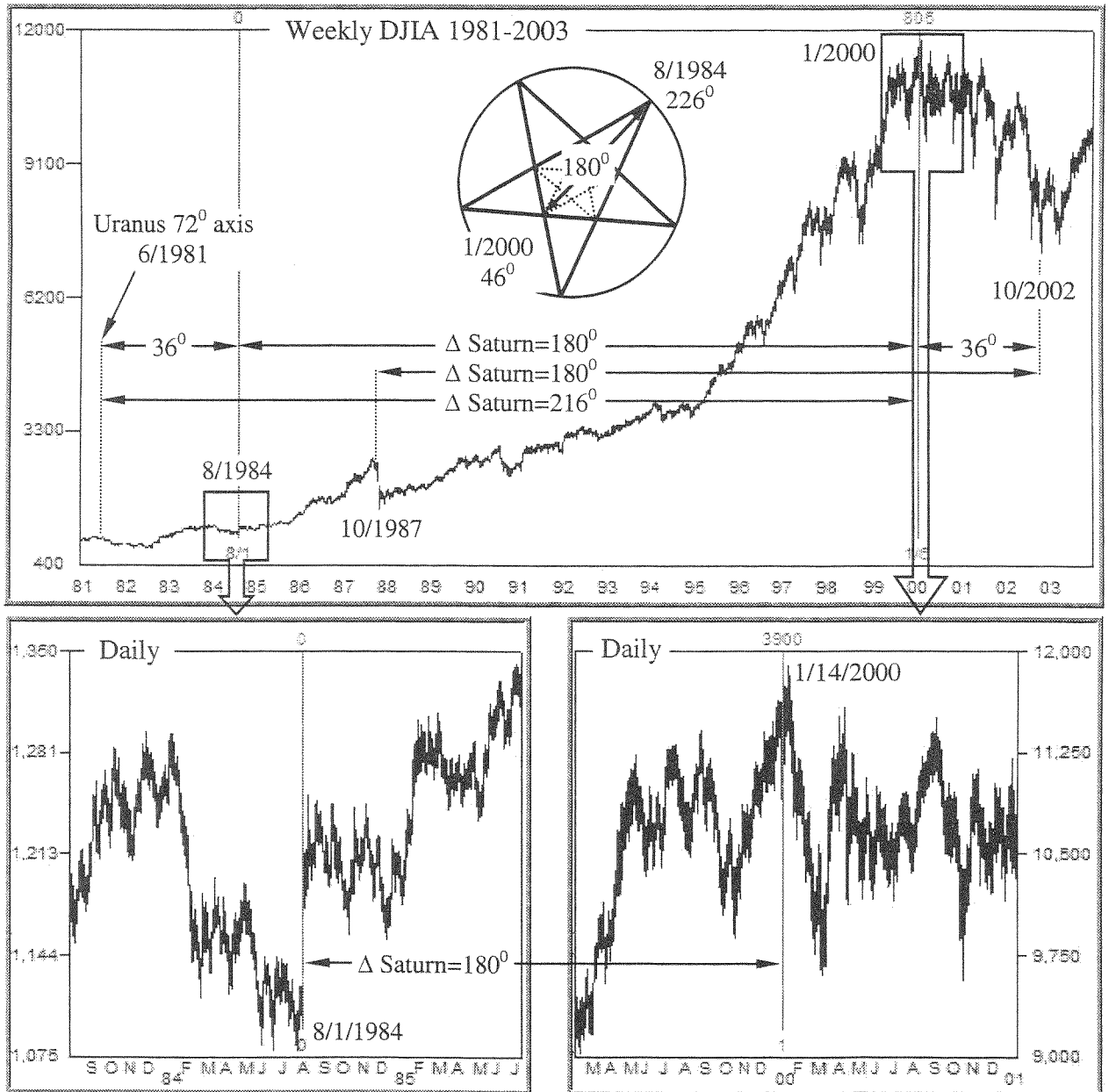


Chart 7.17

$\Delta$  Saturn= $216^{\circ}$  from the 1981 Uranus= $72^{\circ}$  cycle is the 2000 top and 3-year decline.

The top in 1998 was on the opposite side of the pentagram from the 8/1982 bottom, both points are also on the Uranus inner and outer pentagrams from Figure 4.1.

Prices dropped sharply when Saturn arrived at the pentagram, and continued down until 9/1/1998 when Uranus arrived at the pentagram at  $311^{\circ}$ , a full  $360^{\circ}$  from 1914.

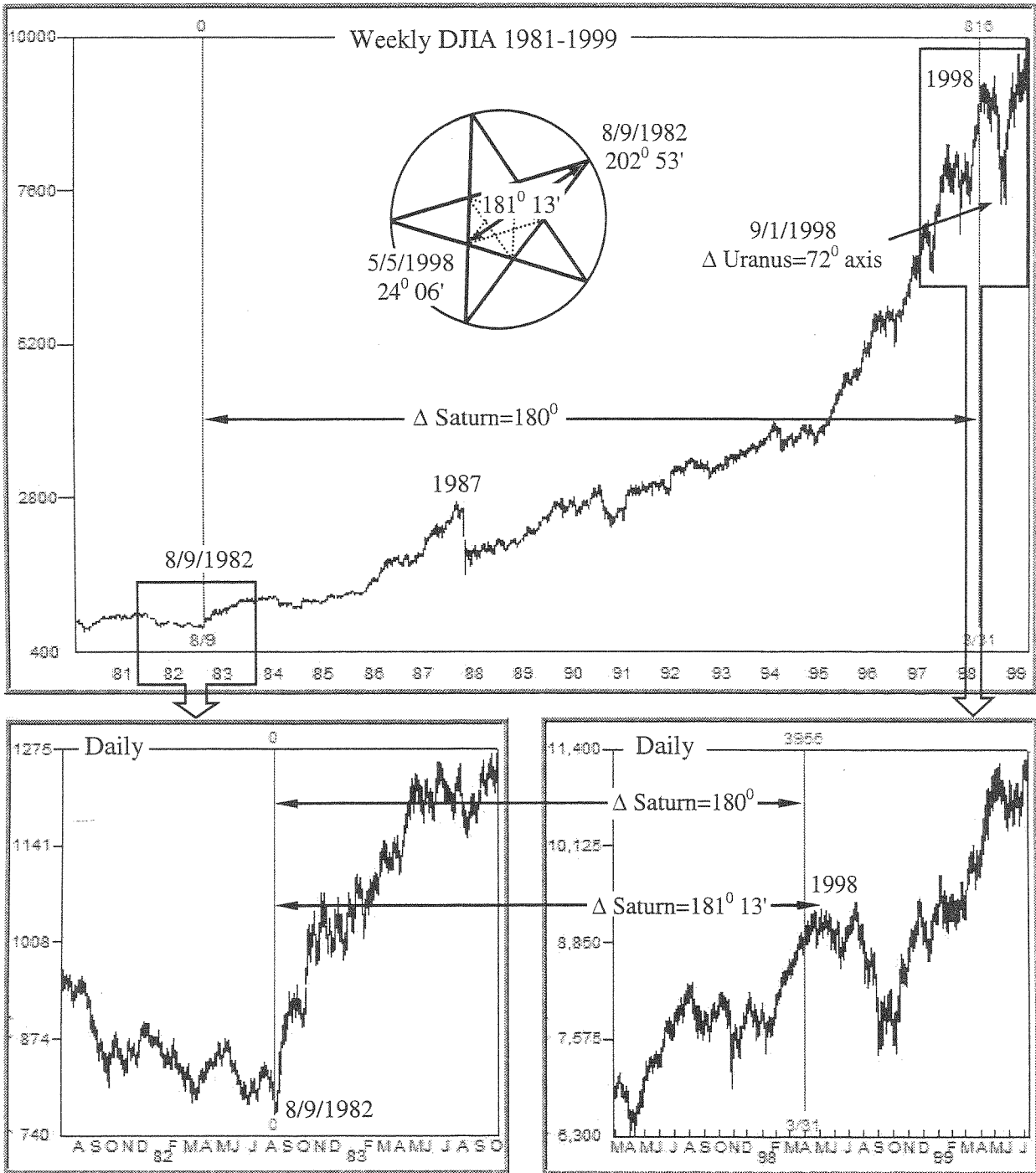


Chart 7.18

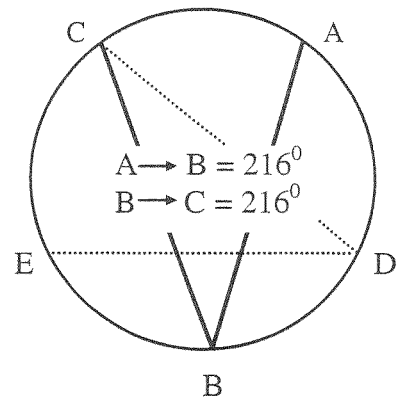
Δ Saturn = 180° from the 1982 bottom is the 1998 top and 20% decline.



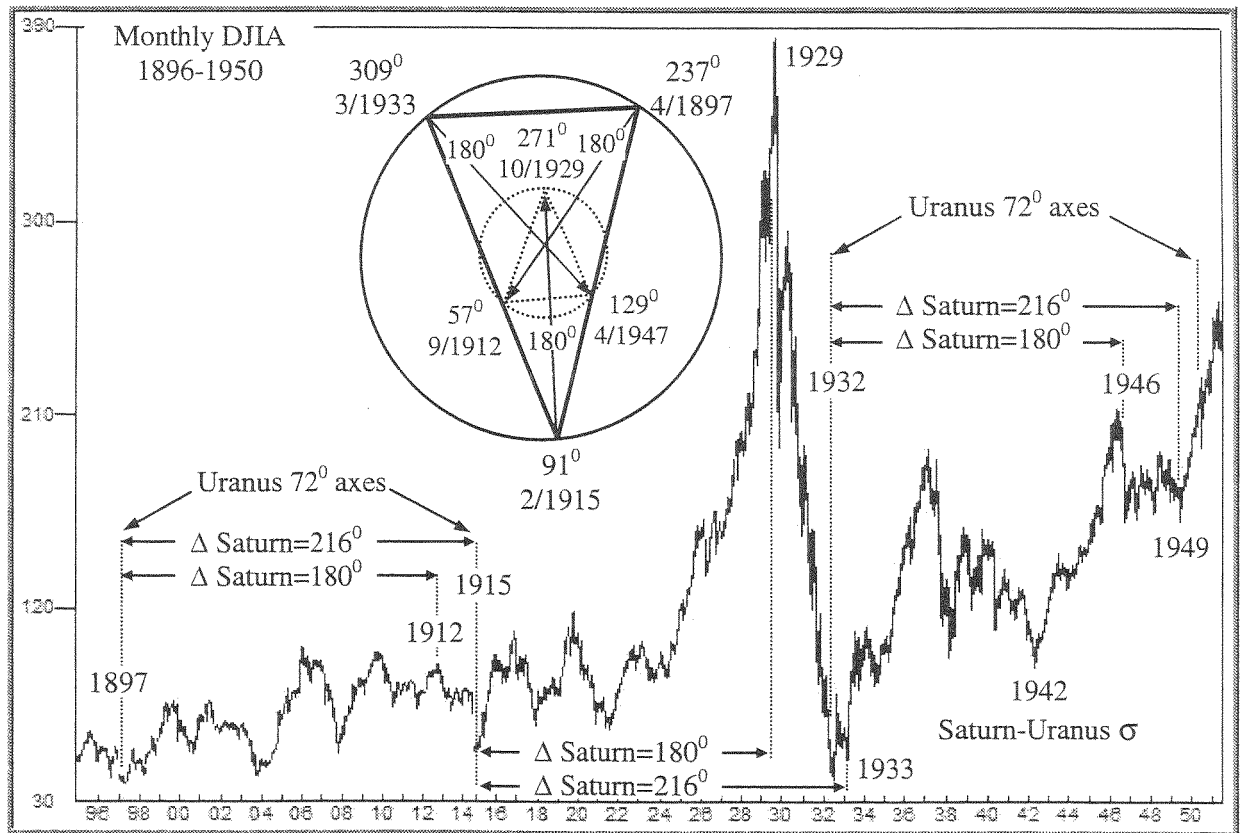
**THE SATURN GOLDEN TRIANGLE**

Rotating  $216^{\circ}$  twice fixes three points on a Golden Triangle, A to B to C. If this process is repeated, C to D to E, another Golden Triangle is formed fixing all five points of a pentagram.

Chart 7.19 shows the  $\Delta$  Saturn= $216^{\circ}$  cycle rotating around the zodiac between the 1897-1915-1932 bottoms. These three bottoms defined a Golden Triangle on the same zodiac points as the  $\Delta$  Uranus= $72^{\circ}$  17-year pentagram from Figure 4.1.



**Figure 7.6**  
Two  $216^{\circ}$  rotations form a Golden Triangle



**Chart 7.19**  
Saturn Golden Triangle formed by  $\Delta$  Saturn= $216^{\circ}$  in the DJIA 1897-1933.

Uranus defined one side of a Golden Triangle when it moved  $144^{\circ}$  from 1897 to 1932. During this same time Saturn moved  $216^{\circ} \times 2$ , defining a complete Golden Triangle.

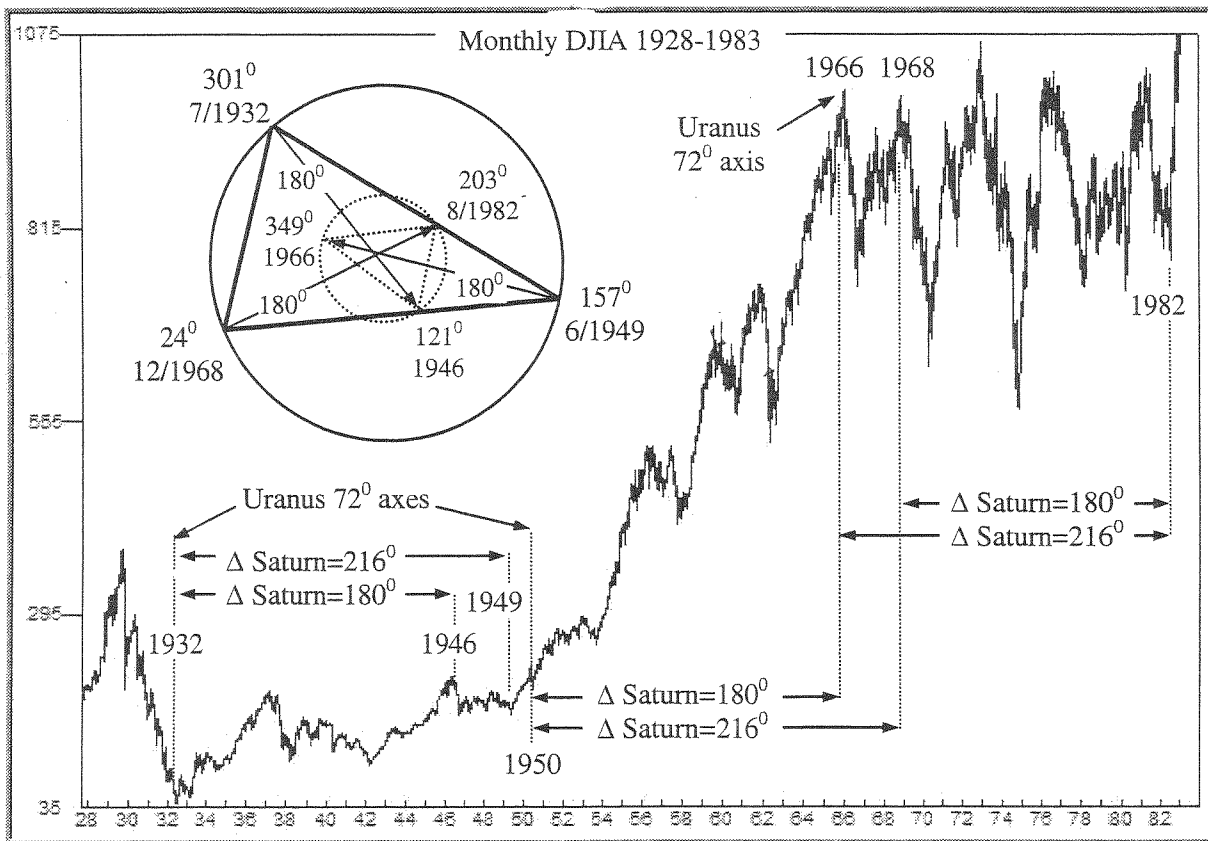
Beginning at the 1932 Uranus  $72^{\circ}$  axis, another Saturn Golden Triangle was formed by the  $\Delta$  Saturn= $216^{\circ}$  cycle rotating around the zodiac twice between 1932-1949-1968. During this time Uranus completed one side of its Golden Triangle by moving  $144^{\circ}$ , 1932-1950-1966, completing its Golden Triangle from 1897 ( $288^{\circ}$  total).

This chart illustrates two examples where the start of the Saturn cycle aligned with the larger Uranus cycle. Having three 17-year cycles on the same chart makes this concept

clearer. The  $\Delta$  Saturn= $216^{\circ}$  cycle began in 1950 not where it ended in 1949.

An even clearer example is the 1966-1968 double top.  $\Delta$  Saturn= $216^{\circ}$  began running at the Uranus cycle in 1966. It again measured  $216^{\circ}$  to 1982. This clearly shows the  $36^{\circ}$  Saturn cycle overlap 1966-1968 caused by alignment with Uranus  $72^{\circ}$  in 1966.

All these points are the same as on the Uranus pentagram studied earlier. Later chapters will show that at major turning points such as 1897, 1915, and 1932 there is a cluster of planets on the Great Pentagram, not just Saturn and Uranus.



**Chart 7.20**  
Saturn Golden Triangle formed by  $\Delta$  Saturn= $216^{\circ}$ , 1932-1968.

**THE SATURN PENTAGRAM 1897-1982**

Overlaying the two Saturn Golden Triangles from Charts 7.17 and 7.18 forms the same Uranus pentagram studied earlier. The dates and locations on this Saturn pentagram should be compared with the Uranus pentagram of Figure 4.1.

The stock market wheels-within-wheels takes the form of the Saturn pentagram rotating within the Uranus pentagram. The dates on Figure 7.7 include three complete Saturn  $360^\circ$  cycles and one complete Uranus cycle originating at the 1897 Saturn-Uranus conjunction.

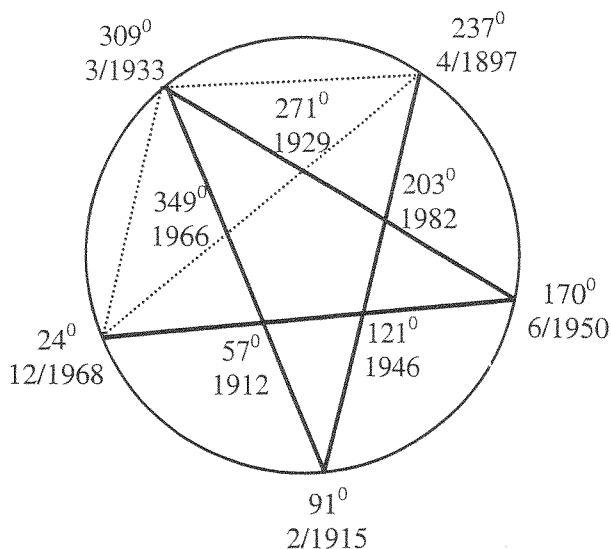
**SATURN  $36^\circ$  HARMONICS**

The smaller harmonics of the Uranus cycle down to  $18^\circ$  have been shown to correlate closely with market cycles. Saturn harmonics show the same reliable timing when measured from the larger Uranus pentagonal axes.

Chart 7.21 shows that each of the  $\Delta$  Saturn= $36^\circ$  cycles starting at the Saturn-Uranus conjunction in 1897 aligned with major turning points. Again, these cycle points are the same as the Uranus pentagram studied earlier.

Chart 7.22 shows the wheels-within-wheels Saturn cycles aligned with the 1981 Uranus axis. Every  $\Delta$  Saturn= $36^\circ$  cycle after the 1981 axis hit a major turning point.

$\Delta$  Saturn= $216^\circ$  from 6/25/1981 arrived at the 17-year cycle "dot com" top in January 2000. The next  $\Delta$  Saturn= $36^\circ$  was the end of the "dot com" bust at the 2003 bottom, measuring  $180^\circ$  Saturn from the crash of 1987.

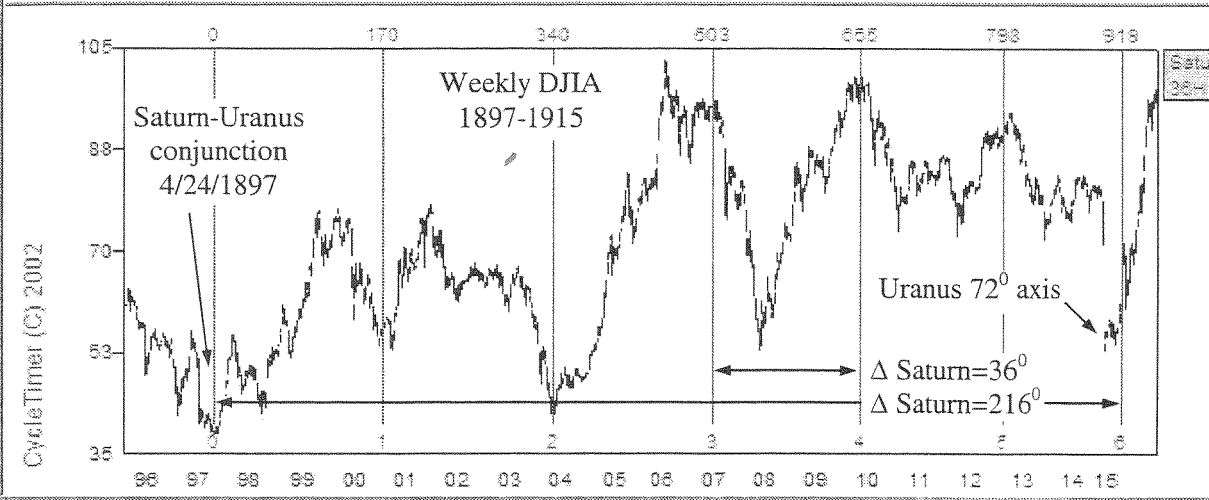
**Figure 7.7**

Two Saturn Golden Triangles 1897-1968

In 2007 the  $\Delta$  Saturn= $36^\circ$  cycle aligned with the Uranus mid-cycle panic top measured  $180^\circ$  from the 1966 top.

The reader should now begin to see how the Saturn and Uranus cycles align with each other at major turning points such as 2007.

Axis	Planet	Longitude	Date	Hour	Minute	Change	Change (From Start)
0	Saturn	236°44'54.710"	4/24/1897	17	21.9	N/A	N/A
1	Saturn	272°44'54.710"	7/27/1900	4	55.8	36°00'00.000"	36°00'00.000"
2	Saturn	308°44'54.710"	10/28/1903	5	0.06	36°00'00.000"	72°00'00.000"
3	Saturn	344°44'54.710"	12/9/1906	23	32.65	36°00'00.000"	108°00'00.000"
4	Saturn	20°44'54.710"	11/11/1909	5	6.91	36°00'00.000"	144°00'00.000"
5	Saturn	56°44'54.710"	8/10/1912	10	51.21	36°00'00.000"	180°00'00.000"
6	Saturn	92°44'54.710"	4/5/1915	0	35.41	36°00'00.000"	216°00'00.000"



Axis	Planet	Longitude	Date	Hour	Minute	Change	Change (From Start)
0	Saturn	91°12'47.867"	2/23/1915	0	0	N/A	N/A
1	Saturn	127°12'47.867"	10/17/1917	20	25.85	36°00'00.000"	36°00'00.000"
2	Saturn	163°12'47.867"	7/18/1920	3	13.2	36°00'00.000"	72°00'00.000"
3	Saturn	199°12'47.867"	6/21/1923	6	22.94	36°00'00.000"	108°00'00.000"
4	Saturn	235°12'47.867"	8/1/1926	5	30.23	36°00'00.000"	144°00'00.000"
5	Saturn	271°12'47.867"	10/29/1929	18	18.74	36°00'00.000"	180°00'00.000"
6	Saturn	307°12'47.867"	1/29/1933	12	49.17	36°00'00.000"	216°00'00.000"

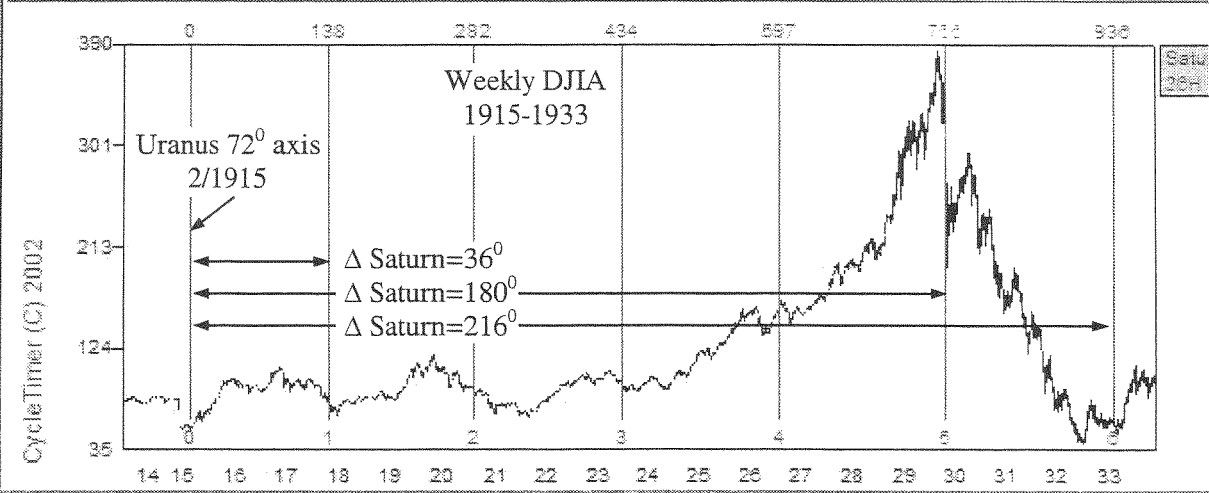
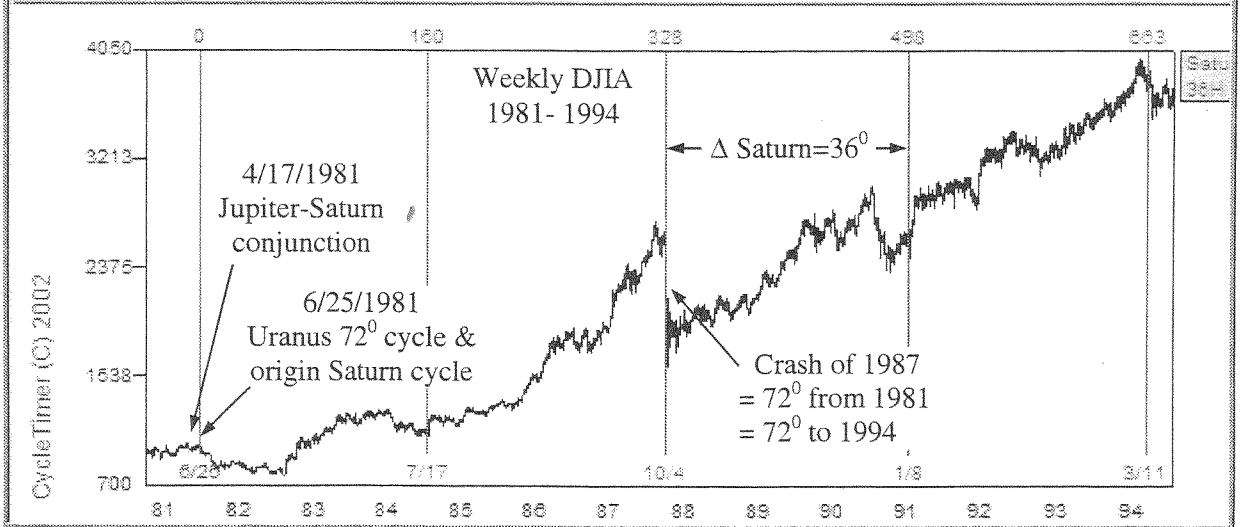


Chart 7.21

Δ Saturn = 36° measured from the 4/25/1897 conjunction.

Axis	Planet	Longitude	Date	Hour	Minute	Change	Change (From Start)
0	Saturn	189°25'21.502"	6/25/1981	0	0	N/A	N/A
1	Saturn	225°25'21.502"	7/17/1984	4	11.04	36°00'00.000"	36°00'00.000"
2	Saturn	261°25'21.502"	10/4/1987	21	12.23	36°00'00.000"	72°00'00.000"
3	Saturn	297°25'21.502"	1/8/1991	18	45.47	36°00'00.000"	108°00'00.000"
4	Saturn	333°25'21.502"	3/11/1994	17	8.31	36°00'00.000"	144°00'00.000"



Axis	Planet	Longitude	Date	Hour	Minute	Change	Change (From Start)
4	Saturn	333°25'21.502"	3/11/1994	17	8.31	36°00'00.000"	144°00'00.000"
5	Saturn	9°25'21.502"	3/6/1997	13	36.8	36°00'00.000"	180°00'00.000"
6	Saturn	45°25'21.502"	12/24/1999	9	5.54	36°00'00.000"	216°00'00.000"
7	Saturn	81°25'21.502"	8/27/2002	22	11.6	36°00'00.000"	252°00'00.000"
8	Saturn	117°25'21.502"	4/19/2005	17	27.23	36°00'00.000"	288°00'00.000"
9	Saturn	153°25'21.502"	1/6/2008	10	8	36°00'00.000"	324°00'00.000"

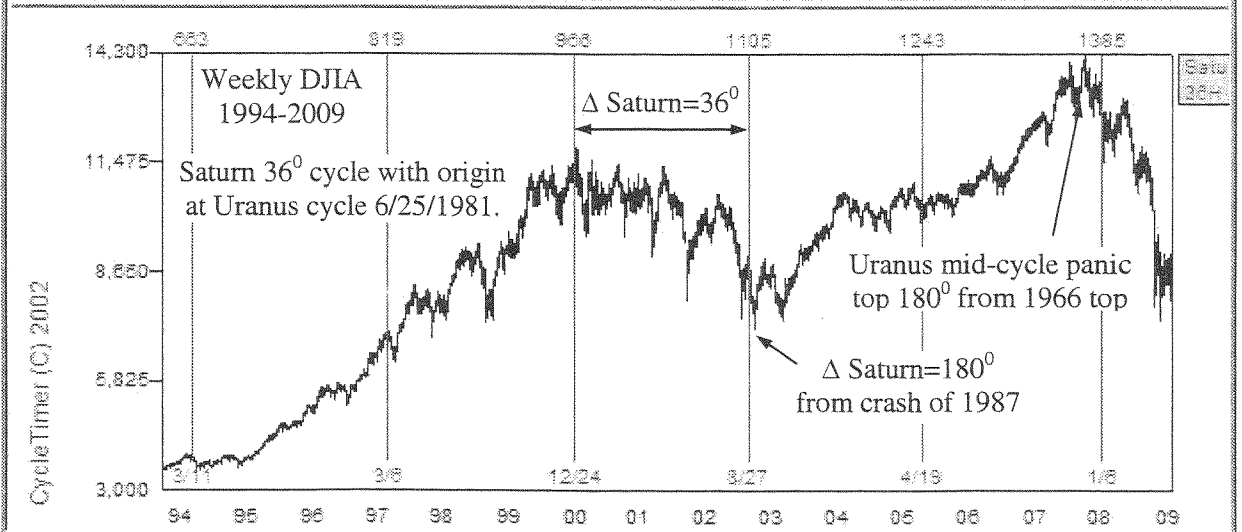


Chart 7.22

Δ Saturn = 36° measured from the Uranus 72° axis in 6/25/1981.

*Twelve years they served Chedorlaomer,  
and in the thirteenth year they rebelled. ...Genesis 14:4*

The planets in our solar system move like a beautifully orchestrated clock with awe-inspiring perfection challenging and enticing us to discover their hidden secrets. Becoming aware of even a small part of the great balance and order of the cosmos forever changes a person's outlook on the world around him and his place within it. It is a very humbling experience to say the least to learn how small man is within this well-structured and organized universe.

Most readers of this material are familiar with the Fibonacci numbers including 2, 3, 5, 8, and 13. The question is how does the pentagram tie together Fibonacci, the Square of Twelve, planetary motion, and the pool of mass human psychology measured by stock market cycles?

This analysis will now study the cycles smaller than 17 years, starting with the 13-year cycle. Correlation with the slower moving outer planets, Uranus and Jupiter, will be shown, then connected with the faster moving inner planets, Earth and Venus. Showing the connection between stock market cycles and both the outer and inner planets provides observational proof supporting the wheels-within-wheels theory of financial astro cycles.

Pentagonal spatial geometry will be used to correlate the 13-year cycle with the dynamics of Venus, Earth, and the 17-year cycle. This pentagonal geometry will then

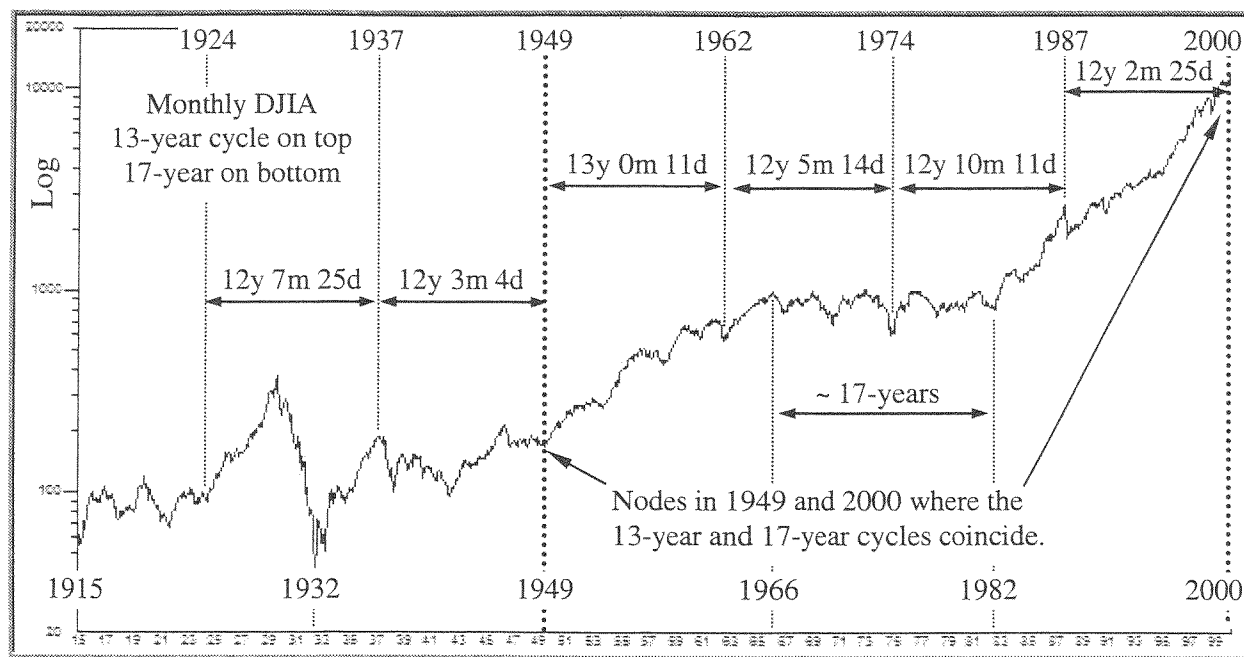
be used to isolate the 8 and 5-year cycles. The analyst will learn how to project into the future expected recurrence dates for these cycles, and how to calculate the expected duration of these cycles once underway.

Later chapters will add Mars and Ceres, but adding too many cycles at once would be too much to grasp. Ceres is the best representative of the asteroid belt between Mars and Jupiter. A simple mathematical equation will be derived and reduced to a pentagonal number series connecting Venus, Earth, Mars, and Ceres to the 13-year cycle.

### **THE 13-YEAR CYCLE**

Chart 8.1 shows that the 13-year cycle is one of the easiest to identify on a long-term chart. Six recurrences of this cycle are identified with dotted lines above the graph using monthly DJIA from 1915 to 2000. For reference the 17-year cycle is also shown below the graph.

The 13-year cycle has not missed a beat since before the "Roaring 20's" and the Great Depression of the 1930s. It has coincided with some of the most brutal bear markets and panics, 1962, 1974, the crash of 1987, and the 'dot com' crash of 2000. Prior to 1962 this cycle marked the 1949 bottom, the end of the 5-year rally in 1937, and the 1924 beginning of the 5-year rally in the 'Roaring 20s'. Chart 8.2 expands each cycle using weekly data for a closer view.



**Chart 8.1**

13-year and 17-year cycles in monthly DJIA, 1915-2000.

One key point to notice on Chart 8.1 is that the 13-year and 17-year cycles come together at nodal points in 1949 and 2000. 1897 was the nodal point prior to 1949. This is the 50-year "Period of Jubilee" in the Bible and referenced by W.D. Gann<sup>23</sup>.

Leviticus 25:8 "And thou shalt number seven Sabbaths of years unto thee, seven times seven years; and the space of seven Sabbaths of years shall be unto thee forty and nine years."

25:11 "A jubilee shall that fiftieth year be unto you. Ye shall not sow, neither reap that which growth of itself in it, no gather the grapes in it of they vine undressed."

25:12 "For it is the jubilee; it shall be holy unto you: ye shall eat the increase thereof out of the field."

<sup>23</sup> "The major cycle of stocks occurs every 49 to 50 years. A period of "jubilee" years of extreme high or low prices, lasting 5 to 7 years occur at the end of the 50-year cycle." *Method For Forecasting The Stock Market*, 1931. Republished in *Rare Writings of WD Gann*.

### 50-YEAR PERIOD OF "JUBILEE"

Table 8.1 lists the details of each 13-year cycle from 1924 to 2000. The average duration was 12.6 years, or 12 years and 7 months. 12.6 is one-fourth of the "Period of Jubilee".

The 17-year cycle divides the 50-year "Period of Jubilee" by three, and the 13-year cycle divides it by four. This is a common harmonic integral division of a cycle producing the musical fifth and fourth. *Four-Dimensional Stock Market Structures And Cycles* explored this phenomenon in detail and Figure 8.1 reproduces one relevant figure from that work. The fundamental tone or cycle is divided an integral number of times to arrive at various musical and harmonic tones.

Beginning Date	Ending Date	Duration
10/20/1987	1/14/2000 (DJIA)	4,469 days = 12y 2m 25d
	3/10/2000 (NASDAQ)	4,525 days = 12y 4m 19d
	9/1/2000 (SP500)	4,700 days = 12y 10m 12d
12/9/1974	10/20/1987	4,698 days = 12y 10m 11d
6/25/1962	12/9/1974	4,550 days = 12y 5m 14d
6/14/1949	6/25/1962	4,759 days = 13y 0m 11d
3/10/1937	6/14/1949	4,479 days = 12y 3m 4d
5/20/1924	3/10/1937	4,677 days = 12y 9m 18d
9/25/1911	5/20/1924	4,621 days = 12y 7m 25d
4/25/1899	9/25/1911	4,535 days = 12y 5m 0d
4/25/1899	1/14/2000	<u>Average of above 8 cycles:</u> DJIA (top 1/2000) = 4,605.5 days ≈ 12y 7m ≈ 151 months ≈ 658 wks SP500 (top 9/2000) = 4,627 days ≈ 12y 8m ≈ 152 months ≈ 661 wks

**Table 8.1**  
13-year stock market cycles, 1899-2000.

The same principle of harmonic division can be applied to market cycles. Figure 8.2 presents a timeline with the harmonic division of the Uranus cycle into the 17-year, 13-year, and Jubilee cycles. Notice on this figure that two Periods of Jubilee completed between 1899 and 2000.

During this time Uranus moved  $432^{\circ}$ , or one complete  $360^{\circ}$  and an additional  $72^{\circ}$ . It will be shown later in this work that 17-year sections tend to have matching inverted patterns after two Periods of Jubilee where the pattern of bottoms/tops match the pattern of tops/bottoms ~101 years later.



Six 13-year cycles in weekly DJIA 1924-2000

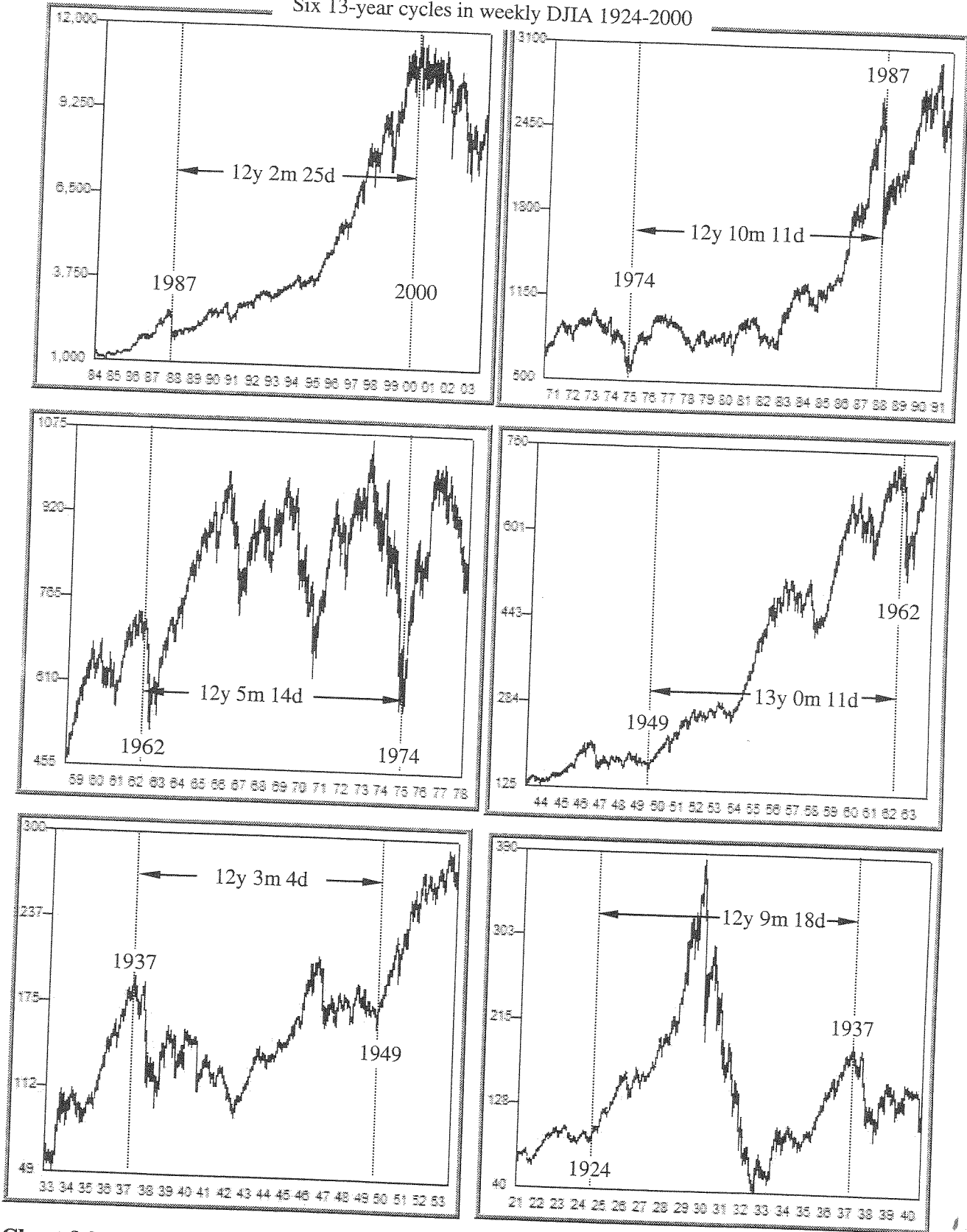
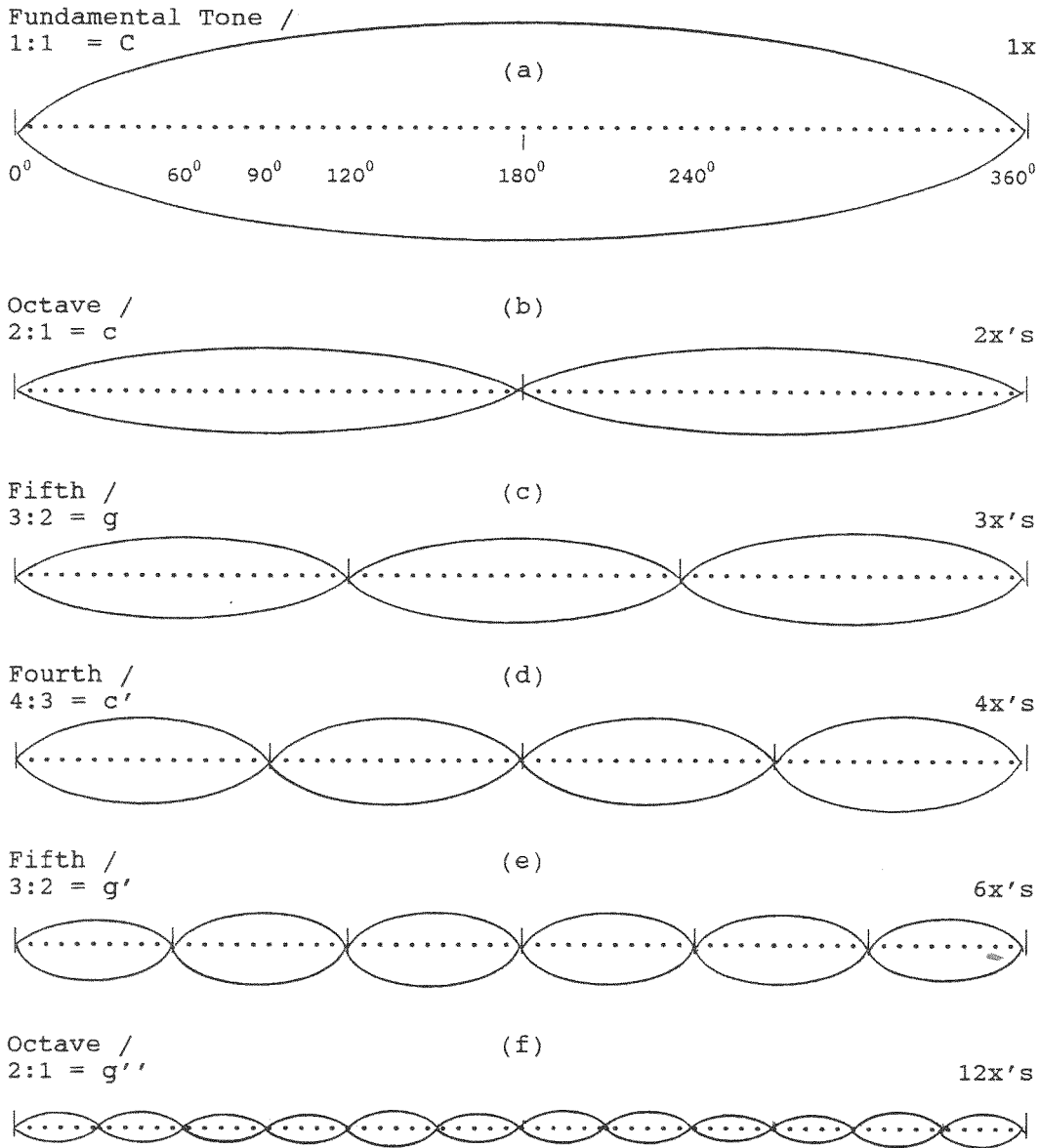


Chart 8.2  
13-year cycles in weekly DJIA, 1924 - 2000.

Musical Interval and  
Corresponding Frequency Ratio

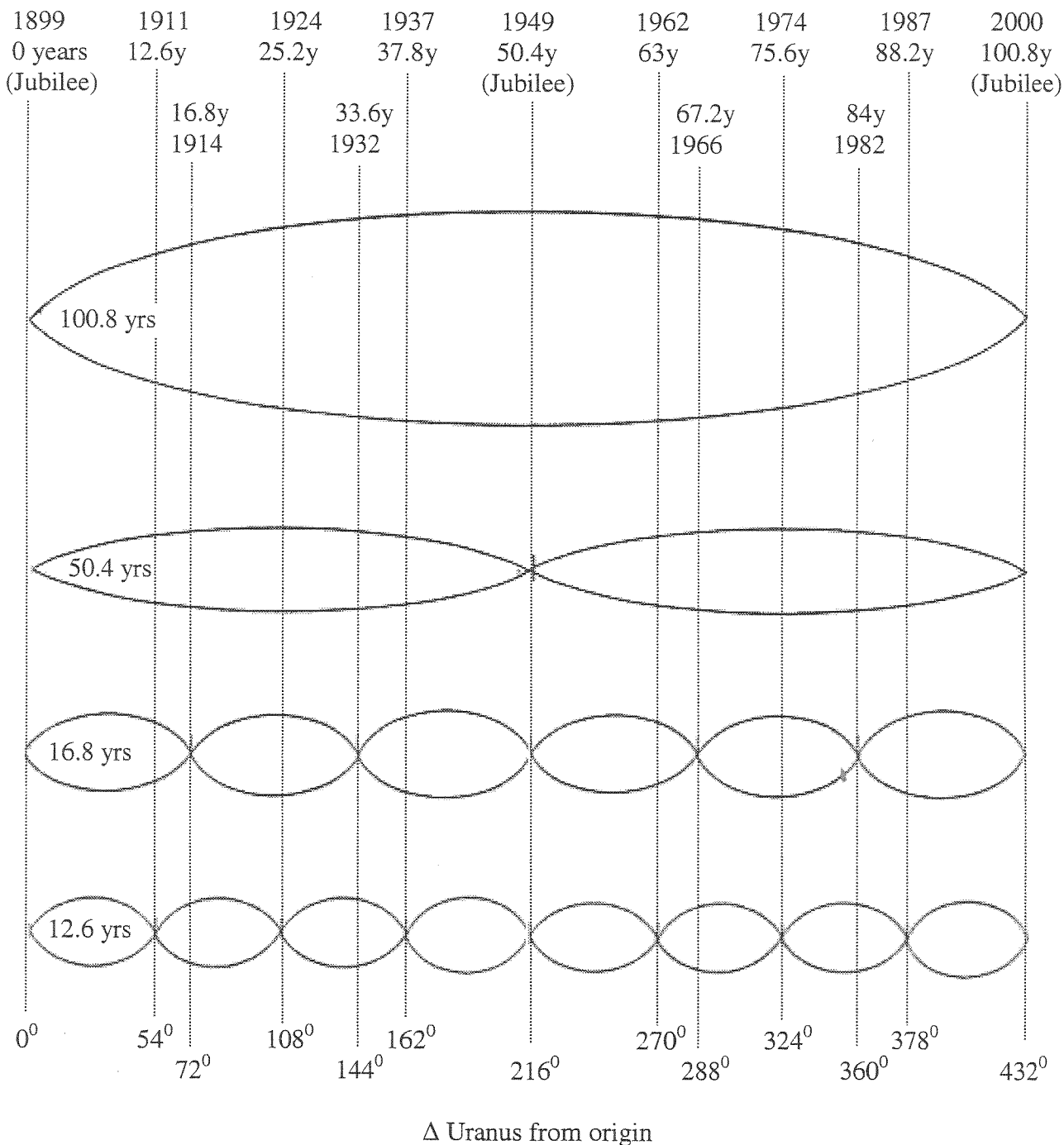
Frequency Ratio to  
Fundamental Tone



**Figure 8.1**

Standing waves in a vibrating string with corresponding musical tones.  
Reproduced from *Four-Dimensional Stock Market Structures And Cycles*.

Cycle Timeline in Years



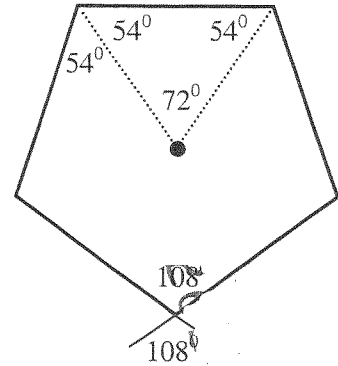
**Figure 8.2**

Harmonic division of the Uranus cycle into Jubilee, 17-year, and 13-year cycles.

**THE URANUS PENTAGRAM  
AND THE 13-YEAR CYCLE**

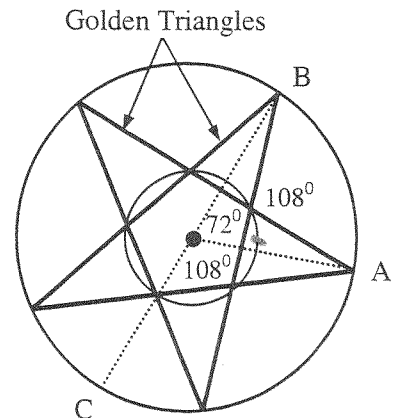
There are two angles in a symmetrical pentagon,  $72^{\circ}$  and  $108^{\circ}$ . The inner angle of  $72^{\circ}$  correlates the movement of Uranus with the 17-year stock market cycle. Harmonic subdivision of the Uranus= $72^{\circ}$  cycle into  $36^{\circ}$  and  $18^{\circ}$  correlate with the  $8\frac{1}{2}$ -year (104 months) and  $4\frac{1}{4}$ -year (52 month) cycles.

$108^{\circ}$  is the outer angle of a pentagon connecting adjoining sides. Its bisector,  $54^{\circ}$ , forms the base angles of the pentagon's five isosceles triangles.



**Figure 8.3**  
Pentagon outer angle =  $108^{\circ}$

Figure 8.4 shows that  $108^{\circ}$  is the angle between the five Golden Triangles attached to the central pentagon. As seen from the center of the pentagon, an angle of  $72^{\circ}$  is swept out between the five pentagonal points, such as A to B. Viewed from the circumference of the inner circle, an angle of  $108^{\circ}$  is swept out between these same two points. Whether  $72^{\circ}$  or  $108^{\circ}$  is seen depends on the location of the observer.



**Figure 8.4**  
Angle between two pentagram Golden Triangles is  $108^{\circ}$

$108^{\circ}$  is also the supplementary angle to  $72^{\circ}$ , meaning their sum is  $180^{\circ}$ . Viewed from the center, the angle between A and C is  $108^{\circ}$ . The  $180^{\circ}$  point, B to C, has already been shown to define mid-cycle panics and acceleration bottoms within 17-year cycles.

Figure 8.3 shows that the inner angles of the five triangles composing the pentagon are  $54^{\circ}$ ,  $54^{\circ}$ , and  $72^{\circ}$ . The  $72^{\circ}$  division of Uranus corresponds with the 16.8-year stock market cycle.

$$\left( \frac{72^{\circ}}{360^{\circ}} \right) \times 84 \text{ years} = 16.8 \text{ years}$$

Dividing the complete Uranus  $360^{\circ}$  cycle of 84 years into  $54^{\circ}$  increments results in 12.6

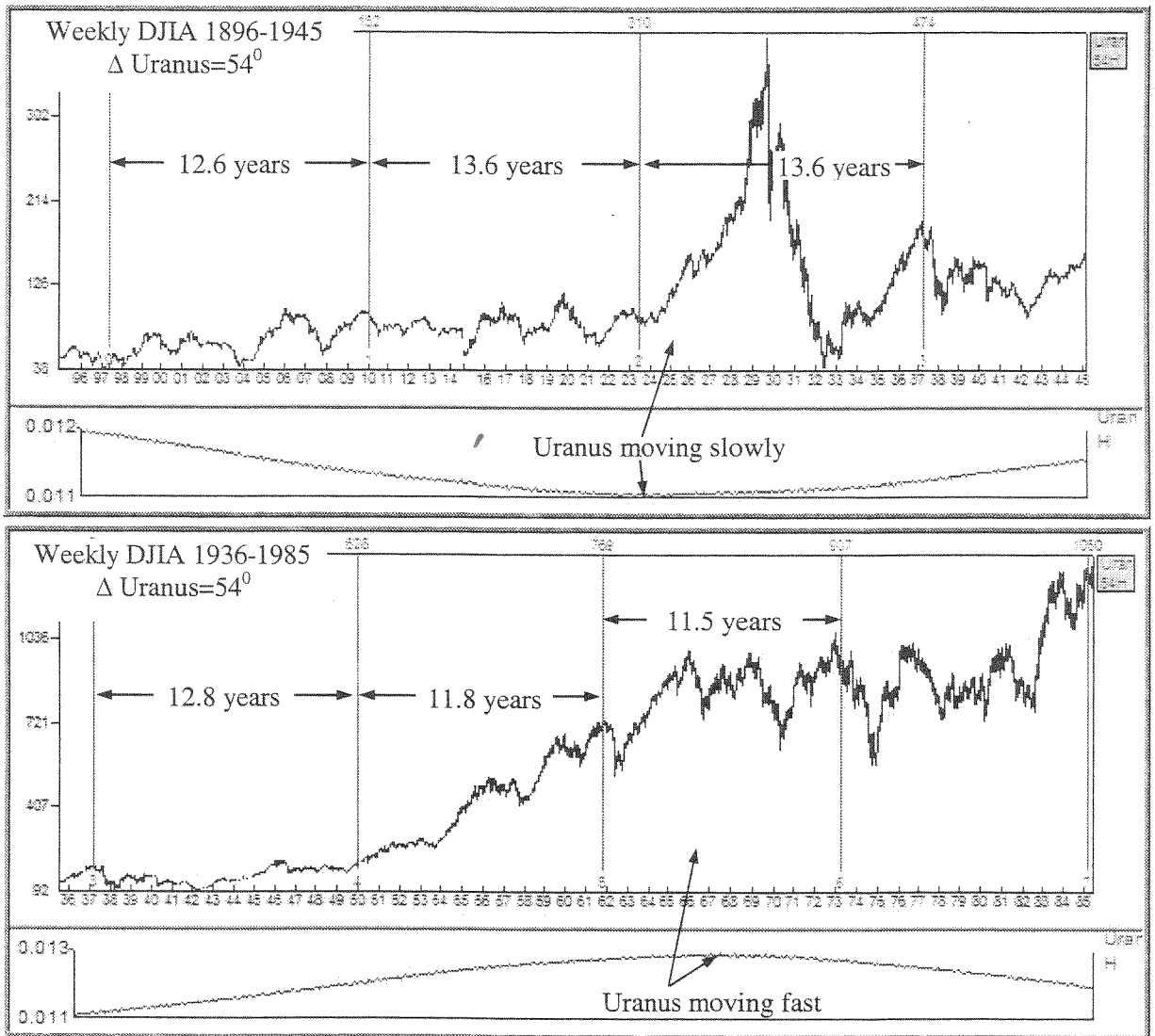
years, which corresponds with the measured average of the six 13-year cycles between 1949 and 2000 shown in Table 8.1.

$$\left( \frac{54^{\circ}}{360^{\circ}} \right) \times 84 \text{ years} = 12.6 \text{ years}$$

Due to its changing speed the time it took Uranus to move  $54^\circ$  varied from 11.5 to 13.6 years during one complete Uranus cycle, 1897-1982. In the 1960s when Uranus was close to the sun and moving fast it only took 11.5 years. One-half cycle earlier in the 1920s Uranus was at aphelion and moving slowly and it took 13.6 years to move  $54^\circ$ .

Because the 13-year stock market cycle has been measured to repeat consistently with a much narrower time window, there must be other smaller cycles resonating with this Uranus cycle providing more consistency.

The next cycle to add to the wheels-within-wheels is Jupiter.



**Chart 8.3**

$\Delta \text{Uranus} = 54^\circ$  in DJIA. 1896-1945 (top), 1936-1985 (bottom)

**THE "MARK OF THE BEAST"  
CYCLE OF 666 WEEKS**

*Here is wisdom. Let him that hath understanding count the number of the beast: for it is the number of a man; and his number is Six hundred threescore and six. ...Revelation 13:18*

Anyone involved in trading who lived through the 1962, 1974, 1987, and 2000 panics would agree that these times seemed like financial "Hell on Earth". Panic and fear spread from the financial markets throughout most of society. People worried about their futures, lost their life's work, lost their jobs, their homes, and some lost even more. A general feeling of despair permeated society. While not wanting to seem too cryptic with the numerical analysis, these panics were closely tied to astronomical cycles spaced 666 weeks apart.

Figure 7.1 showed how the Saturn-Uranus clock advances one click of  $30^\circ$  beyond  $360^\circ$  with two conjunctions. The first pair of conjunctions occur  $180^\circ$  apart and the third conjunction is  $210^\circ$  from the second, meaning three conjunctions lasting 90 years occur  $390^\circ$  ( $180^\circ + 210^\circ$ ) apart. This one sign rotation occurs because Uranus completes  $360^\circ$  in 84 years, and two Saturn-Uranus conjunctions take 90 years.

The same principle is at work with Jupiter and the "Mark of the Beast" cycle of 666 weeks. Jupiter revolves  $360^\circ$  in 11.86 years, or 619 weeks. At the end of one complete orbit its clock advances one  $30^\circ$  tick to complete a 13-year cycle of  $390^\circ$ .

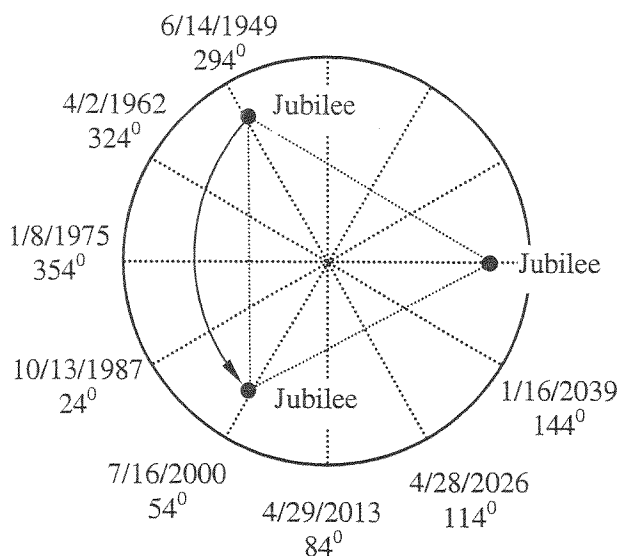
Figure 8.5 shows that at the bottom in 1949 Jupiter was at  $294^\circ$ . Thirteen years later, at the April 1962 top, Jupiter had advanced one complete cycle plus an additional  $30^\circ$  to  $324^\circ$ .

When the bottom of the market finally arrived in December 1974 Jupiter was at  $354^\circ$ , or  $390^\circ$  from the 1962 top.

The "crash of 1987" saw Jupiter move  $390^\circ$  from the 1974 bottom to  $24^\circ$ . This is one of the points on the Uranus pentagram, the same location as Uranus at the 2/1933 bottom, and the location of Saturn at the 1792 signing of the Buttonwood Agreement.

The complete 'Period of Jubilee' from 1949 to 2000 saw the Jupiter cycle migrate  $120^\circ$ . It takes three such periods for the Jupiter clock to advance all the way around the zodiac and return to its starting position.

Chart 8.4 shows the  $390^\circ$  Jupiter cycle of 666 weeks corresponds very closely with stock market panics. The SP500 is used for the 1987-2000 cycle because it provides a much clearer top formation. It is a much more comprehensive index to use for cycle analysis but doesn't have the historical database of the DJIA.



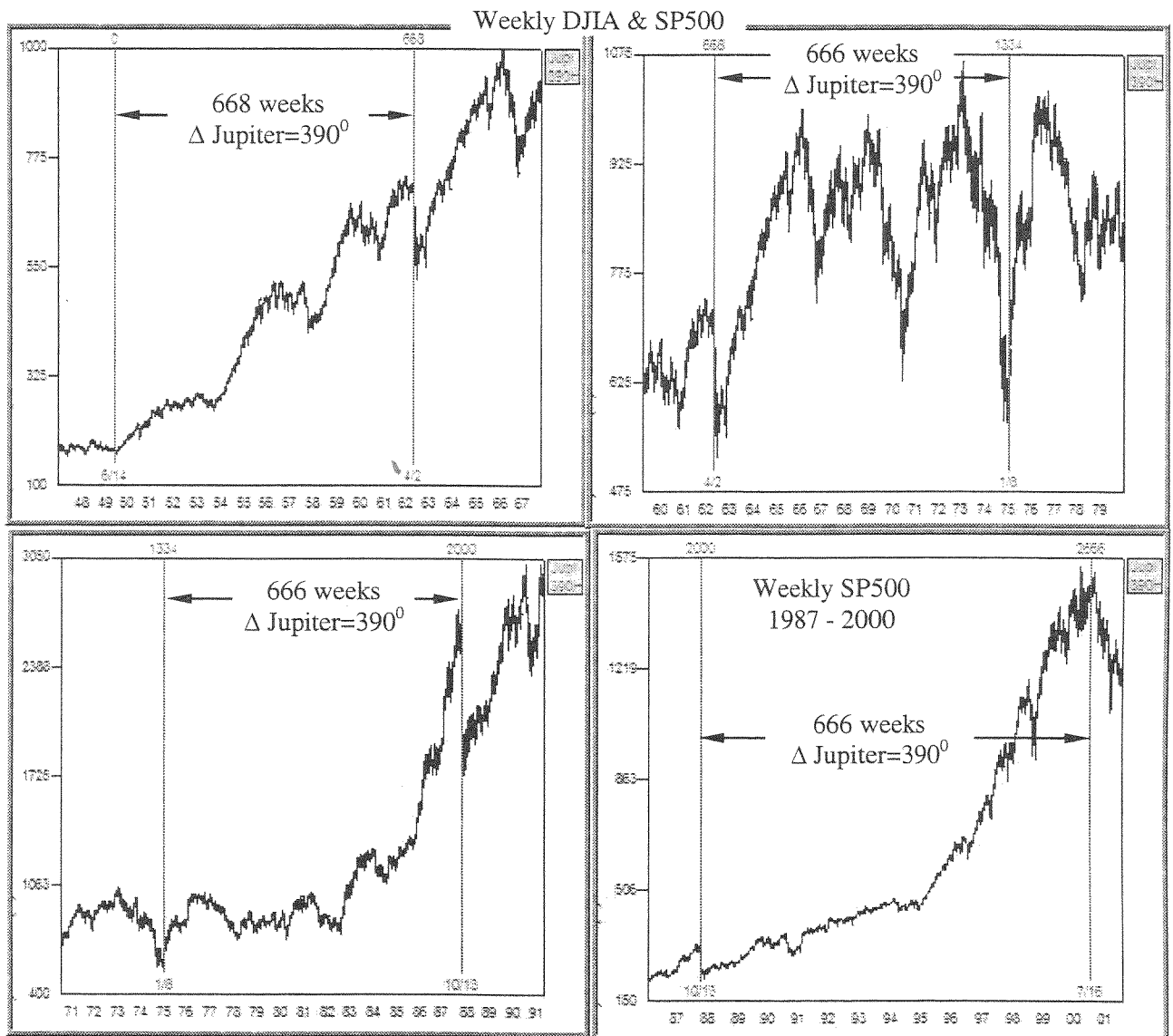
**Figure 8.5**  
Jupiter  $390^\circ$ , the ~50-year 'Period of Jubilee', and the 666-week "Mark of the Beast" cycle.

The cycles were computer generated and based solely on  $\Delta \text{Jupiter}=390^0$  with the same 6/14/1949 origin. The weekly time counts from 1949 are printed at the top of the cycles. The first cycle of 668 weeks is the only one that was not exactly 666 weeks.

The next section will show this same cycle is closely synchronized with the motions of the inner planets, Venus and Earth. This will provide the link between the outer and inner planets, the Square of Twelve, the pentagram, and stock market cycles.

Table 8.1 showed that the duration of the 1987-2000 cycle in the SP500 was only two days less than the 1974-1987 cycle, both corresponding to  $\Delta \text{Jupiter}=390^0$ .

Later chapters will include Mars and Ceres, showing how all these planets are in harmony with the 666-week cycle.



**Chart 8.4**  
 $\Delta \text{Jupiter}=390^0$  and the "Mark of the Beast" cycle of 666 weeks.

## **PENTAGONAL EARTH-VENUS CYCLES**

The analysis to this point has studied the slower moving outer planets. It will now be shown that the inner planets move in harmony with their larger outer cousins. Identifying and projecting these smaller cycles allows the timing window to be significantly narrowed. The motions of Venus and Earth will be studied together with the Square of Twelve and the pentagram. Finally, these cycles will be shown together with the Jupiter=390<sup>0</sup> cycle to connect the inner and outer planets.

Later chapters will show that the Venus-Earth-Mars trio are pentagonal fractals of Jupiter-Saturn-Uranus. This fractal takes the form of rotating Golden Triangles imprinting time pentagrams in the zodiac.

Other than the Sun and Moon, Venus is the brightest object in the sky. That big bright star that most people marvel at is actually not a star at all, rather one of only two planets orbiting closer to the Sun than Earth. The small and fast moving Mercury is rarely noticed because it is only occasionally visible right after sunset or before sunrise.

Without doubt Venus received a great deal of attention from our ancestors as they tried to connect to the spiritual world by studying the movements of the heavens. The temples and monuments found throughout the ancient world were many times based on the motions of the heavens, the Square of Twelve, and the pentagram. Because the planets beyond Saturn are not visible to the naked eye they had no knowledge of Uranus and its pentagonal cycles. Without telescopes they could not have made many of the pentagonal measurements studied thus far in this work. As will now be shown, there was no need to study Uranus because

big bright Venus provided them with the same pentagonal symmetry found in the outer planets.

## **FIRST AND SECOND-ORDER EARTH-VENUS CONJUNCTIONS**

The first step in understanding any market astro cycle is to develop an understanding of the basic mechanics of planetary motion. Software helps this process considerably because it quickly does all the time consuming "grunt work" of repetitive calculations.

Table 8.2 shows the data for 13 successive conjunctions of Earth-Venus starting in 1950. Column #7 shows the synodic angle is zero meaning they are in conjunction.

A quick scan down column #3, Longitude, shows that each successive conjunction occurred ~216<sup>0</sup> (72<sup>0</sup> x 3) from the previous one and the fifth conjunction occurred in 1958 at the same location in the zodiac as the first. Both of these conjunctions are circled in the table. The conjunctions migrated around the zodiac until finally returning to the original location after eight years. The 1958 conjunction is only three days less than exactly eight years from the first conjunction in 1950. These are called "first-order conjunctions" because they occur in the same zodiac location.<sup>24</sup>

*Four-Dimensional Stock Market Structures And Cycles* briefly explored this phenomenon with the 60-year Jupiter-Saturn first-order conjunctions.

---

<sup>24</sup> Reference, *Encyclopedia of Astrology*, Nicholas DeVore.



Every fifth conjunction of Venus and Earth occurs at the same zodiac location after eight years.

Axis	Planet	Longitude	Date	Hour	Minute	Synodic	Change	Change (From Start)	Calendar Days
0	Venus	130°49'38.563"	1/31/1950	6	37.18	0°00'00.004"	N/A	N/A	0
	Earth	130°49'38.559"							
1	Venus	340°18'07.536"	9/3/1951	15	4.97	0°00'00.004"	360°00'00.000"	360°00'00.000"	580.35263
	Earth	340°18'07.532"							
2	Venus	203°06'09.022"	4/13/1953	8	11.73	0°00'00.004"	360°00'00.000"	720°00'00.000"	1168.06566
	Earth	203°06'09.018"							
3	Venus	52°23'41.821"	11/15/1954	7	22.64	0°00'00.005"	360°00'00.000"	1080°00'00.000"	1749.03157
	Earth	52°23'41.817"							
4	Venus	270°46'56.084"	6/22/1956	6	5.42	0°00'00.004"	360°00'00.000"	1440°00'00.000"	2333.97794
	Earth	270°46'56.079"							
5	Venus	128°24'01.398"	1/28/1958	19	43.53	0°00'00.004"	360°00'00.000"	1800°00'00.000"	2919.54607
	Earth	128°24'01.394"							
6	Venus	338°04'20.981"	9/1/1959	6	19.53	0°00'00.004"	360°00'00.000"	2160°00'00.000"	3499.98774
	Earth	338°04'20.976"							
7	Venus	200°51'31.309"	4/10/1961	23	47.41	0°00'00.004"	360°00'00.000"	2520°00'00.000"	4087.71543
	Earth	200°51'31.305"							
8	Venus	49°57'33.140"	11/12/1962	20	3.35	0°00'00.004"	360°00'00.000"	2880°00'00.000"	4668.55984
	Earth	49°57'33.136"							
9	Venus	268°38'06.321"	6/19/1964	22	37.05	0°00'00.004"	360°00'00.000"	3240°00'00.000"	5253.66658
	Earth	268°38'06.317"							
10	Venus	125°56'41.672"	1/26/1966	8	34.26	0°00'00.004"	360°00'00.000"	3600°00'00.000"	5839.08131
	Earth	125°56'41.667"							
11	Venus	335°50'50.833"	8/29/1967	21	37.41	0°00'00.004"	360°00'00.000"	3960°00'00.000"	6419.62516
	Earth	335°50'50.829"							
12	Venus	198°35'58.999"	4/8/1969	15	7.24	0°00'00.004"	360°00'00.000"	4320°00'00.000"	7007.35421
	Earth	198°35'58.994"							
13	Venus	47°32'37.909"	11/10/1970	8	45.94	0°00'00.004"	360°00'00.000"	4680°00'00.000"	7588.08942
	Earth	47°32'37.904"							

Table 8.2

First-order Earth-Venus conjunctions recur every eight years.

Figure 8.6 provides a better conceptual view of the mechanics of the Earth-Venus cycle by showing the zodiac locations of six successive conjunctions between 1950-1958. Conjunctions #1 and #6 are first-order, 2, 3, 4, and 5 are second-order, occurring at different zodiac locations. The diagram shows that the sixth conjunction is simply a repeat of the first eight years earlier.

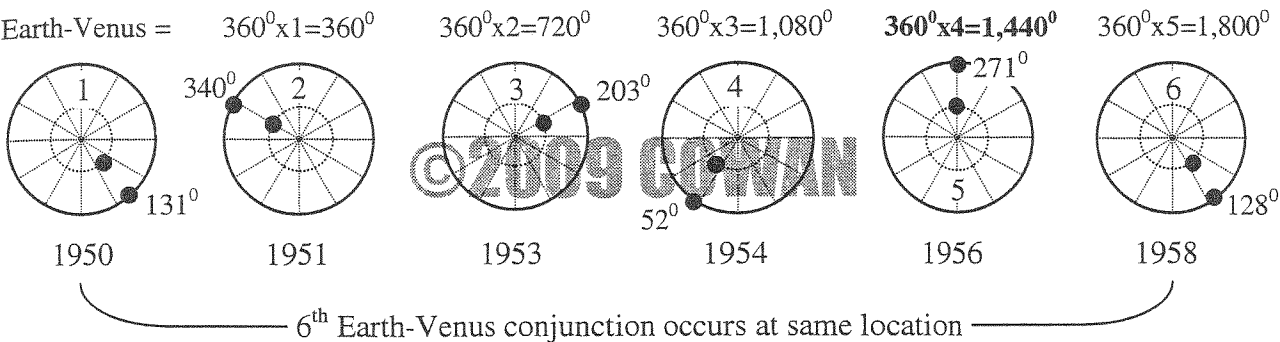
The total cumulative degrees traveled by Earth-Venus from the first conjunction are shown at the top. One conjunction is 360°.

The fifth conjunction has special significance because it is the last

conjunction before they begin to repeat at the same location. When the fifth conjunction completed in 1956 all five points of a pentagram had been formed, with the total Δ Earth-Venus = 1,440°.

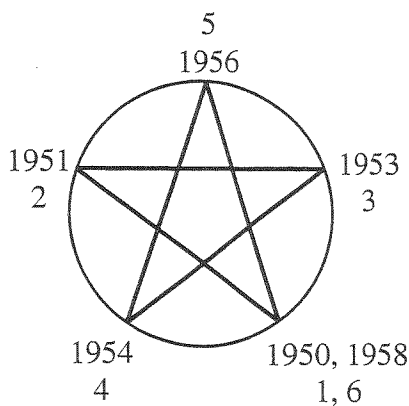
This was explained earlier with the Uranus cycle completing 5 points on its pentagram after moving 288° between 1897-1966.

Figure 8.7 makes this pentagonal pattern clear by plotting all six conjunctions on the same zodiac circle. The numbers, dates, and zodiac locations in this figure correspond with those in Figure 8.6.



**Figure 8.6**  
Locations of six successive Earth-Venus conjunctions, each advances  $216^\circ$ .

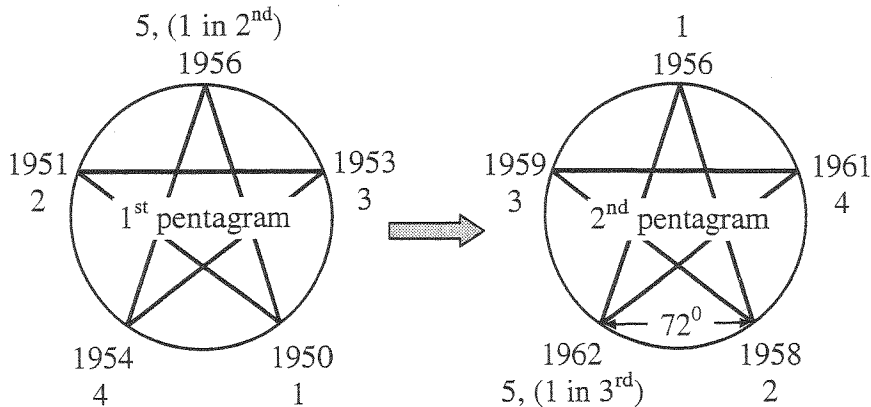
Figure 8.7 shows that five points of the pentagram were defined in 1956 after the fifth conjunction. The sixth conjunction in 1958 was a repeat of the first and the second point in the second forming pentagram. The first point in the second pentagram was in 1956.



**Figure 8.7**  
Five successive Earth-Venus conjunctions form a pentagram.

The reader must understand this critically important concept because later chapters will show the Earth-Venus-Mars trio form repeating Golden Triangles that rotate clockwise  $72^\circ$  between successive 13-year stock market panics.

Figure 8.8 shows the first two Earth-Venus pentagrams beginning at the 1950 conjunction. The fifth conjunction in 1956 completed pentagram #1 and started pentagram #2. The second pentagram completed in 1962 at a point in the zodiac rotated  $72^\circ$  clockwise from the first point of pentagram #1.



**Figure 8.8**  
Two Earth-Venus pentagrams rotated  $72^\circ$  complete in 13 years.

The second pentagram completes after  $\Delta$  Earth-Venus =  $2,880^\circ$  ( $360^\circ \times 8$ ) total cumulative degrees from the 1950 start. This is the basis of the Earth-Venus-Mars 13-year cycle.

The pattern has now been identified. Every  $1,440^{\circ}$  displacement of the Earth-Venus cycle plots five points of a pentagram spanning  $6\frac{1}{2}$  years. Two pentagrams complete in 13 years after  $\Delta$  Earth-Venus  $=2,880^{\circ}$ . The ending point of pentagram #2 (and starting point of #3) is rotated  $72^{\circ}$  clockwise from the start of #1.

The chapter *The Great Pentagram* includes Mars into this arrangement, showing how beautifully organized the planetary cycles are with pentagonal time symmetry.

**FIRST AND SECOND-ORDER EARTH-VENUS RECURRENCE CYCLES**

The planets do not have to be in conjunction for the same principles to apply. Regardless of the angle between them, Earth-Venus will return to the same zodiac locations every fifth  $360^{\circ}$  recurrence. For example, Table 8.5 shows the angle between Earth and Venus was  $144^{\circ}$  at the October 20<sup>th</sup> low of the "crash of 1987". Five  $360^{\circ}$  cycles later

Earth and Venus returned to the same locations in the zodiac. In this same time Earth completed eight  $360^{\circ}$  orbits and Venus thirteen. The angle between them was again  $144^{\circ}$ . This is known as a "first-order recurrence cycle".

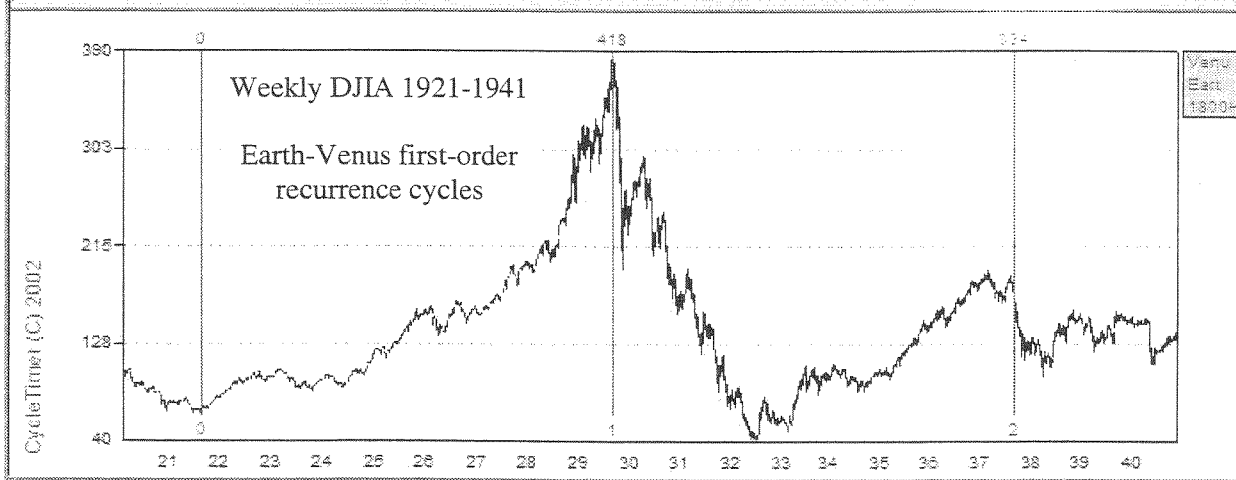
Chart 8.5 shows the 8-year first-order Earth-Venus recurrence cycles during 1921-1937.

Charts 8.6 and 8.7 show more examples originating at the 1966 bottom when the angle between them was again  $144^{\circ}$ . Every eight years Earth and Venus returned to the same zodiac locations corresponding with major bottoms in 1974, 1982, 1990, and 1998.

Two major points to remember about the Earth-Venus cycle are:

1. A first-order recurrence cycle occurs every fifth cycle, or  $1,800^{\circ} = 8$  years.
2. All five pentagram points are in place after four cycles, or  $1,440^{\circ} = 6\frac{1}{2}$  years.

Axis	Planet	Longitude	Date	Hour	Minute	Synodic Angle	Change	Change (From)	Calendar Days
0	Venus	63°29'43.286"	9/2/1921	15	60	83°52'45.878"	N/A	N/A	0
	Earth	339°36'57.408"							
1	Venus	61°19'21.607"	8/31/1929	8	38.66	83°52'45.878"	1800°00'00.000"	1800°00'00.000"	2919.69351
	Earth	337°26'35.729"							
2	Venus	59°09'07.506"	8/29/1937	1	5.53	83°52'45.878"	1800°00'00.000"	3600°00'00.000"	5839.37884
	Earth	335°16'21.627"							



**Chart 8.5**  
Earth-Venus first-order recurrence cycles, 1921-1941.

Axis	Planet	Longitude	Date	Hour	Minute	Change (Previous)	Change (From Start)	Calendar Days
0	Venus	242°39'08.334"	10/20/1987	0	0	N/A	N/A	0
1	Venus	242°39'08.334"	5/31/1988	16	36.9	360°00'00.000"	360°00'00.000"	224.69229
2	Venus	242°39'08.334"	1/11/1989	9	13.92	360°00'00.000"	720°00'00.000"	449.38466
3	Venus	242°39'08.334"	8/24/1989	1	54.62	360°00'00.000"	1080°00'00.000"	674.0796
4	Venus	242°39'08.334"	4/5/1990	18	42.55	360°00'00.000"	1440°00'00.000"	898.77955
5	Venus	242°39'08.334"	11/16/1990	11	22.45	360°00'00.000"	1800°00'00.000"	1123.47393
6	Venus	242°39'08.334"	6/29/1991	4	0.89	360°00'00.000"	2160°00'00.000"	1348.16728
7	Venus	242°39'08.334"	2/8/1992	20	43.12	360°00'00.000"	2520°00'00.000"	1572.86327
8	Venus	242°39'08.334"	9/20/1992	13	24.47	360°00'00.000"	2880°00'00.000"	1797.55866
9	Venus	242°39'08.334"	5/3/1993	6	4.55	360°00'00.000"	3240°00'00.000"	2022.25316
10	Venus	242°39'08.334"	12/13/1993	22	43.28	360°00'00.000"	3600°00'00.000"	2246.94672
11	Venus	242°39'08.334"	7/26/1994	15	24.01	360°00'00.000"	3960°00'00.000"	2471.64167
12	Venus	242°39'08.334"	3/8/1995	8	14.6	360°00'00.000"	4320°00'00.000"	2696.34347
13	Venus	242°39'08.334"	10/19/1995	0	56.18	360°00'00.000"	4680°00'00.000"	2921.03901

Table 8.3

Thirteen repetitions of  $\Delta$  Venus=360° from the 10/20/1987 crash low.

Axis	Planet	Longitude	Date	Hour	Minute	Change (Previous Axis)	Change (From Start)	Calendar Days
0	Earth	26°03'35.439"	10/20/1987	0	0	N/A	N/A	0
1	Earth	26°03'35.439"	10/19/1988	5	40	360°00'00.000"	360°00'00.000"	365.23611
2	Earth	26°03'35.439"	10/19/1989	11	32.16	360°00'00.000"	720°00'00.000"	730.48066
3	Earth	26°03'35.439"	10/19/1990	17	12.4	360°00'00.000"	1080°00'00.000"	1095.71694
4	Earth	26°03'35.439"	10/19/1991	23	0.02	360°00'00.000"	1440°00'00.000"	1460.95834
5	Earth	26°03'35.439"	10/19/1992	4	55.41	360°00'00.000"	1800°00'00.000"	1826.20515
6	Earth	26°03'35.439"	10/19/1993	10	35.07	360°00'00.000"	2160°00'00.000"	2191.44102
7	Earth	26°03'35.439"	10/19/1994	16	31.29	360°00'00.000"	2520°00'00.000"	2556.6884
8	Earth	26°03'35.439"	10/19/1995	22	30.26	360°00'00.000"	2880°00'00.000"	2921.93768
9	Earth	26°03'35.439"	10/19/1996	4	14.96	360°00'00.000"	3240°00'00.000"	3287.17705
10	Earth	26°03'35.439"	10/19/1997	10	10.73	360°00'00.000"	3600°00'00.000"	3652.42412

Table 8.4

Ten repetitions of  $\Delta$  Earth=360° from the 10/20/1987 crash low.

Axis	Planet	Longitude	Date	Synodic Angle	Change	Change (From Start)	Calendar Days
0	Venus	242°39'08.334"	10/20/1987	143°24'27.105"	N/A	N/A	0
	Earth	26°03'35.439"					
1	Venus	107°26'48.054"	6/1/1989	143°24'27.105"	360°00'00.000"	360°00'00.000"	590.38567
	Earth	250°51'15.158"					
2	Venus	320°04'25.807"	1/4/1991	143°24'27.105"	360°00'00.000"	720°00'00.000"	1172.36322
	Earth	103°28'52.911"					
3	Venus	171°48'00.977"	8/7/1992	143°24'27.105"	360°00'00.000"	1080°00'00.000"	1753.48654
	Earth	315°12'28.081"					
4	Venus	36°51'14.294"	3/21/1994	143°24'27.105"	360°00'00.000"	1440°00'00.000"	2344.11677
	Earth	180°15'41.398"					
5	Venus	240°16'52.614"	10/17/1995	143°24'27.105"	360°00'00.000"	1800°00'00.000"	2919.5501
	Earth	23°41'19.719"					
6	Venus	105°21'09.214"	5/30/1997	143°24'27.105"	360°00'00.000"	2160°00'00.000"	3510.13655
	Earth	248°45'36.319"					
7	Venus	317°28'44.872"	1/1/1999	143°24'27.105"	360°00'00.000"	2520°00'00.000"	4091.76722
	Earth	100°53'11.977"					
8	Venus	169°42'28.310"	8/5/2000	143°24'27.105"	360°00'00.000"	2880°00'00.000"	4673.2441
	Earth	313°06'55.414"					
9	Venus	34°28'44.193"	3/18/2002	143°24'27.105"	360°00'00.000"	3240°00'00.000"	5263.67769
	Earth	177°53'41.297"					
10	Venus	237°55'47.140"	10/15/2003	143°24'27.105"	360°00'00.000"	3600°00'00.000"	5839.11937
	Earth	21°20'14.244"					

Table 8.5

Ten repetitions of  $\Delta$  Earth-Venus=360° from 10/1987 crash. Two first-order recurrence cycles.

First-order recurrence cycles

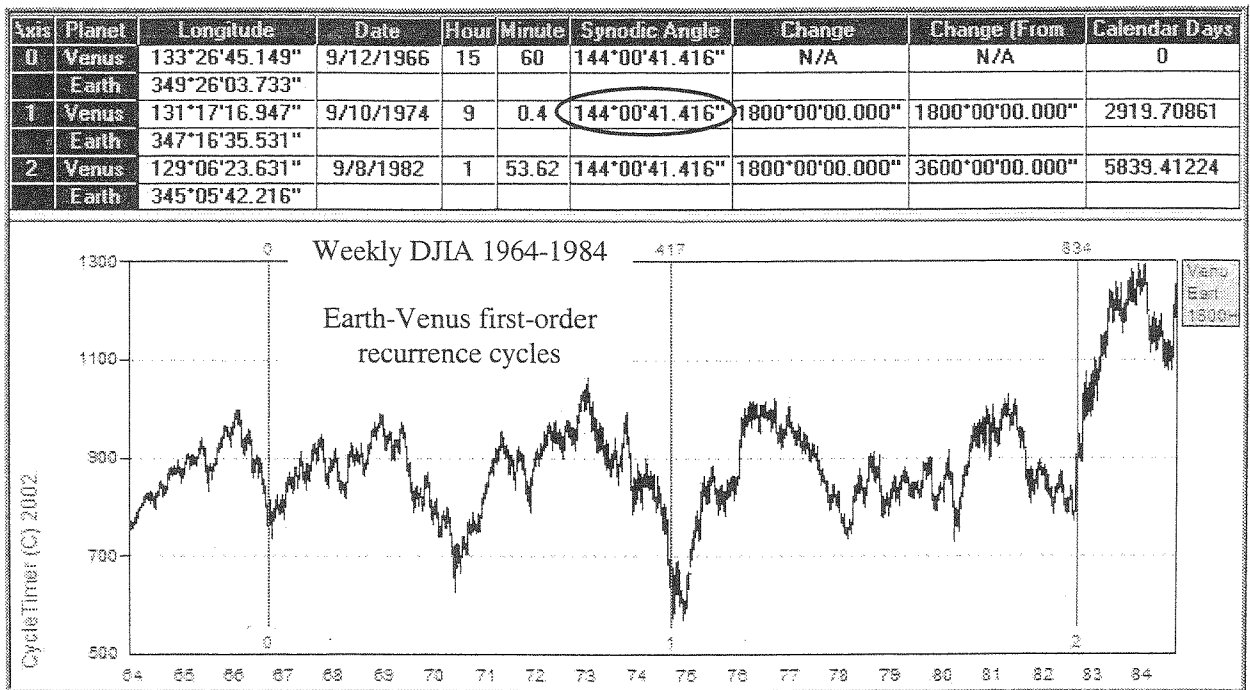


Chart 8.6

Eight-year first-order Earth-Venus recurrence cycles, 1966-1982.

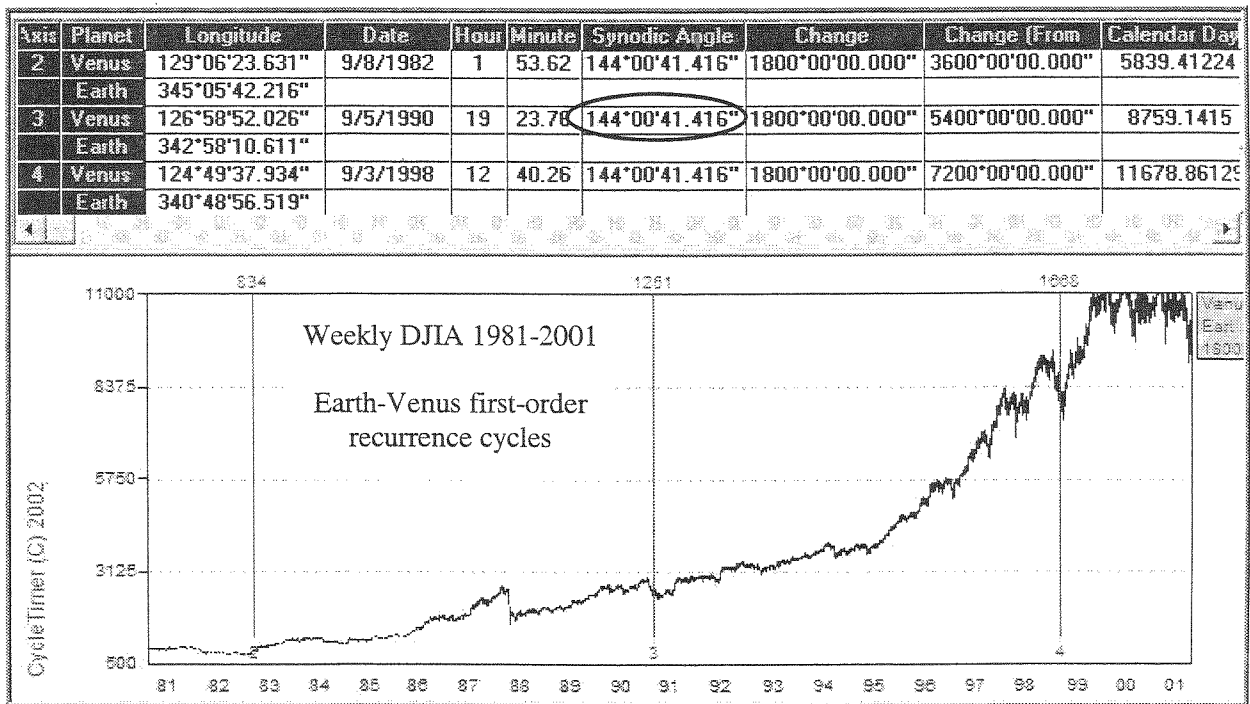


Chart 8.7

Eight-year first-order Earth-Venus recurrence cycles, 1982-1998.

**THE FOURTH SQUARE OF TWELVE AND THE EARTH-VENUS CYCLE**

The Squares of Twelve are 144, 288, 432, and 576, etc. Gann wrote about the Square of Twelve in one of his earliest courses *Method For Forecasting The Stock Market*, 1931. In 1955 he republished that material in his *Master Charts* course. Sections of his *Master Course* referring to the Square of Twelve are included in Appendix D. In "*The Master Mathematical Price Time And Trend Calculator*"<sup>25</sup> he wrote:

*"The square of 144 is the GREAT SQUARE and works better than any other square both for TIME AND PRICE because it contains all the squares from 1 to 144."*

Because planetary cycles vary over time, precise measurements of their periods need to be made during the time corresponding stock market cycles are studied. Tables 8.3, 8.4, and 8.5 show the calculations for ten recurrences of the 360° cycles of Venus, Earth, and synodic Earth-Venus. The number of days through the tenth cycle is divided by ten to arrive at an average period per cycle.

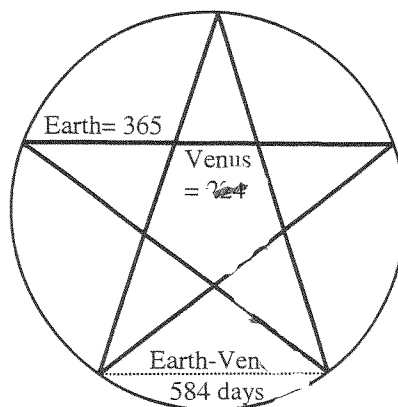
These values show that the periods of Venus and Earth are in the Fibonacci ratio  $\Phi$ .

$$\frac{\text{Earth}}{\text{Venus}} = \frac{365.24}{224.70} = 1.62 = \Phi$$

The synodic period of Earth-Venus is 584 days, nearly equal to the fourth Square of Twelve, 576. Also, the period of Venus is the fourth Square of Twelve divided by  $\Phi^2$ .

$$\begin{aligned} \text{Earth-Venus} &= 583.912 \text{ days} \approx 576 \\ \text{Venus} &= 224.695 \text{ days} \approx (576 / \Phi^2) \end{aligned}$$

Geometrically, these Earth and Venus time relationships are sides of a pentagram. The 224-day Venus cycle is the side length of the inner pentagon. Earth is  $\Phi$  times Venus, or the length of the pentagram arm. The side length of the outer pentagon is the synodic Earth-Venus cycle, averaging 584 days.



**Figure 8.9**  
Pentagonal Earth and Venus cycles.

Figure 8.6 showed that each successive Earth-Venus conjunction advances around the zodiac  $\sim 216^\circ$ , or  $3 \times 72^\circ$ . During this time, Earth and Venus both complete the fourth Square of Twelve.

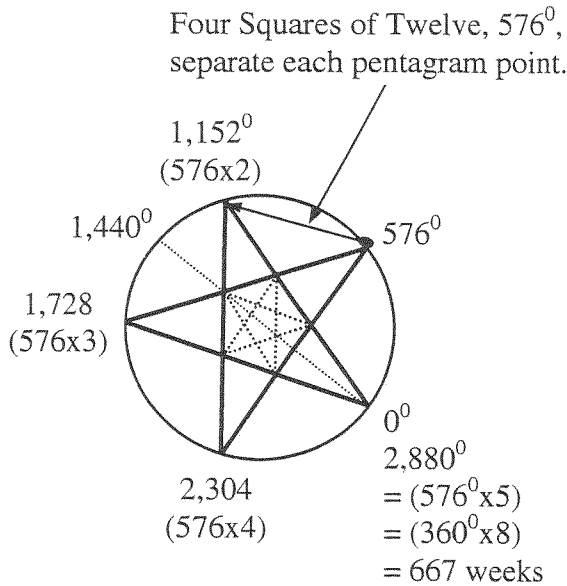
$$\begin{aligned} \Delta \text{ Earth-Venus} &= 360^\circ \\ \Delta \text{ Earth} &= 360^\circ + 216^\circ = 576^\circ \\ \Delta \text{ Venus} &= 720^\circ + 216^\circ = 360^\circ + 576^\circ \end{aligned}$$

The fourth Square of Twelve holds special significance because a square has four sides. WD Gann wrote in his Master course,

*"In the 3<sup>rd</sup> and 4<sup>th</sup> squares of the Master "12", you will find that most of the big bull and bear campaigns culminate, when measured by months which determines the division, according to time. All the other rules given you to apply to Space movements, angles and time, can be used with the Master "12" tables."*

<sup>25</sup> Republished in *Rare Writings of WD Gann*.

The two-pentagram system of the 13-year cycle studied above can be represented as a single pentagram by using the fourth Square of Twelve as the pentagon side length, instead of  $360^{\circ}$ . Figure 8.10 shows that in both cases the total displacement of Earth-Venus is  $2,880^{\circ}$ .



**Figure 8.10**

Five sides of  $576^{\circ}$  complete the pentagram at  $2,880^{\circ}$ .

When four Squares of Twelve complete at 576 they complete four sides of a square. This same  $576^{\circ}$  displacement of the Earth-Venus cycle defines the spacing between two points on a time cycle pentagram. The complete angular displacement of all five sides of the pentagram is,  $5 \times 576^{\circ} = 2,880^{\circ}$  lasting a total of 666-667 weeks.

Tables 8.6-8.8 list several  $576^{\circ}$  cycles for Venus, Earth, and Earth-Venus. The last entry in each of these tables show how the Fibonacci numbers 5, 8, 13 connect these planets, the fourth Square of Twelve, and the 'Mark of the Beast' cycle of 666 weeks.

1. 13 cycles of ( $\Delta \text{ Venus} = 576^{\circ}$ ) =  $7,488^{\circ} = 4,674 \text{ days} = 667 \text{ weeks}$ .
2. 8 cycles of ( $\Delta \text{ Earth} = 576^{\circ}$ ) =  $4,608^{\circ} = 4,674 \text{ days} = 667 \text{ weeks}$ .
3. 5 cycles of ( $\Delta \text{ Earth-Venus} = 576^{\circ}$ ) =  $8 \times (\Delta \text{ Earth-Venus} = 360^{\circ}) = 2,880^{\circ} = 4,674 \text{ days} = 667 \text{ weeks}$ .

Also notice on Figure 8.10 that the halfway point is  $1,440^{\circ}$ , which Figure 8.6 identified as the total displacement of five points on a complete Earth-Venus pentagram using a  $360^{\circ}$  cycle or circle.  $2,880^{\circ}$  was explained to define two such pentagrams using the  $360^{\circ}$  cycle.

**APPLICATIONS OF EARTH-VENUS CYCLES IN THE STOCK MARKET**

Chart 8.8 plots the cycles of Earth and Venus together with the  $\Delta \text{ Jupiter} = 390^{\circ}$  cycle on the monthly DJIA between 1924 and 2000 using a log price scale.

1.  $\Delta \text{ Earth-Venus} = 2,880^{\circ}$
2.  $\Delta \text{ Earth} = 4,608^{\circ}$
3.  $\Delta \text{ Jupiter} = 390^{\circ}$

The origin of all three cycles is the nodal point at the Period of Jubilee in 6/14/1949. These three cycles were all so closely aligned that they look like the same line on the monthly chart.

Because a long-term chart with a log price scale does not show the magnitudes of the moves very well, the 13-year sections are individually expanded for a better view to weekly on Chart 8.9. This also allows the SP500 to be used for the 1987-2000 section showing a much clearer top than does the DJIA. The weekly time counts from the origin are at the tops of each cycle. They are all very close to 666 weeks. The first cycle 1949-1962 was 668 weeks.

Chart 8.10 shows that when 1962 is used as the cycle origin and the charts are zoomed in to daily they coincided closely with the major reversals.

Axis	Planet	Longitude	Date	Hour	Minute	Change (Previous Axis)	Change (From Start)	Calendar Days
0	Venus	120°07'58.814"	6/14/1949	0	0	N/A	N/A	0
1	Venus	336°07'58.814"	6/8/1950	14	40.78	576°00'00.000"	576°00'00.000"	359.61165
2	Venus	192°07'58.814"	6/2/1951	10	47.77	576°00'00.000"	1152°00'00.000"	718.44984
3	Venus	48°07'58.814"	5/27/1952	20	49.67	576°00'00.000"	1728°00'00.000"	1078.86782
4	Venus	264°07'58.814"	5/21/1953	13	53.41	576°00'00.000"	2304°00'00.000"	1437.57876
5	Venus	120°07'58.814"	5/16/1954	13	26.66	576°00'00.000"	2880°00'00.000"	1797.56018
6	Venus	336°07'58.814"	5/11/1955	4	4.39	576°00'00.000"	3456°00'00.000"	2157.16972
7	Venus	192°07'58.814"	5/4/1956	0	20.5	576°00'00.000"	4032°00'00.000"	2516.01423
8	Venus	48°07'58.814"	4/29/1957	10	21.91	576°00'00.000"	4608°00'00.000"	2876.43188
9	Venus	264°07'58.814"	4/23/1958	3	29.37	576°00'00.000"	5184°00'00.000"	3235.14539
10	Venus	120°07'58.814"	4/18/1959	2	56.74	576°00'00.000"	5760°00'00.000"	3595.12274
11	Venus	336°07'58.814"	4/11/1960	17	36.64	576°00'00.000"	6336°00'00.000"	3954.73377
12	Venus	192°07'58.814"	4/5/1961	13	56.28	576°00'00.000"	6912°00'00.000"	4313.58075
13	Venus	48°07'58.814"	4/1/1962	0	3.97	576°00'00.000"	7488°00'00.000"	4674.00275

Table 8.6

Fibonacci 13 repetitions of  $\Delta$  Venus=576° complete in 4,674 days = 667 weeks.

Axis	Planet	Longitude	Date	Hour	Minute	Change (Previous Axis)	Change (From Start)	Calendar Days
0	Earth	262°36'01.895"	6/14/1949	0	0	N/A	N/A	0
1	Earth	118°36'01.895"	1/19/1951	11	52.11	576°00'00.000"	576°00'00.000"	584.49452
2	Earth	334°36'01.895"	8/27/1952	23	27.14	576°00'00.000"	1152°00'00.000"	1170.97718
3	Earth	190°36'01.895"	3/31/1954	20	54.55	576°00'00.000"	1728°00'00.000"	1751.87122
4	Earth	46°36'01.895"	11/9/1955	19	0.16	576°00'00.000"	2304°00'00.000"	2339.79178
5	Earth	262°36'01.895"	6/13/1957	22	16.98	576°00'00.000"	2880°00'00.000"	2921.92846
6	Earth	118°36'01.895"	1/19/1959	10	19.05	576°00'00.000"	3456°00'00.000"	3506.42989
7	Earth	334°36'01.895"	8/27/1960	21	58.61	576°00'00.000"	4032°00'00.000"	4092.9157
8	Earth	190°36'01.895"	3/31/1962	19	30.28	576°00'00.000"	4608°00'00.000"	4673.81269

Table 8.7

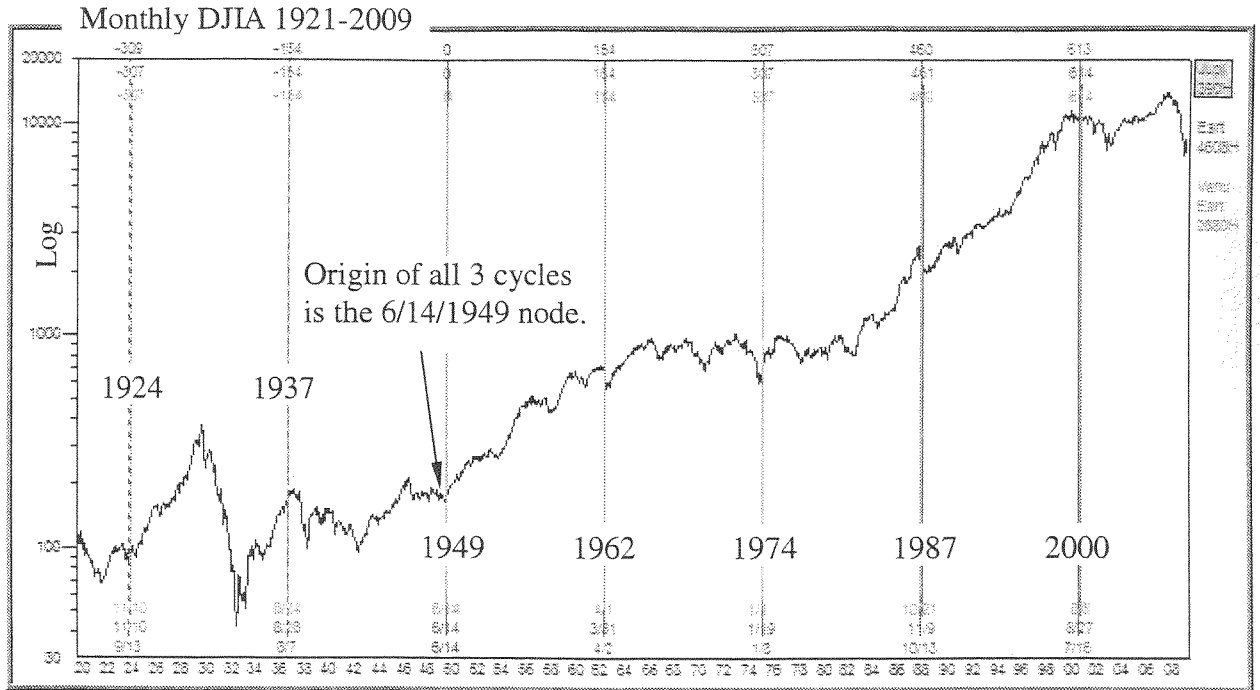
Fibonacci 8 repetitions of  $\Delta$  Earth=576° complete in 4,674 days = 667 weeks.

Axis	Planet	Longitude	Date	Synodic Angle	Change (Previous)	Change (From Start)	Calendar
0	Venus	120°07'58.814"	6/14/1949	142°28'03.081"	N/A	N/A	0
	Earth	262°36'01.895"					
1	Venus	174°01'08.945"	1/1/1952	73°31'56.919"	576°00'00.000"	576°00'00.000"	931.95439
	Earth	100°29'12.026"					
2	Venus	229°04'10.333"	7/22/1954	70°28'03.081"	576°00'00.000"	1152°00'00.000"	1864.9218
	Earth	299°32'13.414"					
3	Venus	291°51'02.413"	2/15/1957	145°31'56.919"	576°00'00.000"	1728°00'00.000"	2803.26566
	Earth	146°19'05.494"					
4	Venus	342°00'30.635"	9/3/1959	1°31'56.919"	576°00'00.000"	2304°00'00.000"	3733.74528
	Earth	340°28'33.716"					
5	Venus	48°37'16.078"	4/1/1962	142°28'03.081"	576°00'00.000"	2880°00'00.000"	4674.30718
	Earth	191°05'19.159"					

Table 8.8

Fibonacci 5 repetitions of  $\Delta$  Earth-Venus=576° complete in 4,674 days = 667 weeks.





**Chart 8.8**

Three astro cycles coincident with the 13-year stock market cycle.  
 $\Delta$  Earth-Venus=2,880<sup>0</sup>,  $\Delta$  Earth=4,608<sup>0</sup>,  $\Delta$  Jupiter=390<sup>0</sup>.

Table 8.9 shows a simple projection of when the next nest of these cycles are due. For triangulation, two different cycle origins are used. This cycle indicates that the trader should watch for a trend reversal on the indicated dates. An up-trending market into May-July 2013 should raise caution, especially considering the expected 17-year cycle low in 2016-2017. Similarly, a down-trending market into this same time period

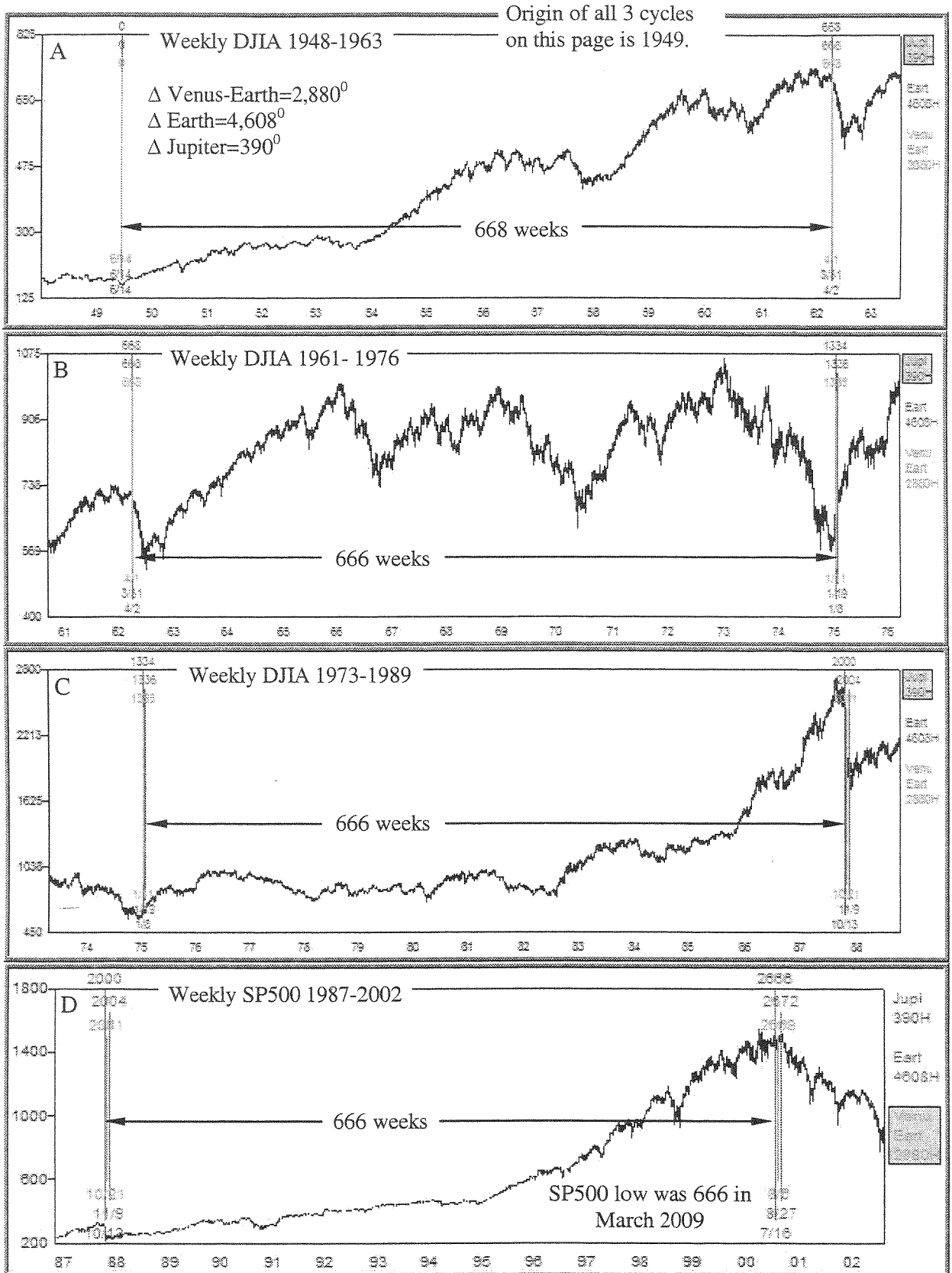
would signal a major bottom. As far as the trader is concerned it is irrelevant which condition exists. Simply knowing this is a reversal date is enough to reverse positions.

Previous chapters showed that the  $\Delta$  Uranus=18<sup>0</sup> cycle arrives in May 2012, one year before the 13-year cycle. This provides a possible anniversary date for further refining the analysis real-time.

Cycle Origin = 3/16/1962		Cycle Origin = 10/20/1987	
$\Delta$ Earth-Venus=2,880 <sup>0</sup>	5/11/2013	$\Delta$ Earth-Venus=2,880 <sup>0</sup>	5/25/2013
$\Delta$ Earth=4,608 <sup>0</sup>	5/28/2013	$\Delta$ Earth=4,608 <sup>0</sup>	5/23/2013
$\Delta$ Jupiter=390 <sup>0</sup>	4/12/2013	$\Delta$ Jupiter=390 <sup>0</sup>	5/7/2013
$\Delta$ Earth-Mars=2,160 <sup>0</sup>	7/19/2013	$\Delta$ Earth-Mars=2,160 <sup>0</sup>	7/1/2013

**Table 8.9**

The 13-year "Mark of the Beast" cycle projections to 2013



**Chart 8.9**

Three 13-year astro cycles in weekly DJIA and SP500, cycle origin is 1949.

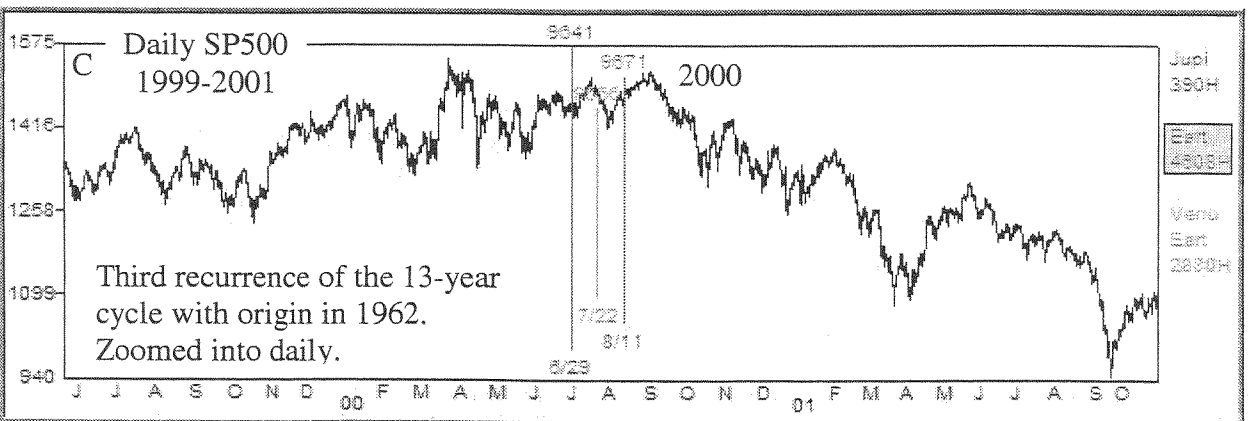
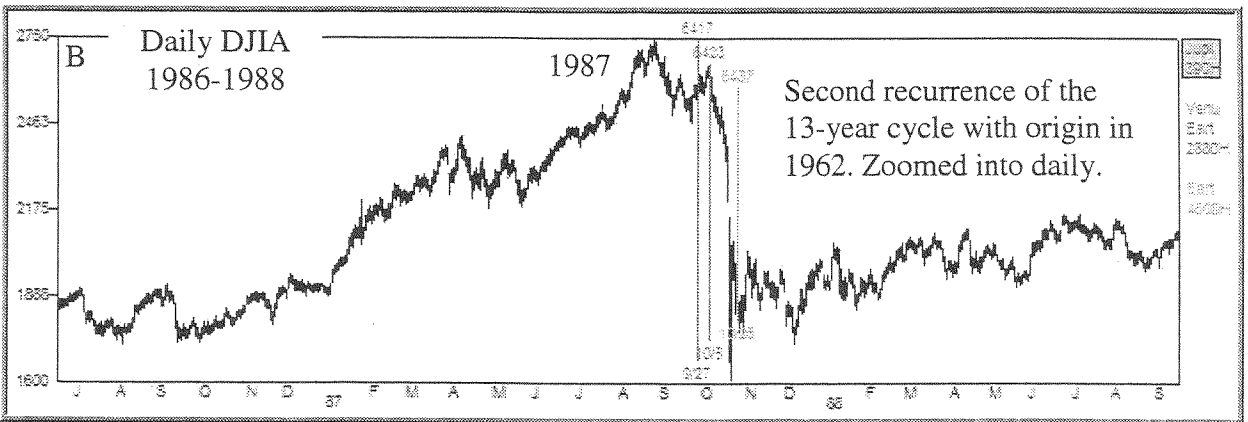
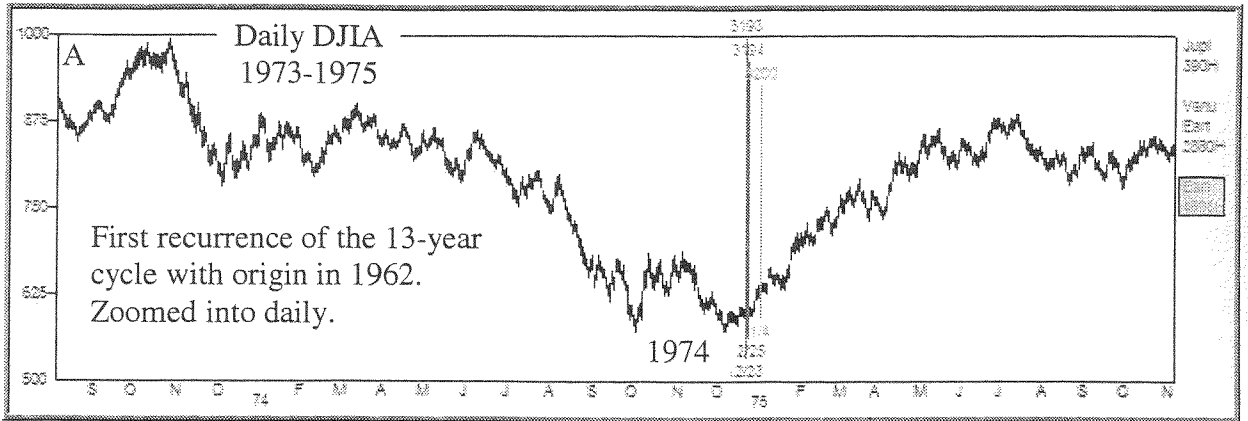


Chart 8.10

13-year cycles on daily charts with their origin set at first recurrence in 3/16/1962.

**FIBONACCI PARTITIONING 13-YEAR CYCLE INTO 8 AND 5 YEARS**

The 13-year cycle corresponds with five recurrences of the 4<sup>th</sup> Square of Twelve in the Earth-Venus cycle,  $\Delta \text{Earth-Venus}=576^0$ . Using other Fibonacci multiples of the  $576^0$  cycle subdivides the 13-year cycle into the 8 and 5-year cycles.

Fibonacci multiples of  $\Delta \text{Earth-Venus}=576^0$  are,

- $\Delta \text{Earth-Venus}=576^0 \times 2 = 5 \text{ years}$
- $\Delta \text{Earth-Venus}=576^0 \times 3 = 8 \text{ years}$
- $\Delta \text{Earth-Venus}=576^0 \times 5 = 13 \text{ years}$

These 5 and 8-year components of the 13-year cycle divide it into a 5-3-5 yearly pattern. There are 5 years up, followed by 2½ to 3 years down, ending with another 5-years up.

The 5-3-5 pattern is well known among Elliott Wave analysts. Elliott uses price segments advancing in five sections, declining in three, then another five-section advance.

These 5 and 8-year components of the 13-year cycle are integral multiples of the  $\Delta \text{Earth-Venus}=576^0$  cycle in a 2-1-2 pattern. That is,

- $\Delta \text{Earth-Venus}=576^0 \times 2 = 5 \text{ years up}$
- $\Delta \text{Earth-Venus}=576^0 \times 1 = 2\frac{1}{2} \text{ years down}$
- $\Delta \text{Earth-Venus}=576^0 \times 2 = 5 \text{ years up}$

Gann mentioned the 2-1-2 pattern in his Master Courses as a subdivision of the 5-year cycle.

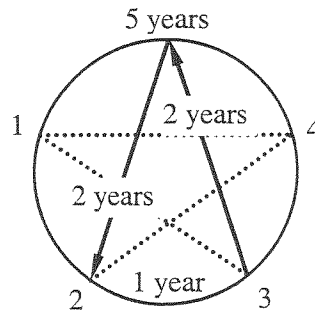
*"A bull campaign generally runs 5 years – 2 years up, 1 year down, and 2 years up, completing a 5-year cycle." ...*

*"The smallest complete cycle or work-out in the market is 5 years."*

Forecasting, 1935

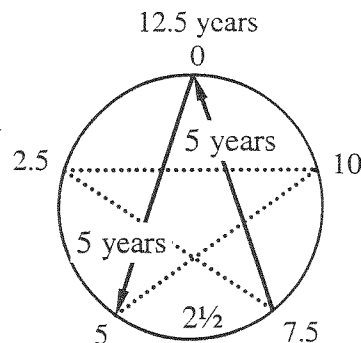
The 2-1-2 components of the 5-year cycle match the pentagonal model consisting of Golden Triangles. The equal legs of the triangle are two years and the base is one year, creating a 2-1-2 pattern.

- $\Delta \text{Earth}=360^0 \times 2 = 2 \text{ years up}$
- $\Delta \text{Earth}=360^0 \times 1 = 1 \text{ years down}$
- $\Delta \text{Earth}=360^0 \times 2 = 2 \text{ years up}$



**Figure 8.11**  
Golden Triangle and the 2-1-2 pattern of the 5-year cycle.

The same principle Gann used to subdivide the 5-year cycle into 2-1-2 years is used to subdivide the 13-year cycle into 5-3-5 years. Gann used  $360^0$  movements of Earth (one year) as his cycle gnomon. The unit of measurement in the 13-year cycle is  $576^0$  movements of Earth-Venus (2½ years). The 5-year components are the two equal triangle legs. The 2½-year bear segment is the small leg.



**Figure 8.12**  
Golden Triangle and the 2-1-2 pattern of the 13-year cycle.

Figures 8.11 and 8.12 show another example of the wheels-within-wheels nature of the cosmos. The complete 5-year Earth pentagram in Figure 8.11 defines one segment, or one leg, of the 12.5-year Golden Triangle in Figure 8.12.

Chart 8.11 plots  $\Delta$  Earth-Venus= $576^0$  on three 13-year cycles, 1994-2007, 1974-1987 and 1924-1937. In each instance it can be seen that the second multiple of  $576^0$  coincided with the first 5-year cycle, the third multiple coincided with the 8-year cycle, and the fifth multiple of  $576^0$  completed the 13-year cycle.

### **GANN'S 5-YEAR 2-1-2 PATTERN**

Rarely will you see the market move either up or down much more than five years without a significant reversal. Figure 8.2 shows that this can often be explained by the interaction of the 17 and 13-year cycles. A 5-year cycle unfolds between the time one of these larger cycles has completed and the other has not. For example, the 17-year cycle ended in 1982 and the 13-year cycle ended in 1987, a difference of five years. Other examples are 1932-1937, and 1909-1914.

A complete 5-year cycle usually aligns with the beginning, middle, or end of a 17-year cycle. Eight clear examples of 5-year cycles between 1909-2007 are listed below.

- 1909-1914 - Bear, ended at the end of a 17-year cycle (1914).
- 1924-1929 - Bull, began at a mid-cycle bottom (1924).
- 1932-1937 - Bull, began at the start of a 17-year cycle (1932).

- 1937-1942 - Bear, ended at a 17-year mid-cycle (1942).
- 1966-1970 - Bear, began at the start of a 17-year cycle (1966).
- 1982-1987 - Bull, began at the start of a 17-year cycle (1982).
- 1994-2000 - Bull, ended at the end of a 17-year cycle (2000).
- 2002-2007 - Bull, ended at a 17-year mid-cycle (2007).

Charts 8.12 and 8.13 show how well two recurrences of  $\Delta$  Earth-Venus= $576^0$  ( $576^0 \times 2 = 1,152^0$ ) timed the duration of 5-year cycles in both the bull and bear phases.

Chart 8.14 shows four 5-year bear cycles overlaid with Gann's 2-1-2 pattern. The pattern fits relatively well. At times there are inversions where a top became a bottom and vice versa.

Chart 8.15 shows five instances of the 5-year cycle in a bull phase. The duration and internal timing of these cycles are all very similar. In this case Gann's 2-1-2 pattern becomes two years up, one down, two up. Again, there are inversions where a top should have been a bottom, especially at the 2-year location. 1926, 1934, 1984, and 2004 should have been tops according to the ideal two years up pattern, but they were bottoms.

13-year cycles divided into 5-3-5 year pattern by 2, 3, 5  
 Fibonacci multiples of the  $\Delta$  Earth-Venus= $576^0$  cycle

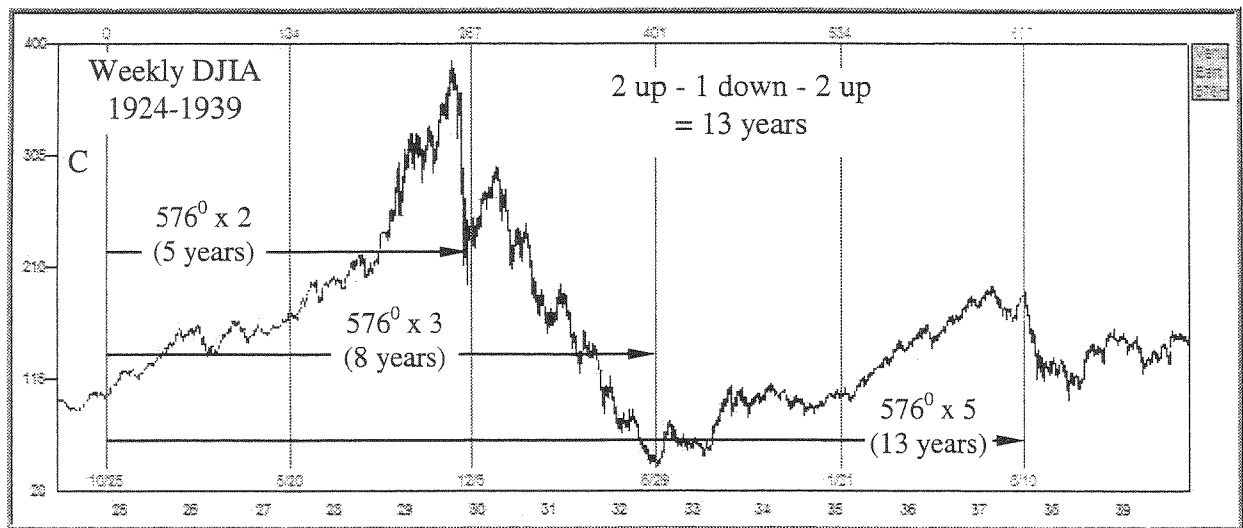
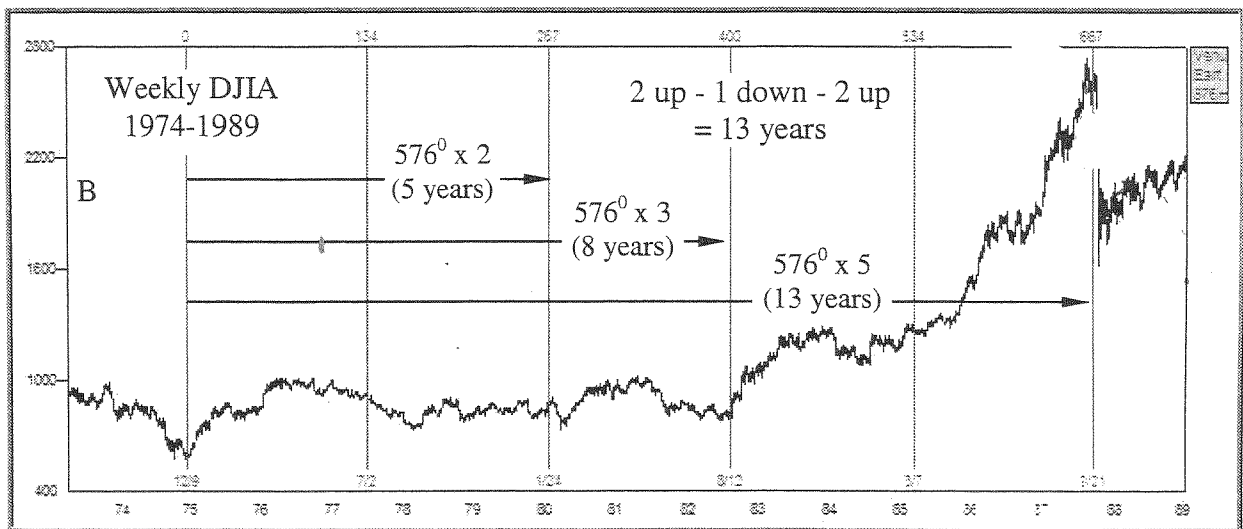
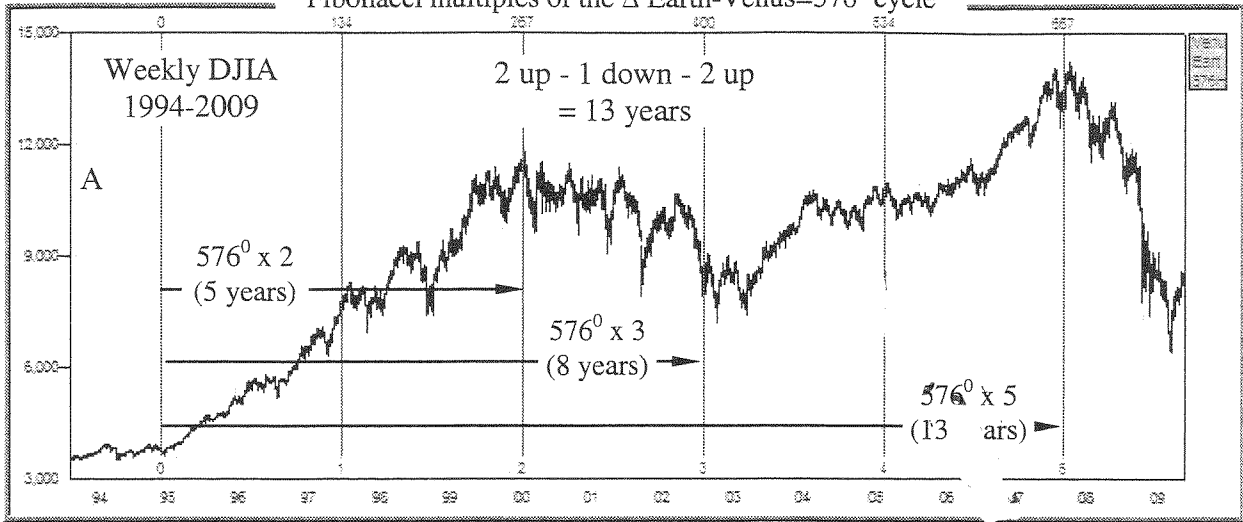


Chart 8.11

Fibonacci 2, 3, 5 recurrences of  $\Delta$  Earth-Venus= $576^0$  define a 5-3-5 year market pattern.

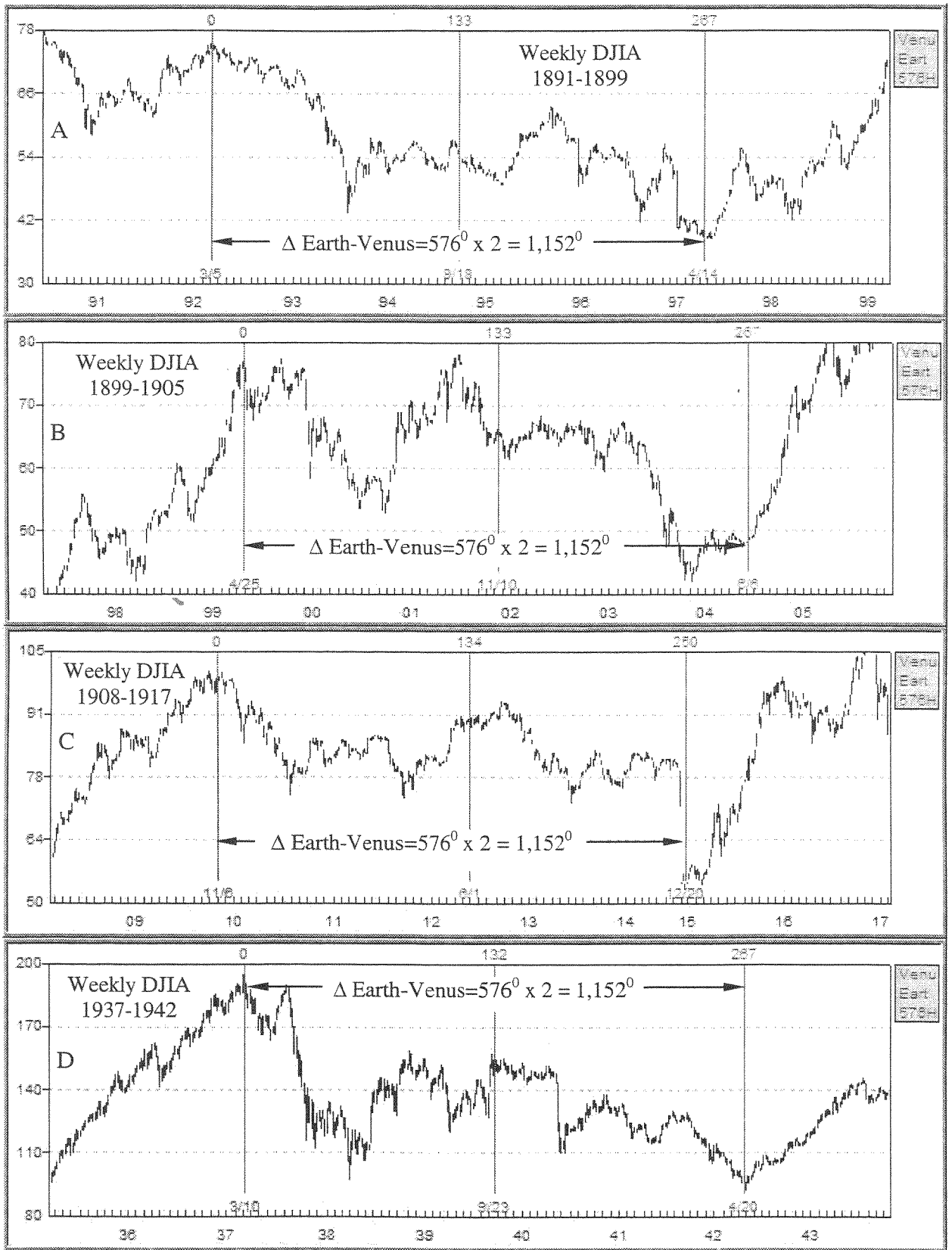
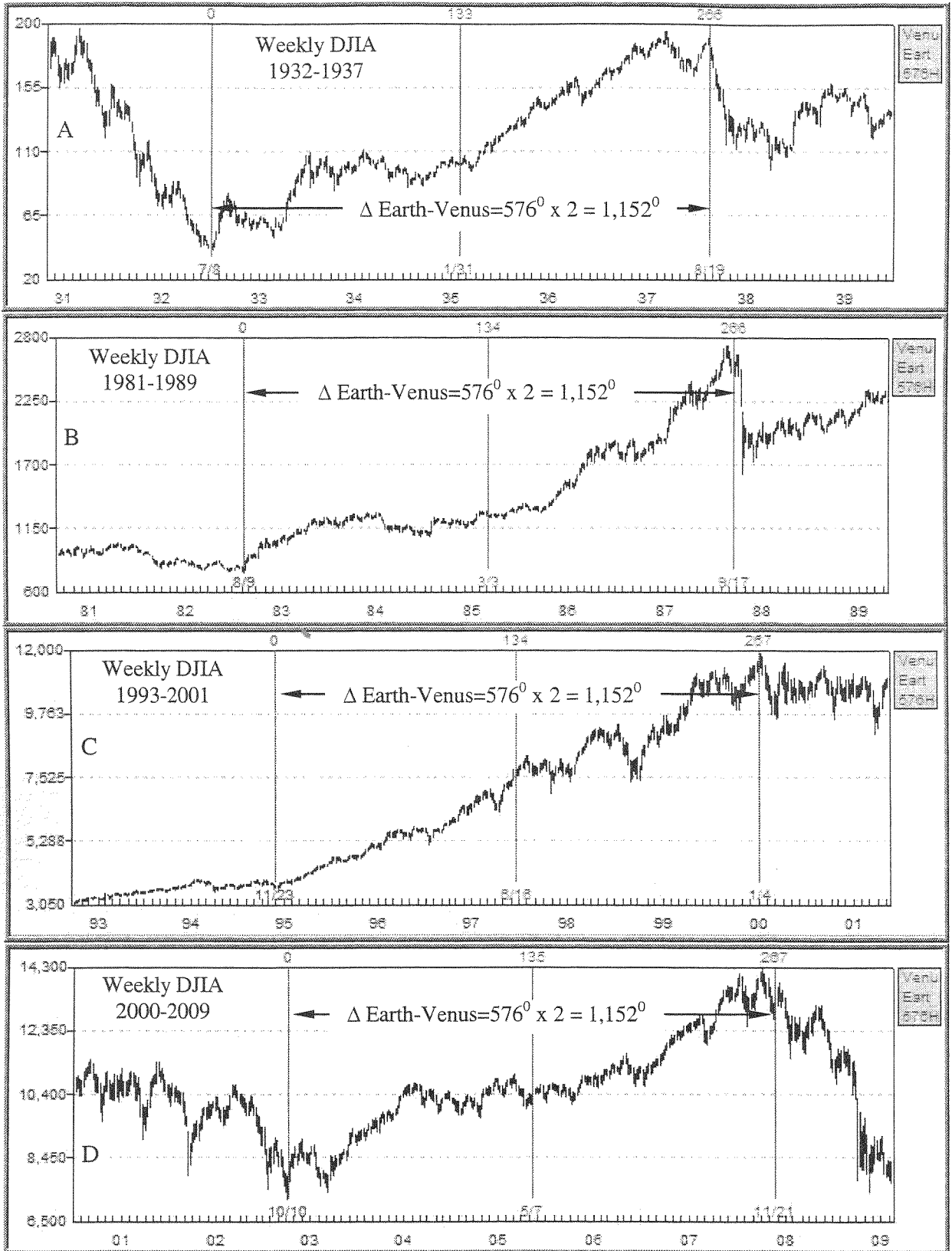


Chart 8.12

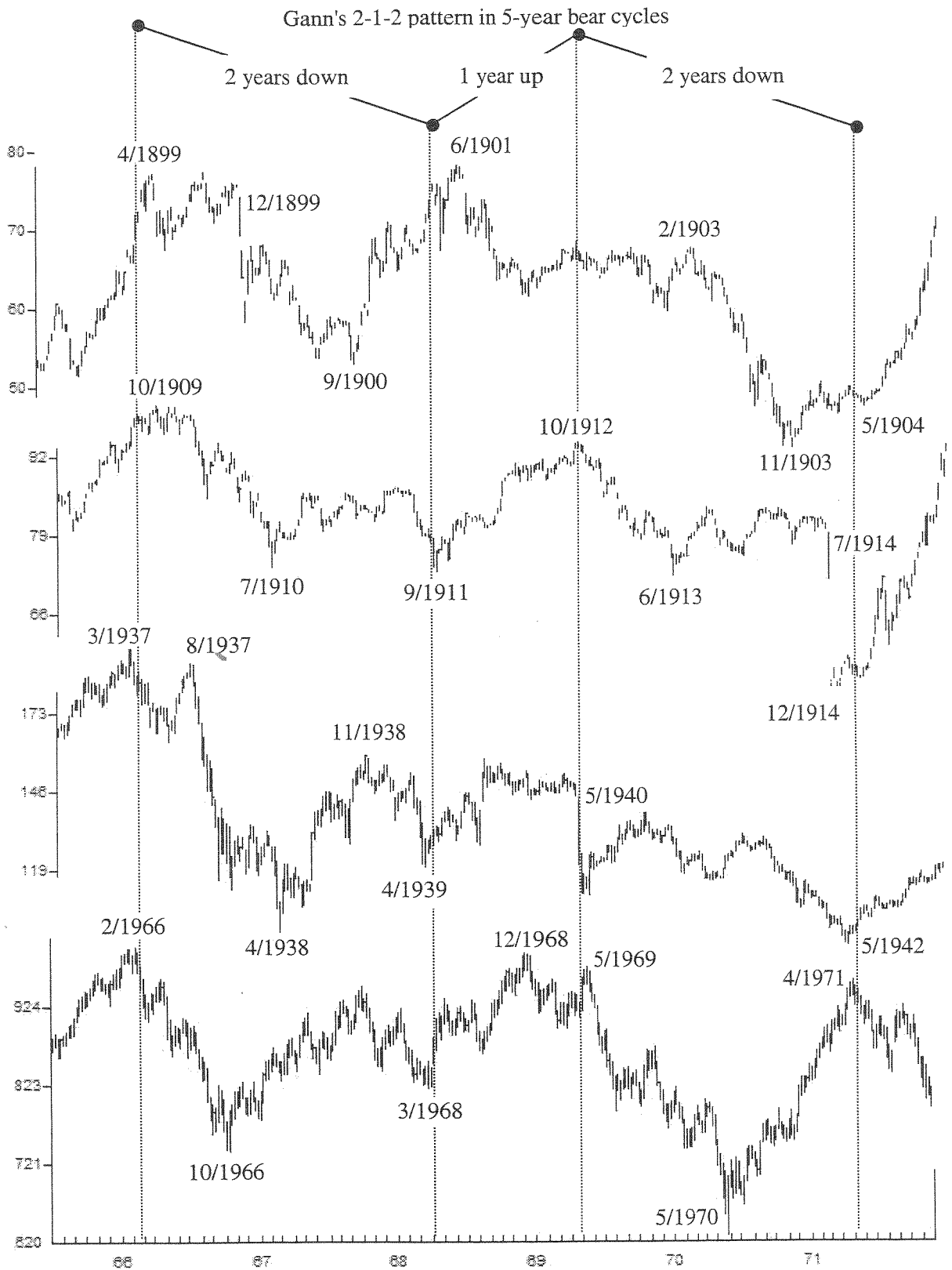
Duration of five-year bear cycles timed by  $\Delta \text{Earth-Venus} = 576^\circ \times 2 = 1,152^\circ$ .



**Chart 8.13**

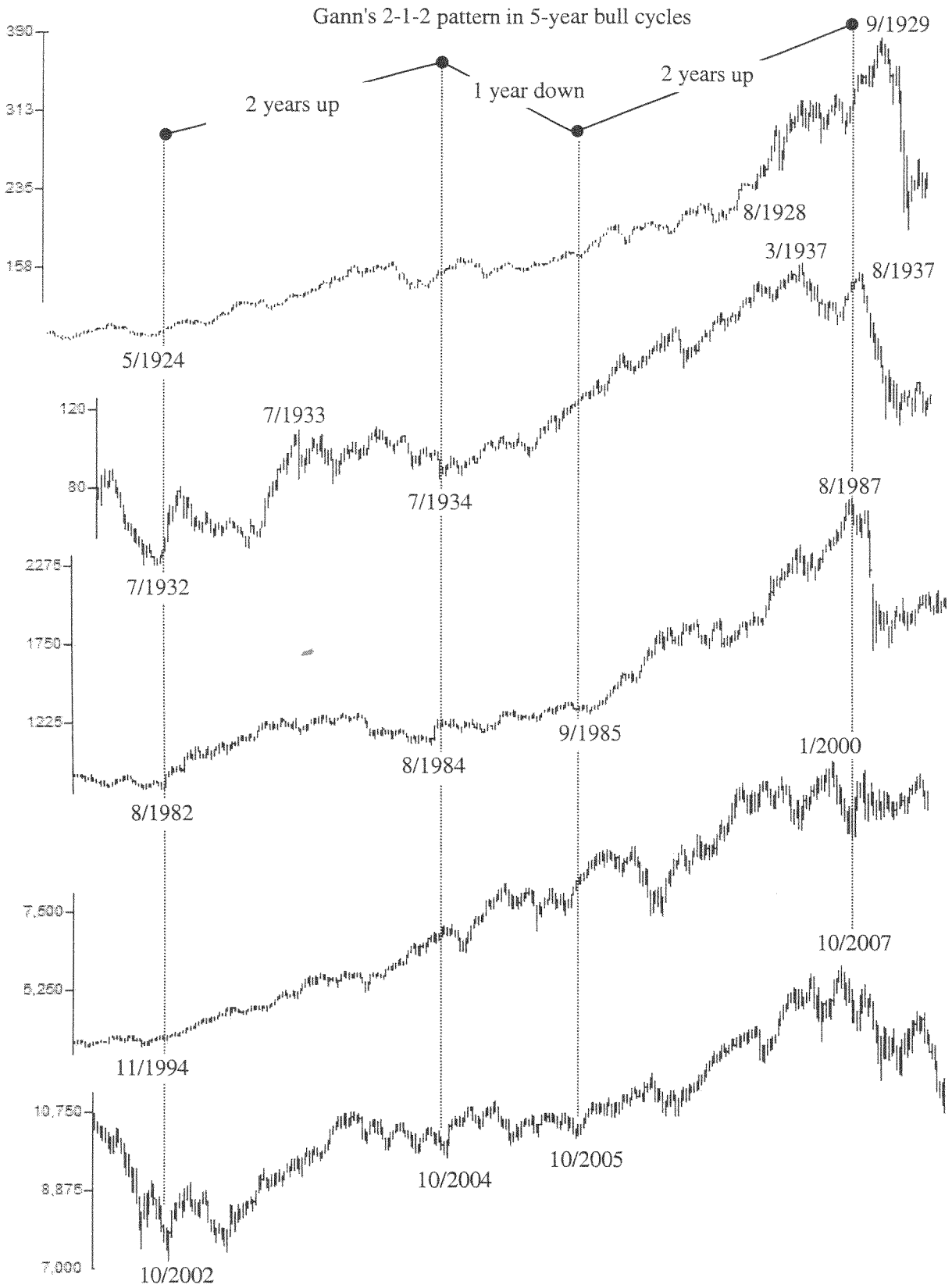
Duration of five-year bull cycles timed by  $\Delta \text{Earth-Venus} = 576^\circ \times 2 = 1,152^\circ$ .





**Chart 8.14**

Five-year cycles in a bear phase showing Gann's 2-1-2 pattern, monthly DJIA.



**Chart 8.15**

Five-year cycles in a bull phase with Gann's 2-1-2 pattern, monthly DJIA.

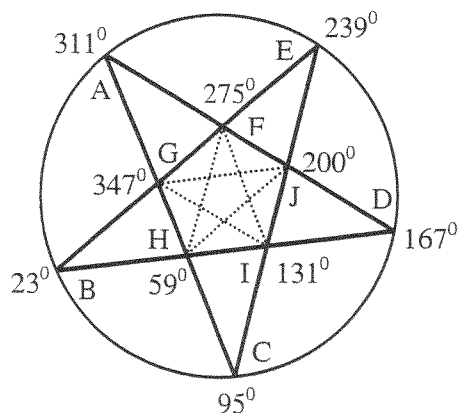
Markets are a reflection of the ongoing battle between good and evil. When the balance of power favors the dark side markets tremble and panic with widespread disruption and fear. Evil cannot maintain its grip for long and good ultimately wins the battle when markets recover from panic and continue along their path of natural growth.<sup>26</sup>

The ancient Hebrew writers of the Bible were master astrologers and undoubtedly aware of the cyclicity of panics. Living with the Chaldeans in ancient Babylonia for many years, St. John brought this base of knowledge with him when he warned in the Book of Revelation to beware the number of the Beast, 666.

Every ~666 weeks the inner planets Venus, Earth, and Mars, align on the same five sensitive points of the Great Pentagram that define the Uranus 17-year cycle. Historically this down-pointing pentagram has been used as a symbol of the Beast, the evil one. If the reader's religious beliefs make him feel uncomfortable with this orientation he can set  $0^{\circ}$  on the right side of the zodiac as many astrologers do. This will flip the pentagram upside down.

Whatever correlation the reader wishes to make with good, evil, panics, the Bible, etc, he must be aware that the 666-week cycle manifests in markets and will again cause panic and disruption.

<sup>26</sup> The long-term natural growth equation for the stock market was derived in *Four-Dimensional Stock Market Structures And Cycles*. It is updated in Appendix E.



**Figure 9.1**  
The Great Pentagram

As each planet crosses a sensitive point on the pentagram a cycle changes direction until the net effect is strong down (1962, 1987, 2000) or strong up (1949 and 1975). Chart 9.2 shows one example of cycles turning in succession on a daily chart with an ever-increasing acceleration of trend.

When planets cross sensitive points close together the trend abruptly changes. 1932-1933 provides one good example of this when Saturn and Uranus successively crossed the pentagram creating a sharp drop into a narrow double-bottom, followed by a massive rally.

When these same two planets crossed the pentagram years apart, such as 1966 and 1968, a large double top is formed. The same principle applies to the faster moving inner planets.

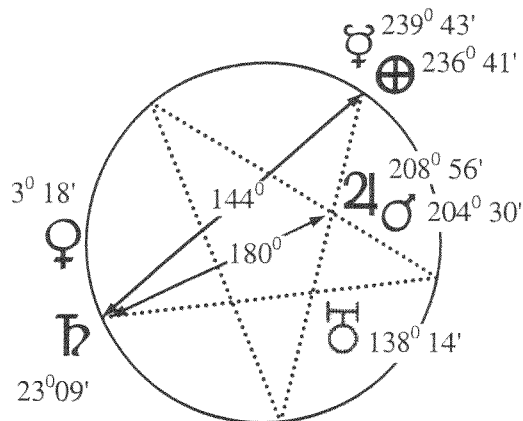
### BIRTH OF THE NYSE AT THE BUTTONWOOD AGREEMENT

The birth of the New York Stock Exchange was the signing of the Buttonwood Agreement on May 17, 1792. At this time Earth was in conjunction with Mercury at  $237^{\circ}$ , Saturn was at  $23^{\circ}$ ,  $144^{\circ}$  from the Earth-Mercury conjunction. These are two of the five locations on the stock market Great Pentagram.

In addition, Mars and Jupiter were in conjunction,  $180^{\circ}$  from Saturn, placing them on the inner pentagram. For the next 200+ years Mars-Jupiter conjunctions often triggered turns of the major cycles, such as the March 6, 2009 bottom.

Uranus at  $138^{\circ}$  was near the inner pentagram,  $70^{\circ}$  from the Mars-Jupiter conjunction.

The Earth's location at  $237^{\circ}$  explains why May 17-20 is often a major stock market turning point. Every year Earth crosses the five pentagram points on the same dates, shown in Table 9.1. Earth also crosses the  $23^{\circ}$  location of Saturn every October 19<sup>th</sup> which often triggers a major panic.



**Figure 9.2**

Buttonwood Agreement, May 17, 1792

The roles of cause and effect are unclear whenever working with planetary cycles. Is the pentagram location fixed at the time of birth? Or, is the pentagram already a dominant influence existing long before the birth, and the birth simply synchronized with it. This question is academic for the purpose of studying market cycles. All that is needed to know is that these planetary locations at the birth identified the location of the Great Pentagram and defined the five major sensitive points in the zodiac, and the five minor points of the inner pentagram.

Axis	Planet	Longitude	Date	Hour	Minute	Change	Change (From Start)	Calendar Days
0	Earth	236°41'19.646"	5/17/1792	0	0	N/A	N/A	0
1	Earth	308°41'19.646"	7/31/1792	8	27.5	72°00'00.000"	72°00'00.000"	75.35243
2	Earth	20°41'19.646"	10/13/1792	8	20	72°00'00.000"	144°00'00.000"	149.34722
3	Earth	92°41'19.646"	12/23/1792	16	53.53	72°00'00.000"	216°00'00.000"	220.70384
4	Earth	164°41'19.646"	3/4/1793	18	22.38	72°00'00.000"	288°00'00.000"	291.76554
5	Earth	236°41'19.646"	5/17/1793	5	49.09	72°00'00.000"	360°00'00.000"	365.24242

**Table 9.1**

Dates that Earth arrives at the five Great Pentagram points each year.

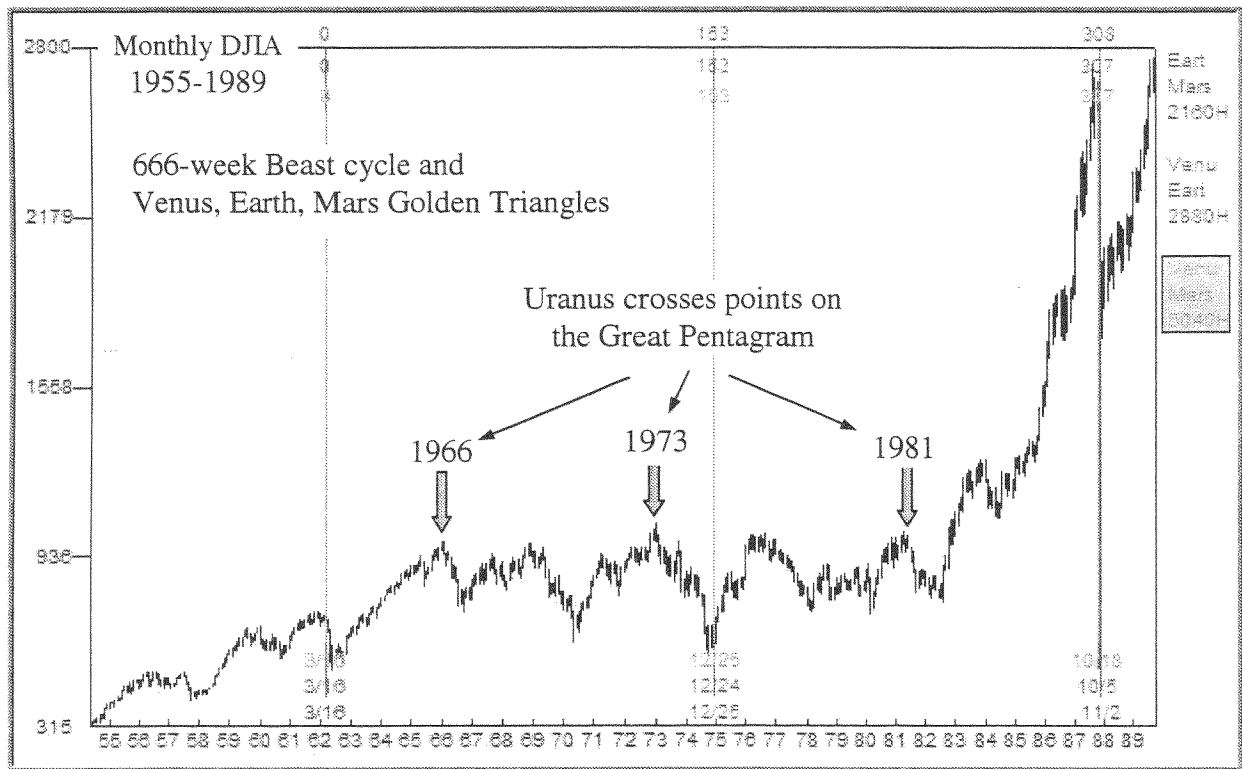
**ADDING MARS TO THE 666-WEEK BEAST CYCLE**

Earth and Venus have been shown to align very well with the 666-week cycle every 2,880<sup>0</sup>, or 20 Squares of Twelve. The timing of this cycle is greatly refined when Mars is added to the system of rotating wheels. Every 2,160<sup>0</sup>, or 15 Squares of Twelve, Earth-Mars aligns with 20 Earth-Venus Squares of Twelve. This alignment occurs every 666-667 weeks, or 12.8 years.

Chart 9.1 plots the three combinations of Venus, Earth, and Mars aligned with the Beast cycle. The strength of this disruptive cycle comes from the orientation of the planets into a Golden Triangle, 144<sup>0</sup>, 144<sup>0</sup>, 72<sup>0</sup>, and the placing of this triangle on the same pentagram defining the 17-year Uranus cycle. This is a very important

concept that proves the five sensitive points in the zodiac defining the Uranus Great Pentagram also resonate with the other planets, providing a valuable timing tool for smaller cycles.

Chart 9.1 shows that most of the major panics between 1962 and 1987 are identified by the Great Pentagram. The panics of 1966 and 1981 occurred on the 17-year cycle when Uranus touched the sensitive points. 1973 was the Uranus mid-cycle panic, 180<sup>0</sup> from 1932. Earth, Venus, and Mars aligned into Golden Triangles on the Great Pentagram in 1962, 1974, and 1987.



**Chart 9.1**

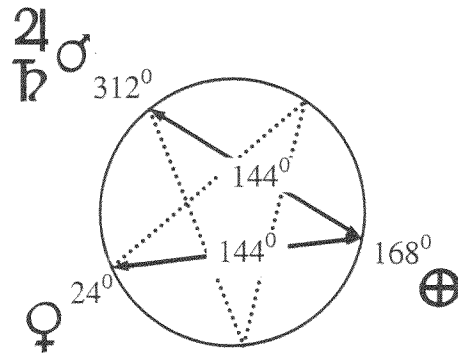
Three recurrences of the 666-week Beast cycle aligned with Earth, Venus, Mars.

**THE CAUSE OF THE CRASH OF 1962**

1961-1962 produced a flat top as the smart money distributed their stocks to the public. Jupiter terminated the bull market in November 1961 when it crossed the Great Pentagram point at  $312^{\circ}$ . Because the Venus, Earth, Mars trio had not yet arrived at the pentagram, prices mostly moved sideways with a gentle down slope.

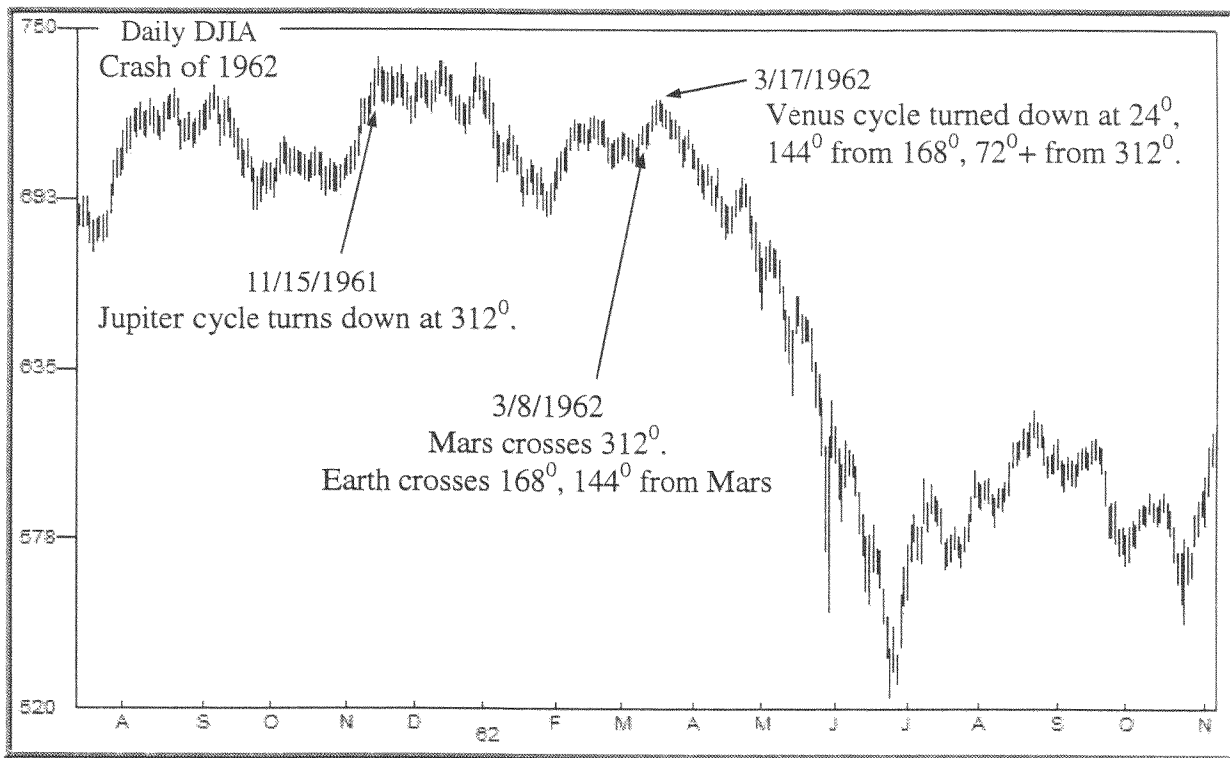
March 1962 saw this terrible-trio simultaneously align into their Golden Triangle on the Great Pentagram. Prices could no longer hold up and a 3-month panic ensued dropping prices 28% in the largest panic since World War II, twenty years earlier.

As with the March 2009 bottom, Mars conjoined with Jupiter on March 26<sup>th</sup>, 1962, just a few days from the top and ensuing



**Figure 9.3**  
Golden Triangle at the crash of 3/1962.

panic. Mars had conjoined with Saturn at  $303^{\circ}$  one month earlier, placing all these planets on the Great Pentagram with Earth, Venus, and Mars in Golden Triangle formation.

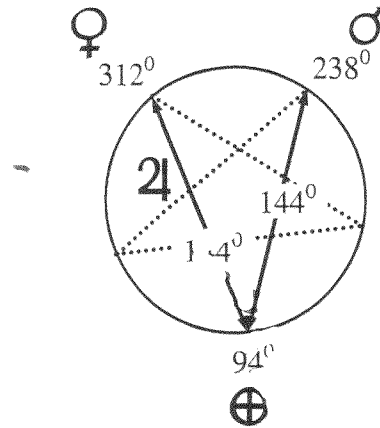


**Chart 9.2**  
Great Pentagram cycles at the crash of 1962.

**THE CAUSE OF THE CRASH OF 1974**

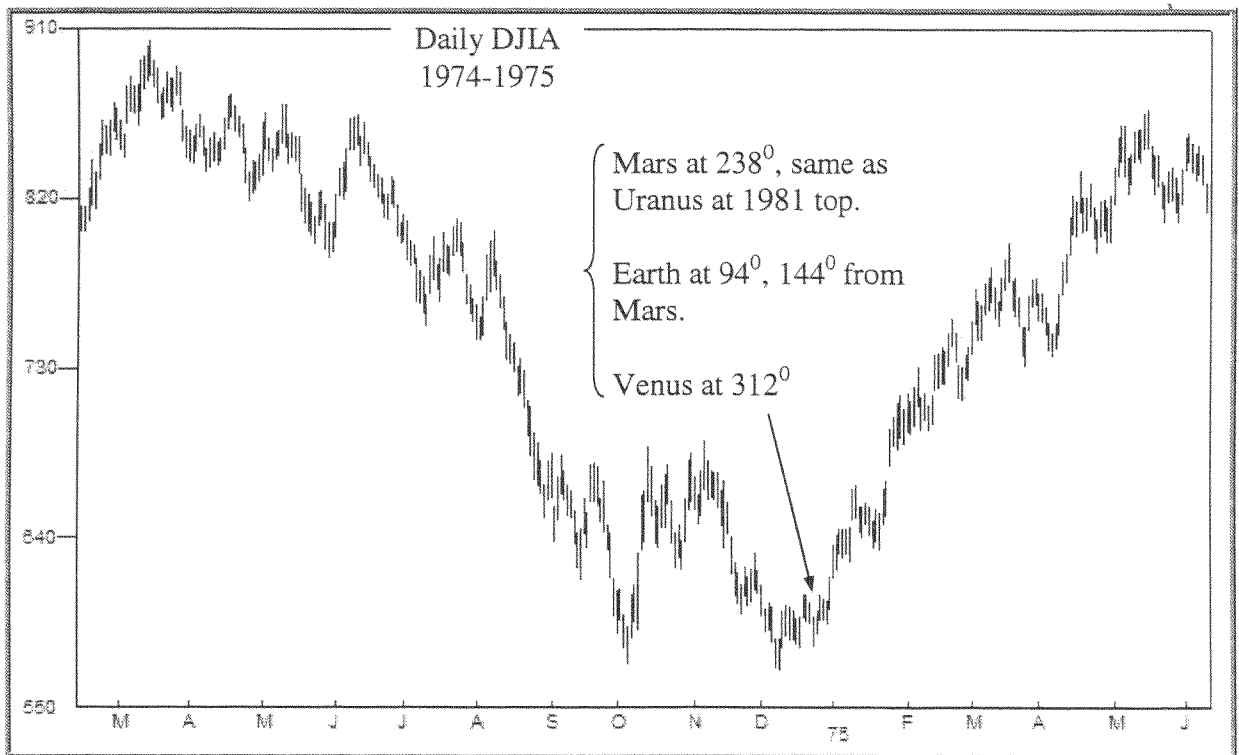
1973-1975 was not a pleasant time in markets or around the world. The Arab oil embargo of 1973 triggered an economic disruption that rippled throughout the world. The United States was withdrawing from Vietnam subjecting millions of people to communist rule leading to the genocide in Cambodia and wholesale slaughter and subjugation of many South Vietnamese at the hands of the communists.

The stock market began its decline in January 1973 when Uranus touched the inner pentagram at  $200^{\circ}$ , which was the mid-cycle top  $180^{\circ}$  from the 1932 depression low. Prices continued their decline until the 666-week Beast reached its nadir in December 1974.



**Figure 9.4**  
Golden Triangle at the 12/1974 bottom.

Venus, Earth, and Mars were again arranged in the same  $144^{\circ}$ - $144^{\circ}$ - $72^{\circ}$  Golden Triangle on the Great Pentagram. This triangle was rotated  $72^{\circ}$  from the 1962 triangle.

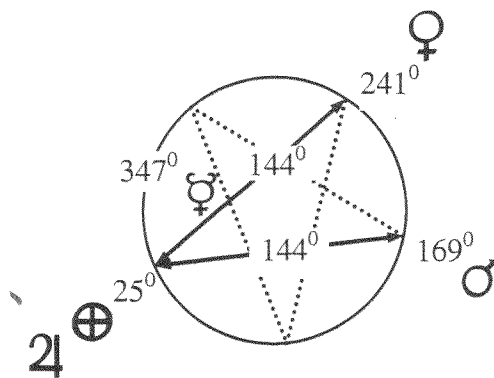


**Chart 9.3**  
Golden Triangle cycles at the crash bottom of 12/1974. Rotated  $72^{\circ}$  from 1962.

**THE CAUSE OF THE CRASH OF 1987**

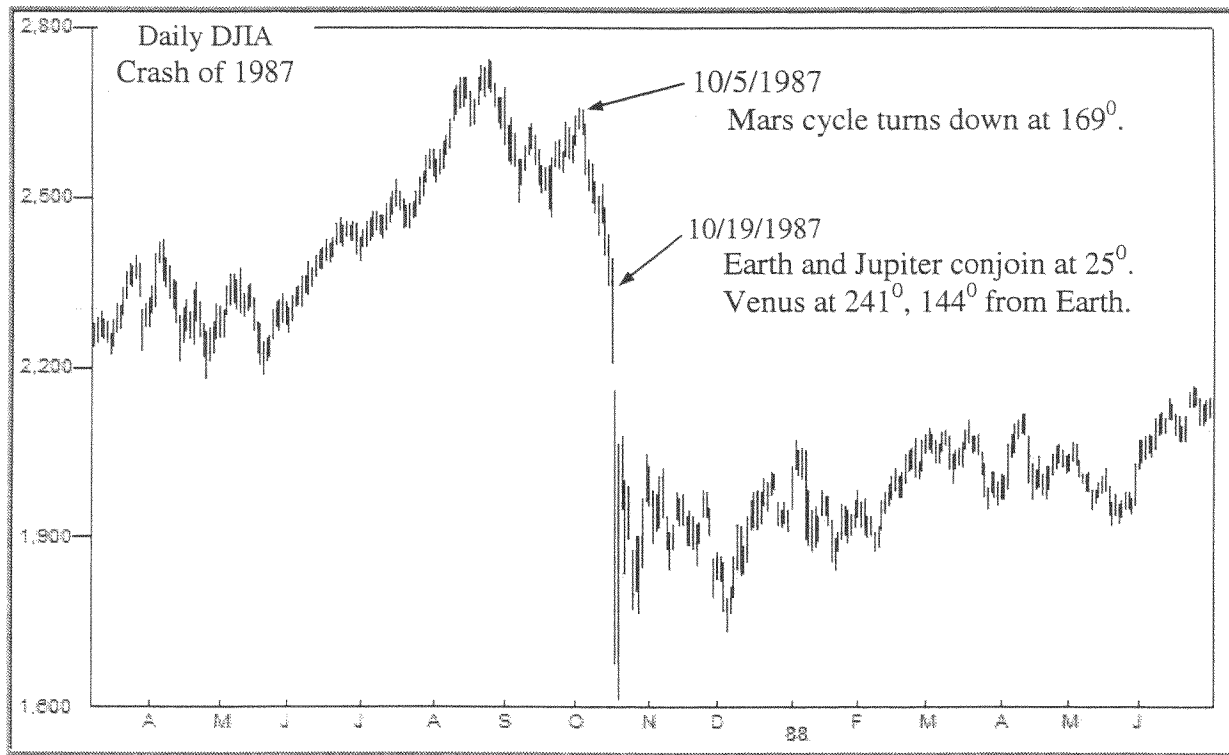
The crash of 1987 has been shown to align with the Saturn cycle in two ways. Chart 7.22 showed the  $\Delta$  Saturn= $36^\circ$  cycle from the 1981 Uranus axis arrived in 10/1987, as did the  $\Delta$  Saturn= $60^\circ$  cycle from 1982.

The 13-year cycle also arrived at this time. On October 5<sup>th</sup> Mars was the first planet in the Golden Triangle to arrive at one of the five Great Pentagram sensitive points at  $169^\circ$ . Prices immediately began to decline. When October 19<sup>th</sup> arrived three other planets, Venus, Earth, and Jupiter, aligned with two other sensitive points. Prices collapsed in a panic that had not been seen since 1929, with prices dropping at least 25% in two days. The panic was so bad that a vacuum occurred under the market. There were no bids to absorb the massive sell orders and trading in many stocks was



**Figure 9.5**  
Golden Triangle at the crash of 10/1987.

stopped. The intraday quote of 1616 for the 30-stock DJIA is fallacious because it only included the five stocks remaining open at the time. This number would have undoubtedly been much lower if the other 25 stocks were open for trading.



**Chart 9.4**  
Golden Triangle cycles at the crash of October 1987. Rotated  $72^\circ$  from 1974.



TRIPLE TRIANGLE OF 1962, 1974, 1987

The three Golden Triangles of 1962, 1974, and 1987 are each situated at points on the same Great Pentagram defining the 17-year Uranus cycle. These triangles are each separated by 666-weeks and are rotated 72° clockwise from the preceding triangle.

Chart 9.1 shows that these three cycles are the ones that did not start at the 17-year cycles in 1949, 1966, 1982, and 2000. The 13 and 17-year cycles come together every Jubilee period of 50-51 years, such as in

1949 and 2000. When looking for the Golden Triangle at these common nodal points it is important to consider the interaction of the Uranus and Saturn cycles arriving at the pentagram near this time.

When all three of the Golden Triangles are overlaid, they produce the Triple Triangle or Great Pentagram shown in Figure 9.6.D.

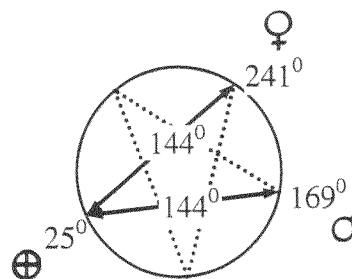
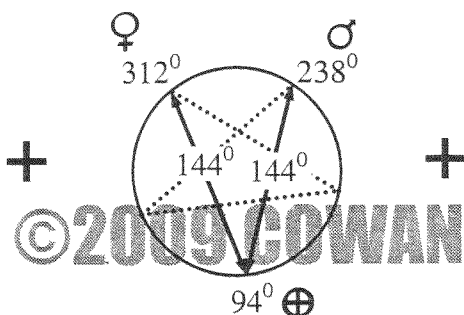
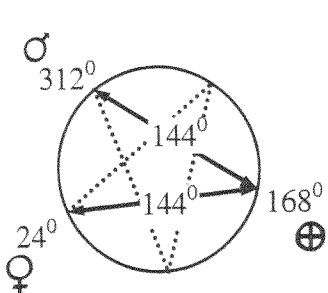


Figure 9.6.A  
3/1962 Golden Triangle

Figure 9.6.B  
12/1974 Golden Triangle

Figure 9.6.C  
10/1987 Golden Triangle

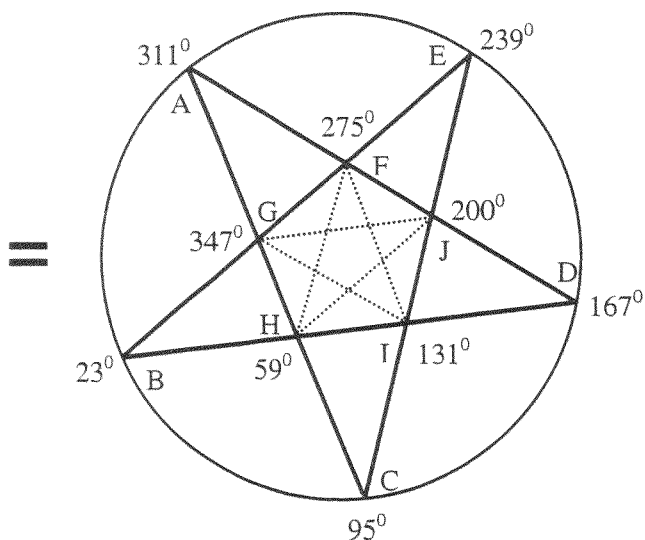


Figure 9.6.D  
The Beast Triple Triangle

Notice that the three Golden Triangles shown above are the same. Venus and Mars are at the base separated by 72° and Earth is at the apex. Each triangle is rotated 72° clockwise to arrive at the next 666-week cycle.

It is vitally important for the reader to reproduce the calculations from this book on his own charts. There is no substitute for spending a few hours studying these cycles on the pentagram. This book serves as a general guidance tool to show the reader where to look for the cycles and how to do it.

### THE MATHEMATICAL BASIS OF THE 666-WEEK BEAST CYCLE

If the planets orbited in simple integral multiples it would be easy to calculate when they would return to their Golden Triangle patterns. However, the arrangement of the solar system is not that simple because the periods of the planets are in non-integral ratios. Measured in Earth years they are,

Venus/Earth	= 0.62
Earth	= 1
Mars/Earth	= 1.88
Ceres/Earth	= 4.60

Ceres is included because it fits into the mathematical expansion of the orbits. In 2006 Ceres was reclassified with the same designation as Pluto, a "dwarf planet". Ceres is the major body in the asteroid belt between Mars and Jupiter, accounting for 1/3 of the total mass. The debris in the asteroid belt did not all collect into a planet as did the others, but its orbital period fits the pentagonal model quite well. Ceres is the best representative of the asteroid belt.

Figure 9.6 shows that Venus-Earth-Mars returned to their Golden Triangle arrangement every 12.8 years rotated 72° clockwise from their previous location. If the orbits were in integral multiples they would return to the same arrangement without rotation.

Chart 9.5 shows where the cycles would arrive if their orbits are multiplied an integral number of times. Each cycle originates at the 3/16/1962 top and advances the number of 360° orbits that put it closest to the 12/1974 bottom. The result is that Mars and Earth are separated by 3 months and Ceres almost a year. This is not a good alignment with the 12/1974 bottom.

The planets realign on the Golden Triangle after 12.8 years in integral multiples of 144°, not 360°. The 0.2 year difference between 13 years and 12.8 accounts for the 72° of rotation of the Golden Triangle between recurrences because Earth moves 72° in 0.2 year.

$$360^{\circ} \times 0.2 = 72^{\circ}$$

Table 9.2 shows the displacement of the same four planets that align with the 12.8-year cycle plotted in Chart 9.7. The total displacement for each planet from the 3/16/1962 top is an integral multiple of 360° plus an additional 288°. In mathematical terms this is called "mod 360". Ceres goes around the zodiac two complete circles plus an additional 288°. Mars completes 6 orbits, Earth 12, and Venus 20, all with an additional 288° to account for the 72° rotation of the Golden Triangle to the next location on the pentagram.

Modular arithmetic is also called clock arithmetic. A clock counts up to 12 then starts over again at zero. When the clock is at 1 it is not 13 o'clock because the complete circle of 12 hours is removed and only the remainder used. A circle of 360° in the zodiac works the same way. When a planet moves 648° it is at 288° because the circle of 360° is removed and only the remainder of 288° used. Mathematically this is called "mod(360)".

Modular arithmetic shows the net movement of each of the planets during the 12.8-year cycle is 288°, or the second Square of Twelve.

$$\begin{aligned} 288^{\circ} &= 1,008^{\circ} \bmod (360^{\circ}) = \text{Ceres} \\ 288^{\circ} &= 2,448^{\circ} \bmod (360^{\circ}) = \text{Mars} \\ 288^{\circ} &= 4,608^{\circ} \bmod (360^{\circ}) = \text{Earth} \\ 288^{\circ} &= 7,488^{\circ} \bmod (360^{\circ}) = \text{Venus} \end{aligned}$$

	Planetary Displacement 3/1962 – 12/1974	Days
Ceres	$(360^0 \times 2) + 288^0 = 1,008^0$	4,660
Mars	$(360^0 \times 6) + 288^0 = 2,448^0$	4,655
Earth	$(360^0 \times 12) + 288^0 = 4,608^0$	4,677
Venus	$(360^0 \times 20) + 288^0 = 7,488^0$	4,673

**Table 9.2**  
Multiples of  $360^0$  during the 666-week cycle.

Table 9.2 shows the number series counting the number of complete orbits of the planets is 2, 6, 12, 20. This number series is derived from the squares of the integers.<sup>27</sup>

Integers: 1, 2, 3, 4  
Integers<sup>2</sup>: 1, 4, 9, 16  
 Sum of above: 2, 6, 12, 20

In equation form, the number of required complete orbits during the 666-week cycle is given by:

$$\text{Number of complete orbits} = (n^2 + n)$$

Where n are successive integers 1, 2, 3, 4.

$(1^2 + 1) = 2$  = Ceres  
 $(2^2 + 2) = 6$  = Mars  
 $(3^2 + 3) = 12$  = Earth  
 $(4^2 + 4) = 20$  = Venus

Inserting  $(n^2 + n)$  into the equation in Table 9.2 gives the equation for the 666-week cycle.

Planetary displacement during the 666-week cycle =

$$360^0 (n^2 + n) + 288^0$$

Where n is an integer 1, 2, 3, 4 representing Ceres, Mars, Earth, and Venus, respectively.

Table 9.2 shows the results deviate from each other by no more than 22 calendar days during the 666-week cycle. The average of the four cycles is 4,666 days = 666 weeks.

**INTEGRAL MULTIPLES OF  $144^0$   
ALIGN ORBITS WITH BEAST CYCLE**

Chart 9.6 shows that when the unit of measurement is  $144^0$  instead of  $360^0$  the four planets Ceres, Mars, Earth, and Venus align with the Beast cycle on integral multiples.

$1,008^0 / 144^0 = 7$  = Ceres  
 $2,448^0 / 144^0 = 17$  = Mars  
 $4,608^0 / 144^0 = 32$  = Earth  
 $7,488^0 / 144^0 = 52$  = Venus

The  $144^0$  based expansion produces the number series 7, 17, 32, 52. The increase between each item in the series is pentagonal as shown in Figure 9.7.

$17 - 7 = 10$  = Mars to Ceres  
 $32 - 17 = 15$  = Earth to Mars  
 $52 - 32 = 20$  = Venus to Earth  
 $52 - 17 = 35$  = Venus to Mars

This pentagonal expansion number series explains why the degrees for each synodic cycle in Chart 9.1 were chosen.

$\Delta \text{ Earth-Mars} = 2,160^0 = 144^0 \times 15$   
 $\Delta \text{ Venus-Earth} = 2,880^0 = 144^0 \times 20$   
 $\Delta \text{ Venus-Mars} = 5,040^0 = 144^0 \times 35$

<sup>27</sup> Reference, *The Theoretic Arithmetic of the Pythagoreans*, Thomas Taylor.

Chart 9.5 shows that when the planets are advanced an integral number of complete 360° orbits they do not arrive together, and not near the 666-week cycle.

However, Chart 9.6 shows that when the planets are advanced by the planetary displacement equation based on 144° they arrive together at the 666-week cycle. Chart 9.7 extends this cycle to 10/1987.

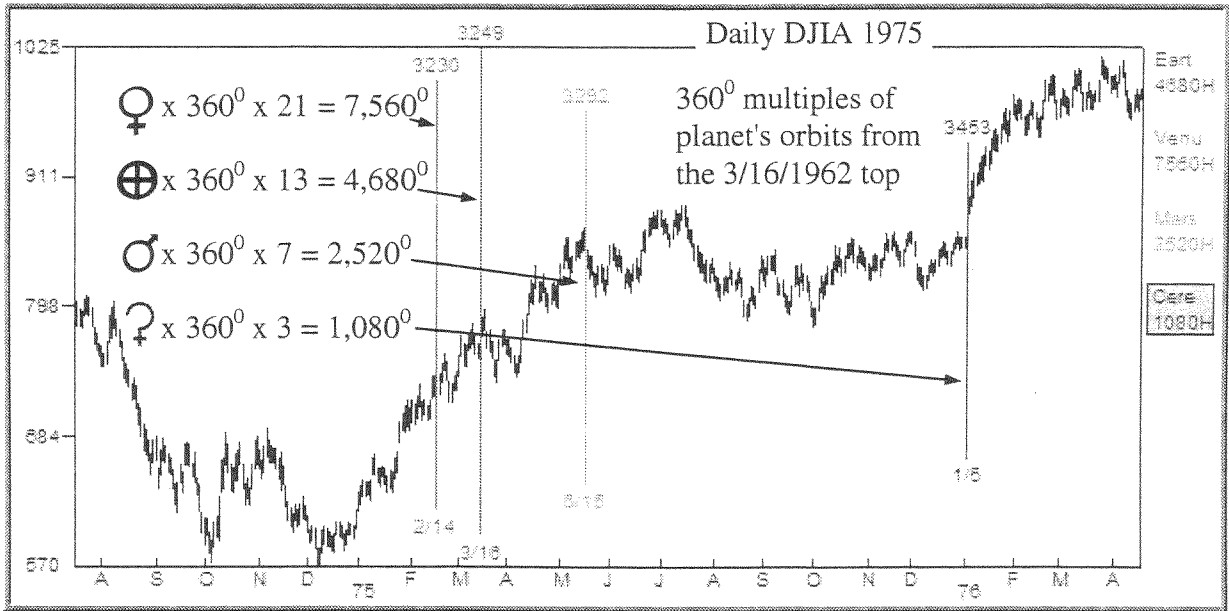


Chart 9.5

360° multiples of the orbits of four planets from the 3/16/1962 top.

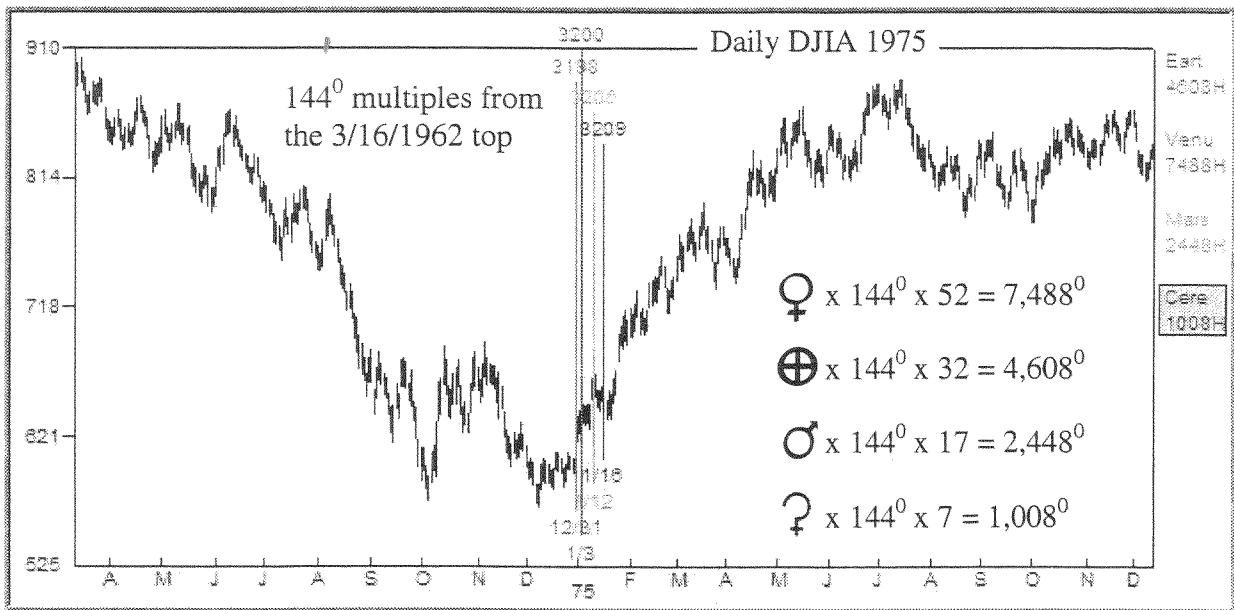


Chart 9.6

144° multiples of the orbits of four planets from the 3/16/1962 top.

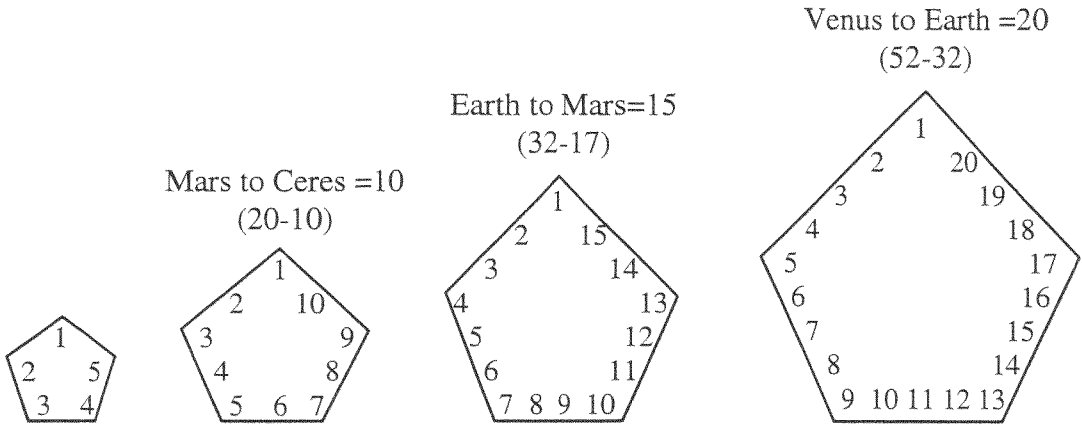


Figure 9.7

Pentagonal expansion of planetary displacement during Beast cycle. Multiples of 144<sup>0</sup>.

**WWW.FOREX-WAREZ.COM**  
**ANDREYBBRV@GMAIL.COM SKYPE: ANDREYBBRV**

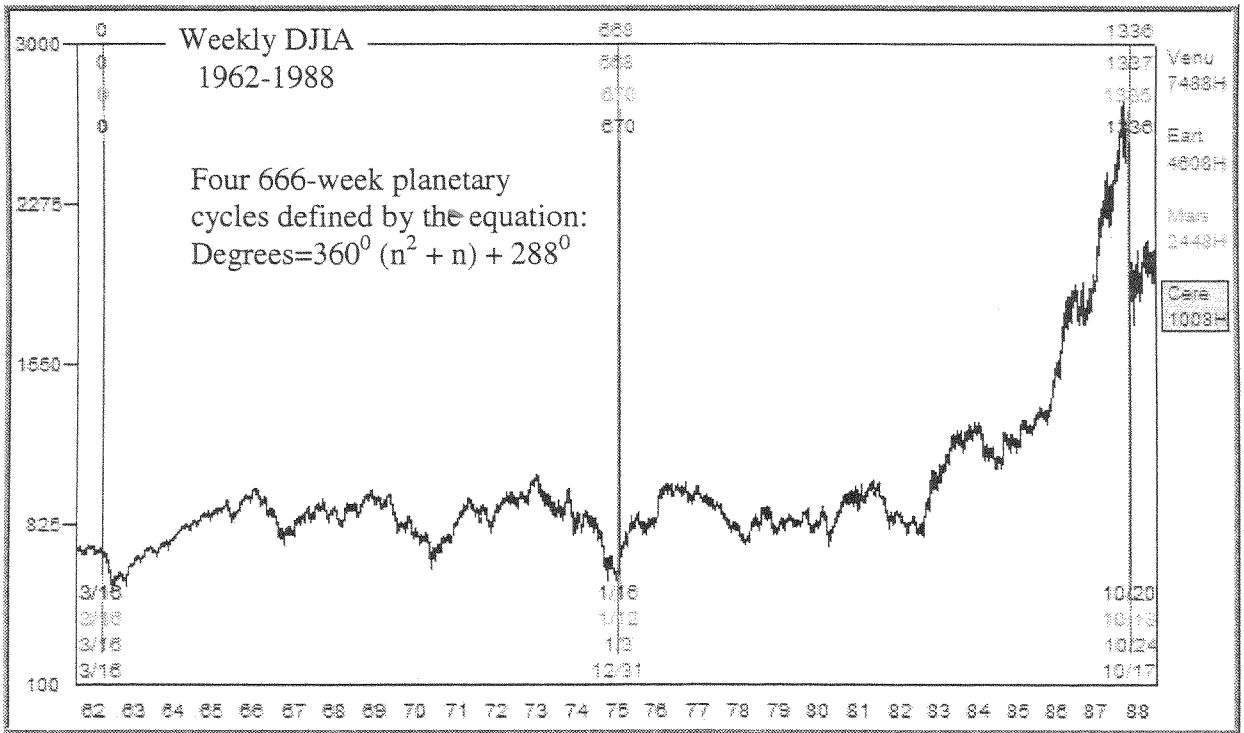


Chart 9.7

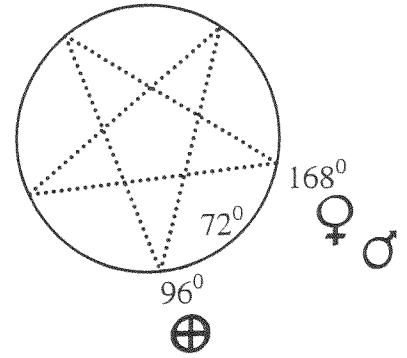
Four planets aligned with the 666-week Beast cycle using the displacement equation.

**THE PANIC OF 1984**

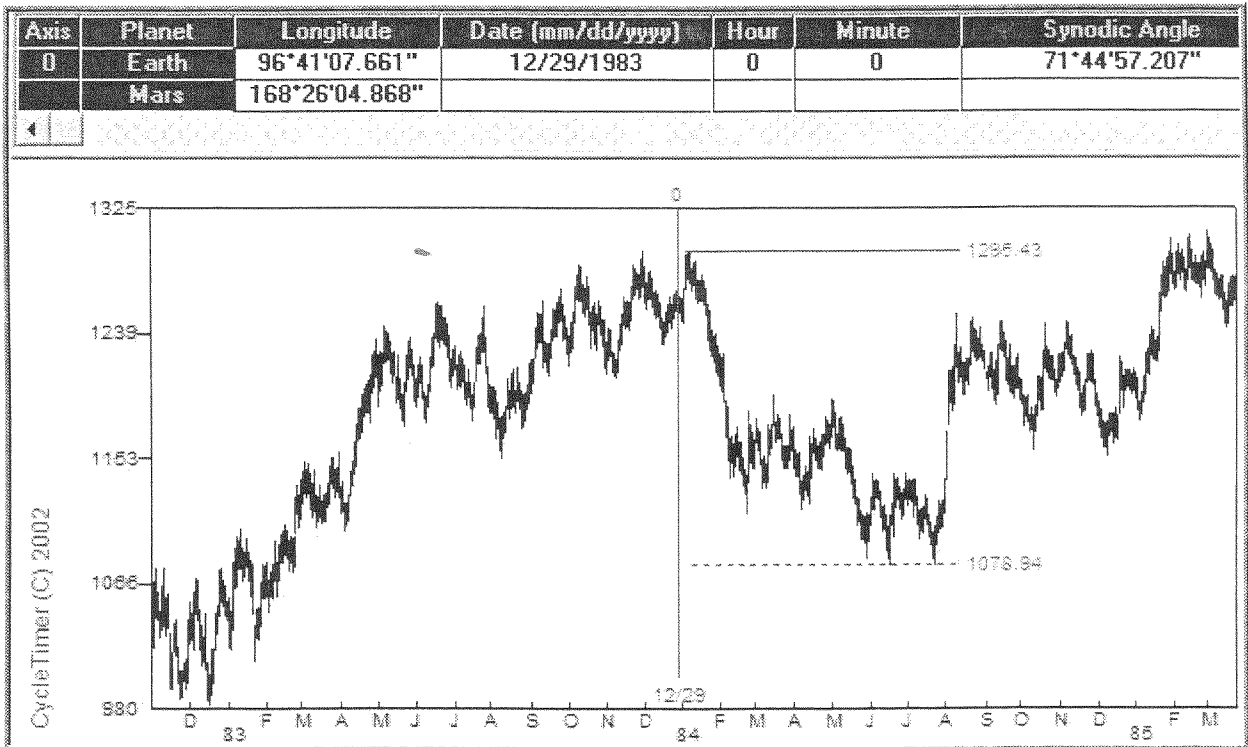
What is the result when the Earth-Venus-Mars combination simultaneously arrive at the Great Pentagram but are not arranged in a Golden Triangle? One such example is the panic of 1984, one of the few panics since 1949 that has not already been explained by the Great Pentagram.

At the end of 1983 Venus and Mars conjoined at the 168° pentagram point, 72° from Earth. Chart 9.8 shows the ensuing panic dropped prices 17% in seven months.

The bottom in late July 1984 was only two weeks from the Mars-Jupiter conjunction on August 12<sup>th</sup>, 1984.



**Figure 9.8**  
Panic of 1984 Great Pentagram.



**Chart 9.8**  
The Great Pentagram cycles at the panic of 1984.

**MORE CYCLES THAT WERE USED TO CALL THE MARCH 2009 BOTTOM**

An accurate market call usually incorporates several tools. One that was used real-time to time the bottom of 2009 has already been explained with the Saturn-Uranus cycle moving 180° from the 10/1987 crash low and 135° from the 4/1994 panic.

The market turned up with strength on March 9<sup>th</sup> during a double conjunction on the Great Pentagram. Earth-Saturn conjoined at 168°, and Jupiter-Mars conjoined at 308°.

Saturn and Uranus had also returned to Great Pentagram sensitive points with Saturn 540° (360° + 180°) from the 17-year cycle top on 2/9/1966. And as Chart 9.10 shows, Uranus was 144° from the corresponding mid-cycle panic low on 12/1974.

March is often a market turning date because it corresponds with Earth returning to the Great Pentagram. Table 9.1 shows the five dates each year when Earth crosses the Pentagram.

Table 9.4 shows that Mars and Jupiter will again conjoin on May 18, 2011 and August 16, 2013 (Beast). Each conjunction is rotated about 72° from the previous one and on the Great Pentagram.

Axis	Planet	Longitude	Date	Hour	Minute	Synodic Angle
0	Mars	308°48'01.643"	3/9/2009	0	0	0°38'26.686"
	Jupiter	308°09'34.957"				
0	Earth	168°33'04.799"	3/9/2009	0	0	0°10'10.093"
	Saturn	168°22'54.705"				

Double conjunction at 3/9/2009 bottom

**Table 9.3**

Double conjunction occurred on the Great Pentagram at the 3/9/2009 bottom.

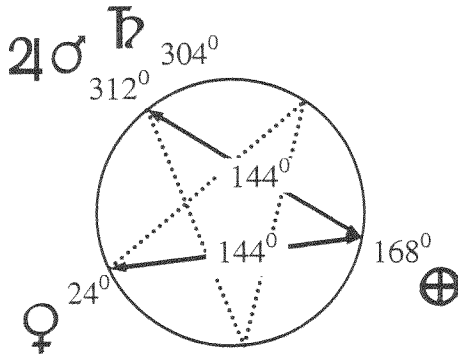
Axis	Planet	Longitude	Date	Synodic Angle	Change	Change (From Start)	Calendar Days
0	Mars	307°33'19.529"	3/7/2009	0°25'51.253"	N/A	N/A	0
	Jupiter	307°59'10.782"					
1	Mars	19°51'10.224"	5/18/2011	0°25'51.253"	360°00'00.000"	360°00'00.000"	802.25073
	Jupiter	20°17'01.477"					
2	Mars	93°02'26.553"	8/16/2013	0°25'51.253"	360°00'00.000"	720°00'00.000"	1623.46341
	Jupiter	93°28'17.806"					

**Table 9.4**

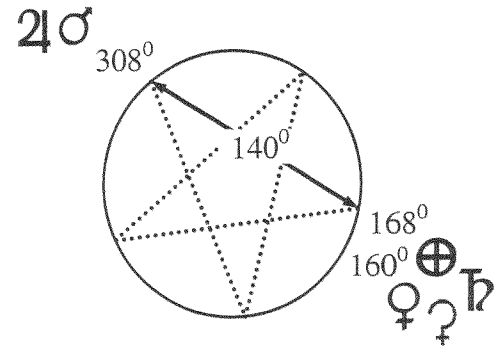
Jupiter-Mars conjunctions are rotated 72° and on the Great Pentagram.

Figure 9.9 shows that on 3/9/2009 Jupiter, Mars, and Earth returned to the same Great Pentagram points as 3/1962.

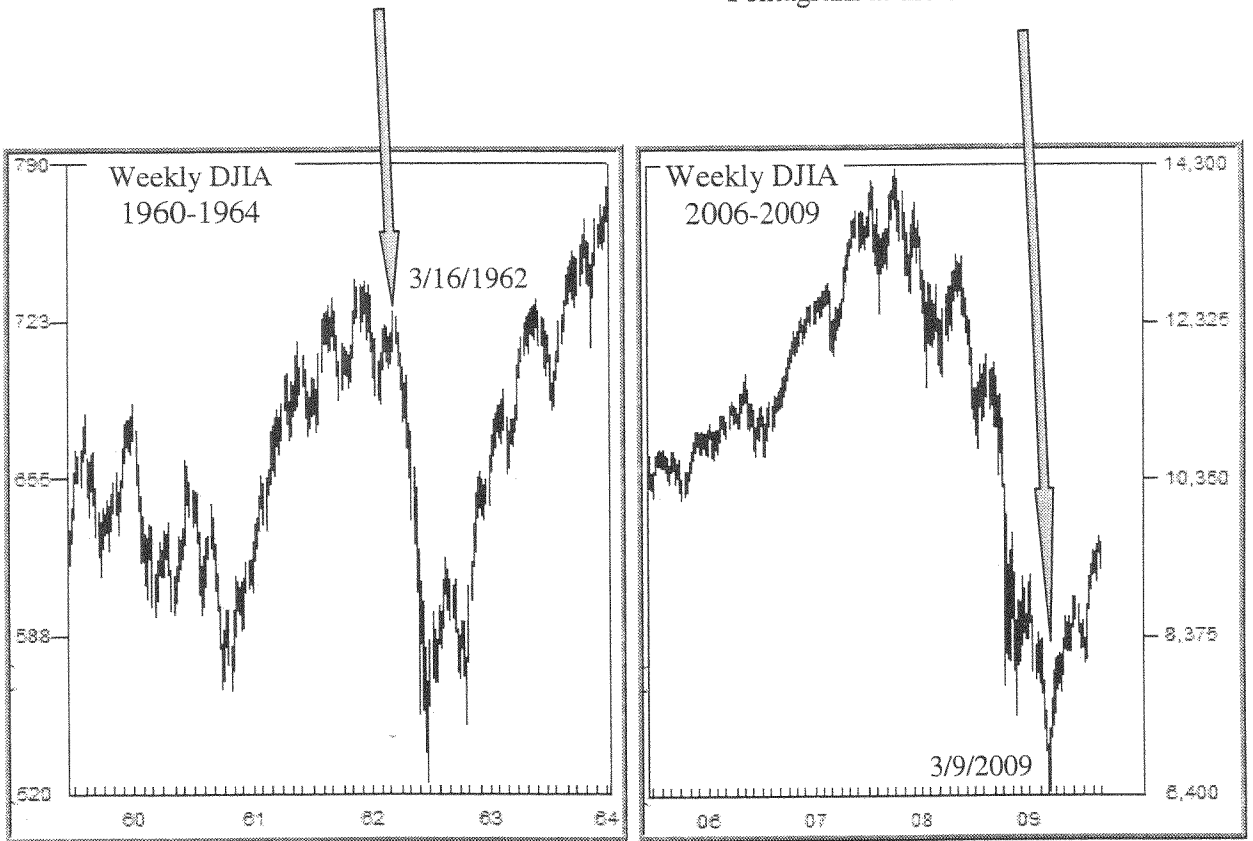
Venus and Ceres conjoined two days later at  $160^{\circ}$ , just short of the  $168^{\circ}$  conjunction of Earth-Saturn. Venus crossed  $168^{\circ}$  one week later.



**Figure 9.9.A**  
Golden Triangle at the crash of 3/1962



**Figure 9.9.B**  
Double conjunction on the Great Pentagram at the bottom of 3/9/2009



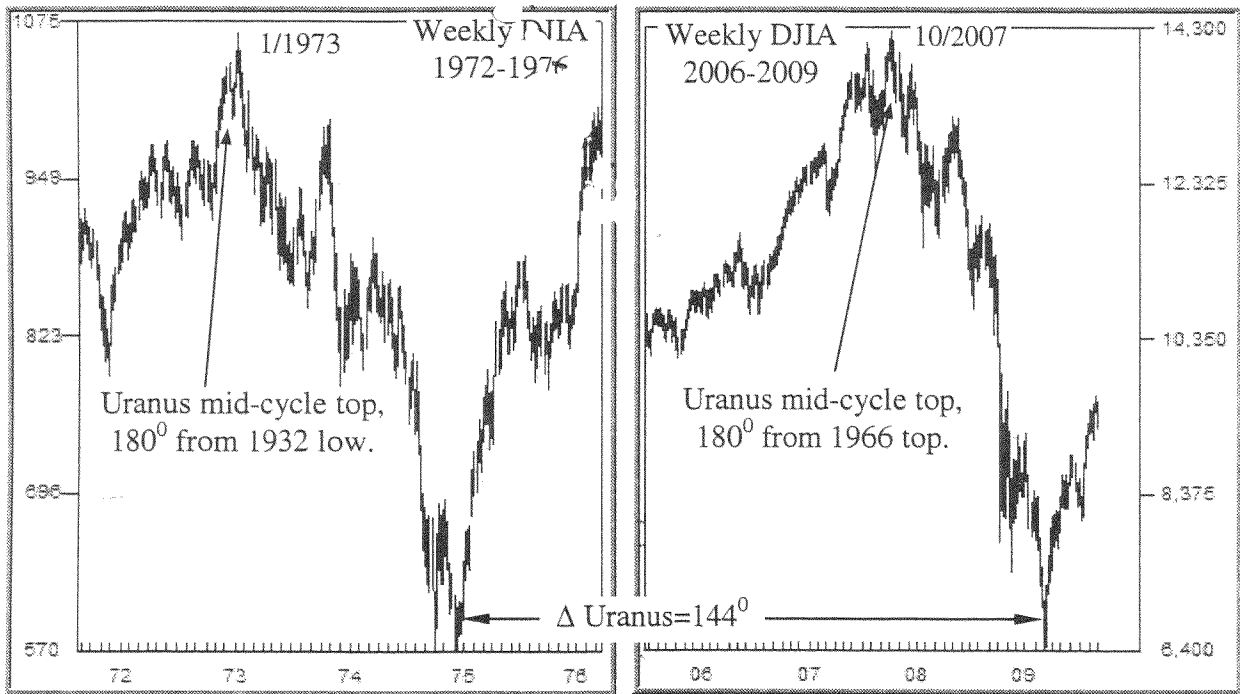
**Chart 9.9**  
Return of the 1962 Great Pentagram configuration in March 2009.



January 1973 was the 34-year mid-cycle top prior to 2007. Two 17-year cycles correspond with Uranus moving  $144^{\circ}$ . Measuring  $144^{\circ}$  Uranus from turns in the previous cycle does not always provide a reliable turning point. The exception is when this cycle arrives simultaneous to other planets on the Great Pentagram, as in March 2009.

The exact  $\Delta \text{Uranus}=144^{\circ}$  measured from the bottom on 12/9/1974 arrived on 3/26/2009. Uranus displacement between these two 17-year mid-cycle bottoms was  $143^{\circ}50'$ , very close for a slow moving planet such as Uranus.

This provides a good example of the merits of cycle triangulation. The analyst would not only look at the Uranus cycle from 12/1974, but also from many other points to arrive at a high probability date.



**Chart 9.10**

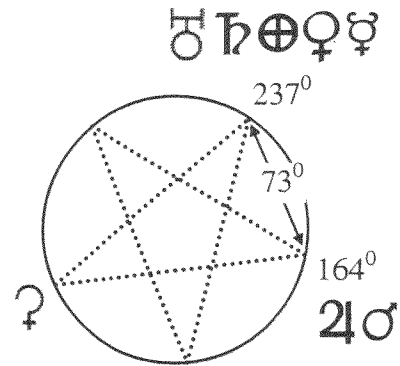
Corresponding mid-cycle panics 34 years apart. Bottoms are separated by  $\Delta \text{Uranus}=144^{\circ}$ .

### GRAND CONJUNCTION OF 1897

Figure 9.10 shows the planets orientation at the bottom in 1897. This date was a major astronomical event. In less than one month five planets converged on the Great Pentagram point  $237^{\circ}$ , the location of Earth at the birth of the NYSE on May 17, 1792.

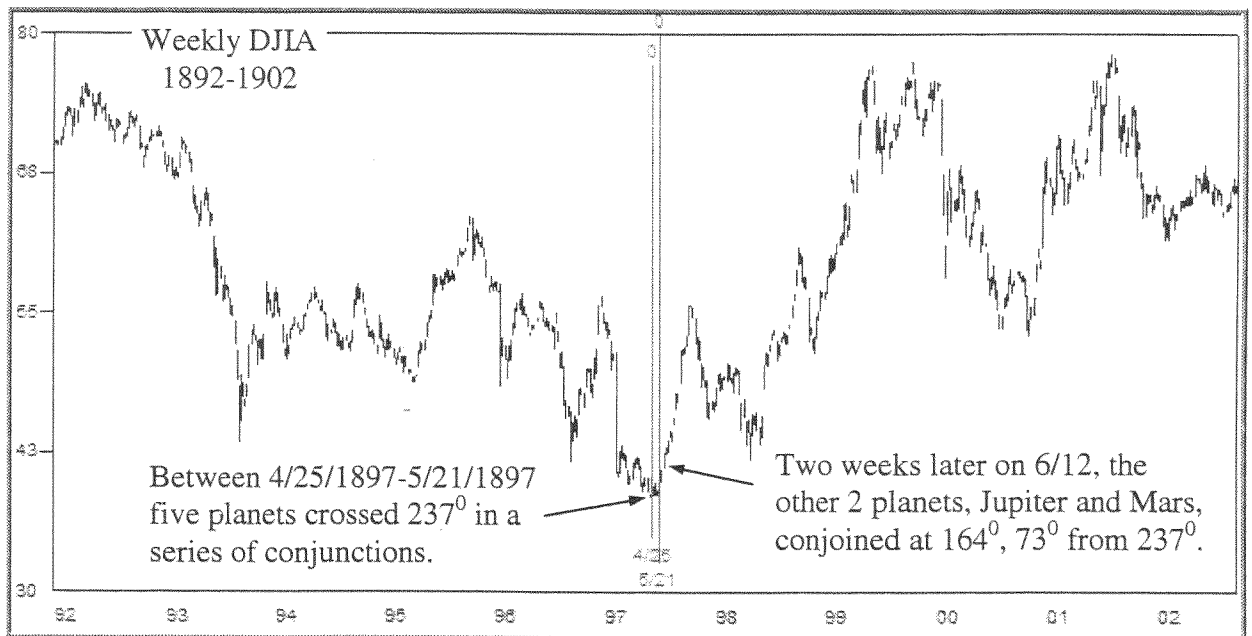
The remaining two planets, Mars and Jupiter, also conjoined a couple weeks later on the pentagram, completing the bottom and beginning the 50-year Jubilee cycle. 1897 was a major nodal point with both the 17 and 13-year cycles aligning. They next aligned in 1949 and 2000.

The reader is encouraged to study each of these dates on a daily chart to see how each of these cycles turned the market up in succession as they arrived at the nodal point.



**Figure 9.10**  
Grand conjunction of 1897

1897 was the half-way point between 1792 and 2000. Analysts running cycles from 1792 will notice they have to realign their cycles with the Grand Conjunction in 1897 for their location during the next 103-year interval.

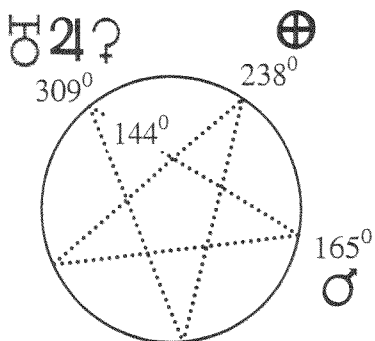


**Chart 9.11**  
Grand conjunction on the Great Pentagram in 1897.

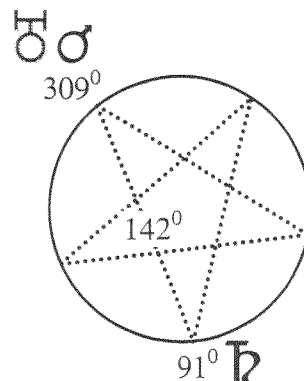
**1914 START OF WORLD WAR I**

After 1897, Uranus rotated  $72^\circ$  to the next Great Pentagram point on 5/21/1914. One month later Ferdinand was assassinated in Europe beginning World War I.

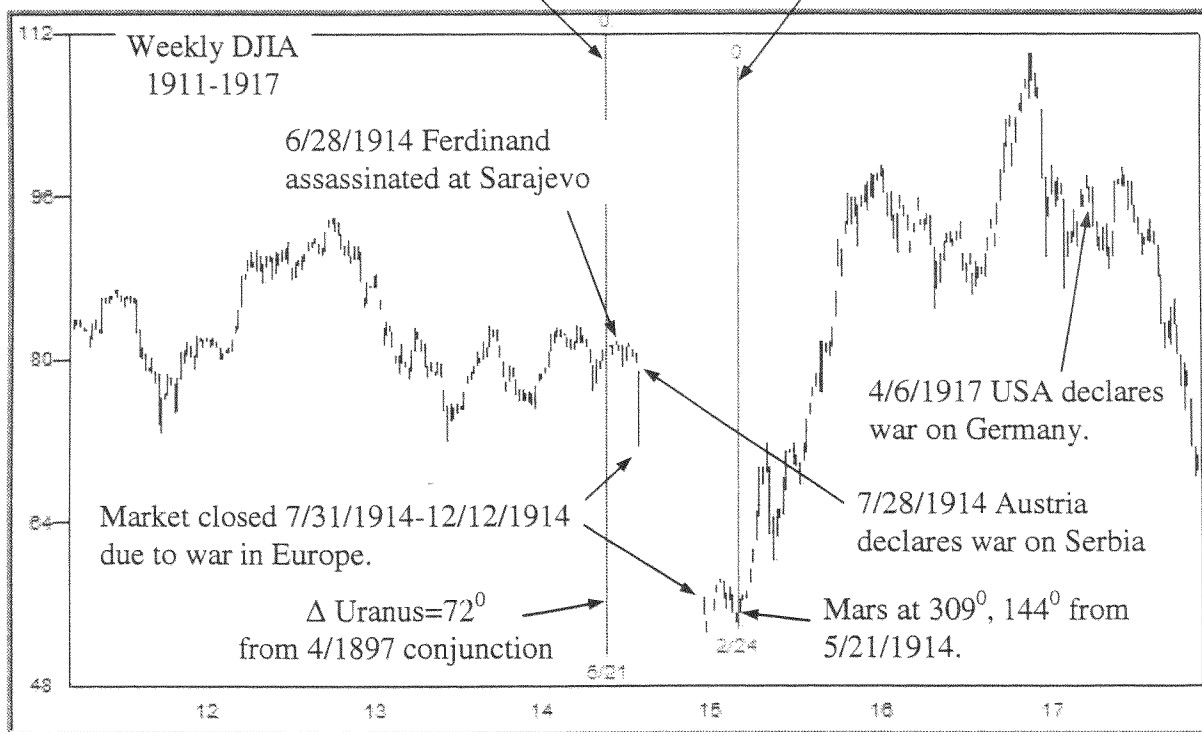
Figure 9.11.A shows the planets on the Great Pentagram on 5/21/1914. The market closed on 7/31/1914. After it reopened, it did not make a final bottom until 2/24/1915. This bottom coincided with Mars moving exactly  $144^\circ$  from 5/21/1914 to another point on the Great Pentagram.



**Figure 9.11.A**  
World War I cycles 5/21/1914



**Figure 9.11.B**  
World War I cycles 2/24/1915



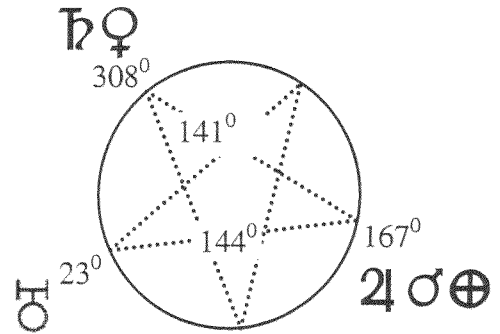
**Chart 9.12**

World War I started when Uranus moved  $72^\circ$  from the 1897 Grand Conjunction.

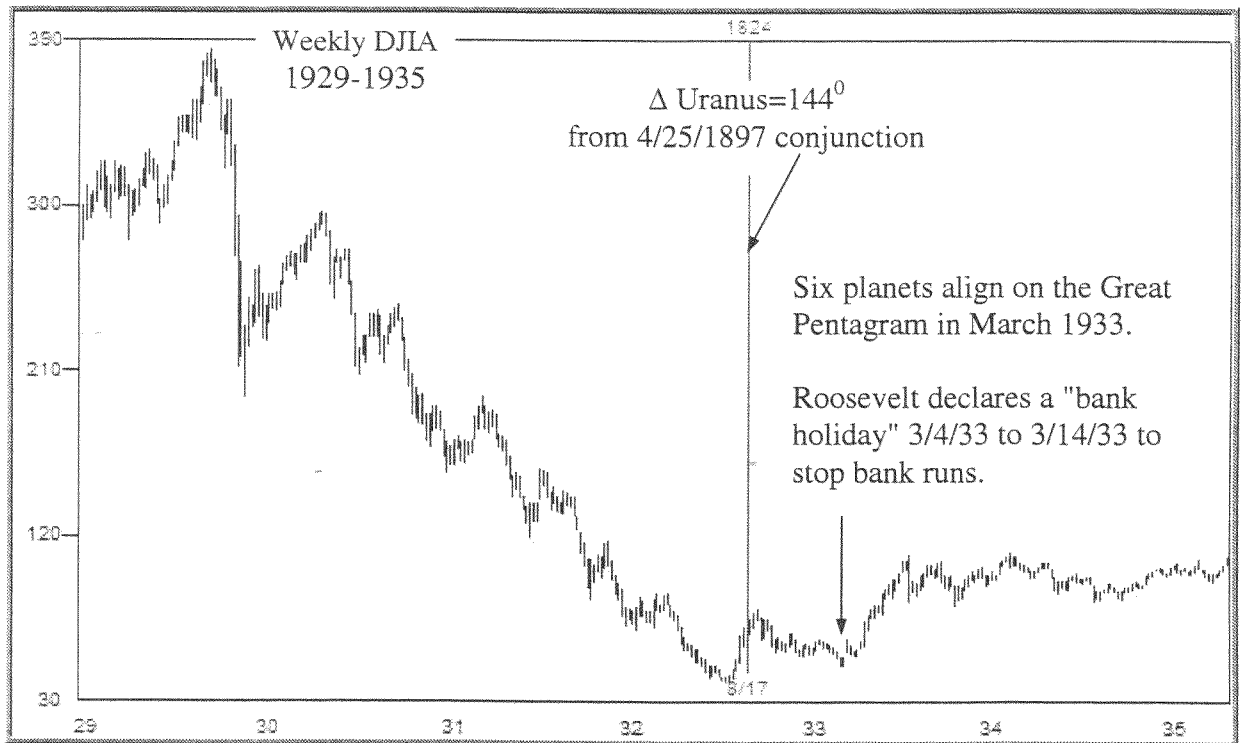
### GREAT DEPRESSION OF THE 1930s

One month after the July 1932 stock market bottom Uranus had moved exactly  $144^{\circ}$  from the great conjunction of 1897. Prices quickly rebounded but the rally was short-lived because the other planets had not yet arrived at the Great Pentagram.

Six months later in late February and early March 1933 the planets all aligned on the Great Pentagram. Uranus was at  $23^{\circ}$ , the location of Saturn at the 1792 birth of the NYSE. That alignment coincided with a period of great disruption with panics causing bank runs. Roosevelt closed the banks for two weeks to stop the bleeding. For the next five years the market had a massive rally back to 195, half of the 1929 high.



**Figure 9.12**  
Golden Triangle of 3/1933



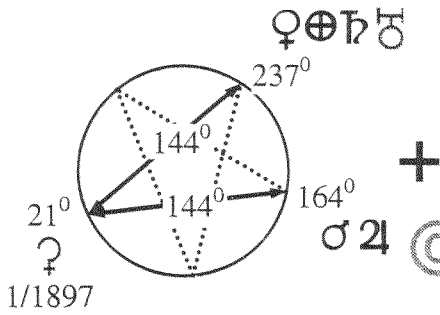
**Chart 9.13**

Six planets align in a Golden Triangle on the Great Pentagram at the 1930s depression low.

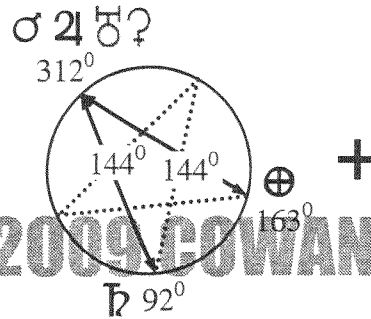
**TRIPLE TRIANGLE OF 1897, 1915, 1933**

When the three Golden Triangles at the major 17-year cycle bottoms are overlaid they form the Triple Triangle, or Great Pentagram, spanning 36 years from 1897 to 1933. This is the same pentagram that defined the 12.8-year cycles with the smaller fast moving planets, 1962, 1974, and 1987.

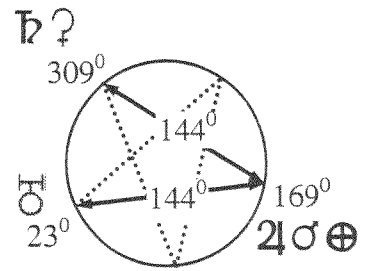
Notice in each triangle Jupiter was in conjunction with Mars, as it was at the 1792 signing of the Buttonwood Agreement. At the depression low in 1933 the conjunction occurred at the same zodiac location as in 1897. A review of Jupiter-Mars conjunctions shows they often correspond with turns when aligned with other cycles.



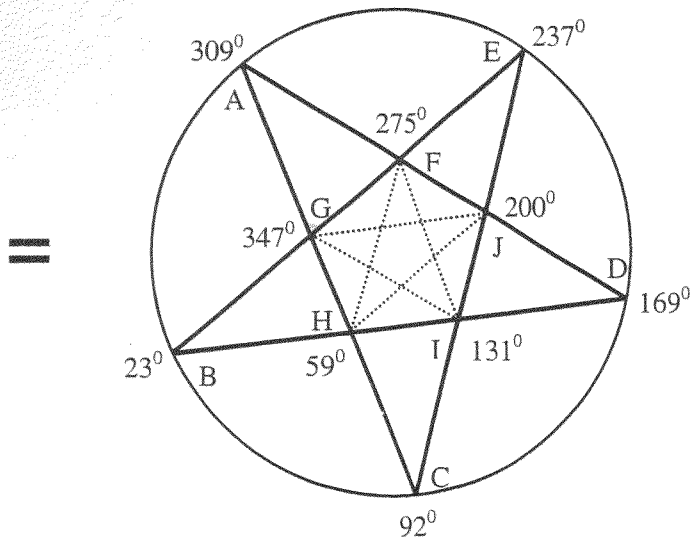
**Figure 9.13.A**  
1897 Golden Triangle



**Figure 9.13.B**  
1915 Golden Triangle



**Figure 9.13.C**  
1933 Golden Triangle



**Figure 9.13.D**  
Triple Triangle of 1897, 1914, and 1933

At the three major bottoms 1897-1914 - 1933 the major planets simultaneously arrive at points on the Great Pentagram in Golden Triangle formation.

Later dates see the relative speeds of Saturn and Uranus change somewhat causing them to arrive at the pentagram at slightly different times, resulting in the double top of 1966-1968.

### EARTH-VENUS AND SATURN-URANUS FORM PENTAGONAL FRACTAL PATTERNS

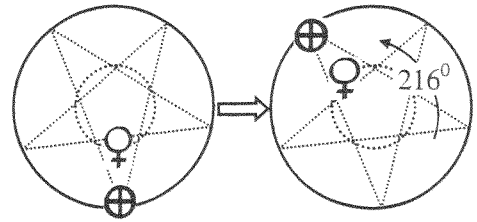
Figure 8.6 showed that the average movement of successive Earth-Venus conjunctions is  $216^{\circ}$ . It takes five conjunctions, defining five points on a pentagram, before one recurs at the same location. The total Earth-Venus displacement during five conjunctions is three complete  $360^{\circ}$  circles, or  $1,080^{\circ}$  ( $216^{\circ} \times 5 = 1,080^{\circ}$ ). Between each conjunction Earth goes all the way around the zodiac plus another  $216^{\circ}$  for a total of  $576^{\circ}$ . Venus goes all the way around twice plus another  $216^{\circ}$  for a total of  $936^{\circ}$ .<sup>28</sup>

Saturn-Uranus is the pentagonal counterpart of Earth-Venus on a larger scale.<sup>29</sup> Saturn moves  $216^{\circ}$  as Uranus moves  $72^{\circ}$  between the five points of the pentagram. It takes five such movements lasting 17 years each for Uranus to return to its point of origin and for Saturn= $216^{\circ}$  to hit all five points of the pentagram. During this time Saturn completes three  $360^{\circ}$  circles, or  $1,080^{\circ}$ . Just as Earth-Venus requires five  $216^{\circ}$  movements to complete the five points of the pentagram, so does Saturn require five cycles of  $216^{\circ}$  to complete the Uranus pentagram.

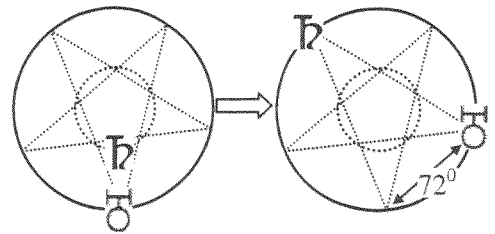
Figure 7.1 showed that every-other Saturn-Uranus conjunction moves about  $210^{\circ}$  from the previous one, similar to the  $216^{\circ}$  movement between successive Earth-Venus conjunctions.

<sup>28</sup> These numbers can be verified with the data in Tables 8.3-8.5. Divide the "Change from Start" degrees of each planet into that for Earth-Venus when the calendar days are equal, such as 2921.

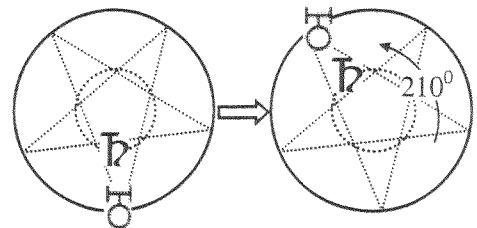
<sup>29</sup> *Four-Dimensional Stock Market Structures And Cycles* showed that Uranus is the planet that squares the Earth being  $19x$ 's further from the sun than is Earth.  $19 \times 19 = 361$ .



**Figure 9.14**  
Earth-Venus moves  $\sim 216^{\circ}$   
between conjunctions.



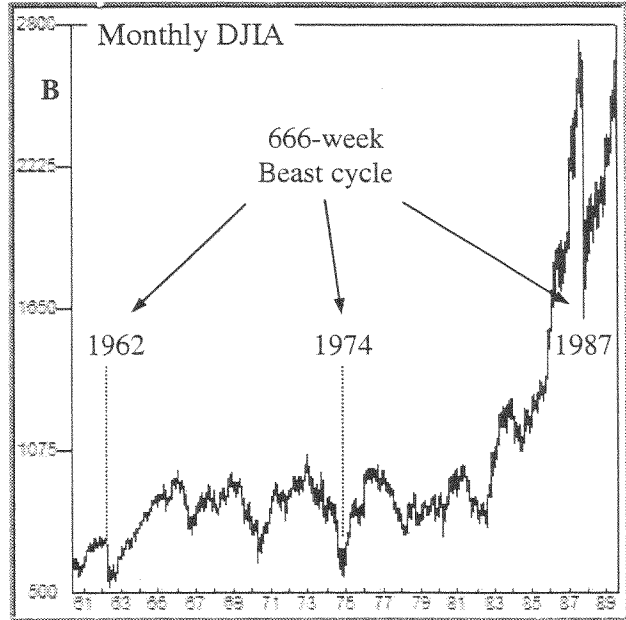
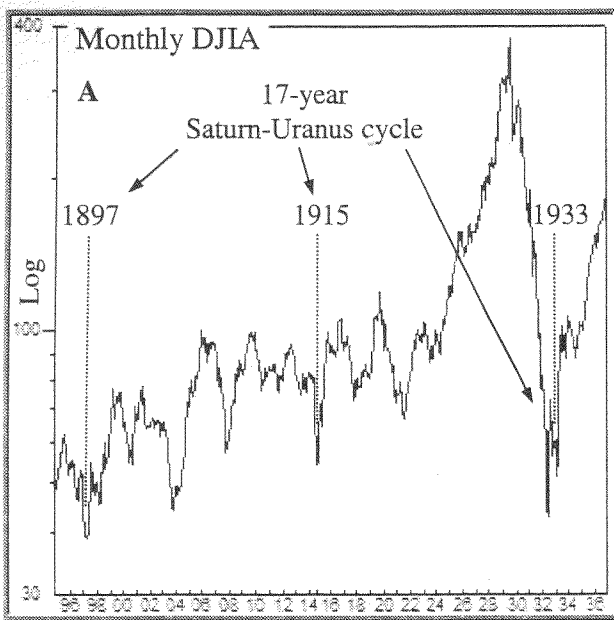
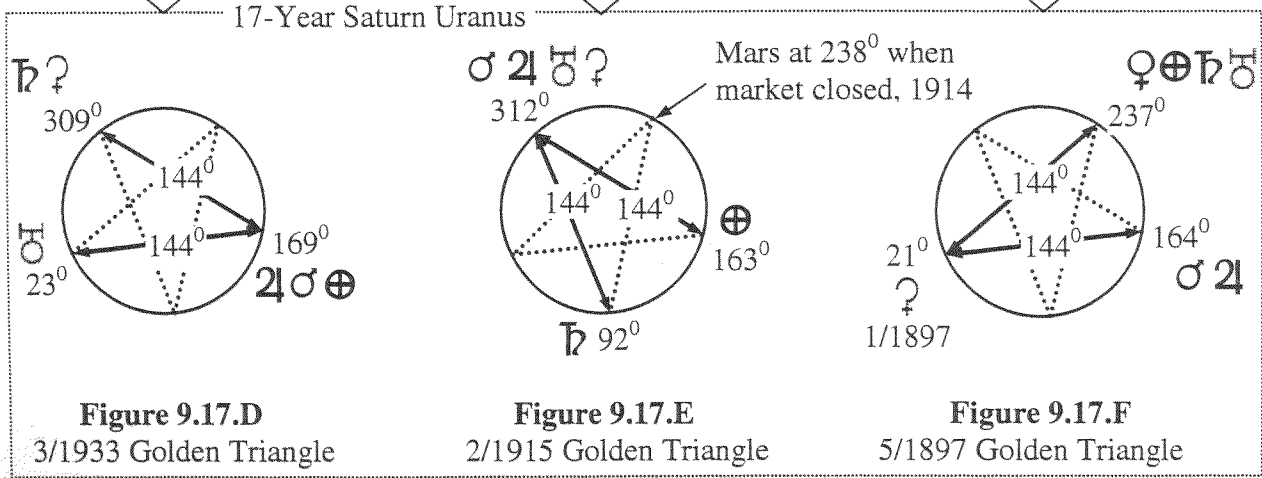
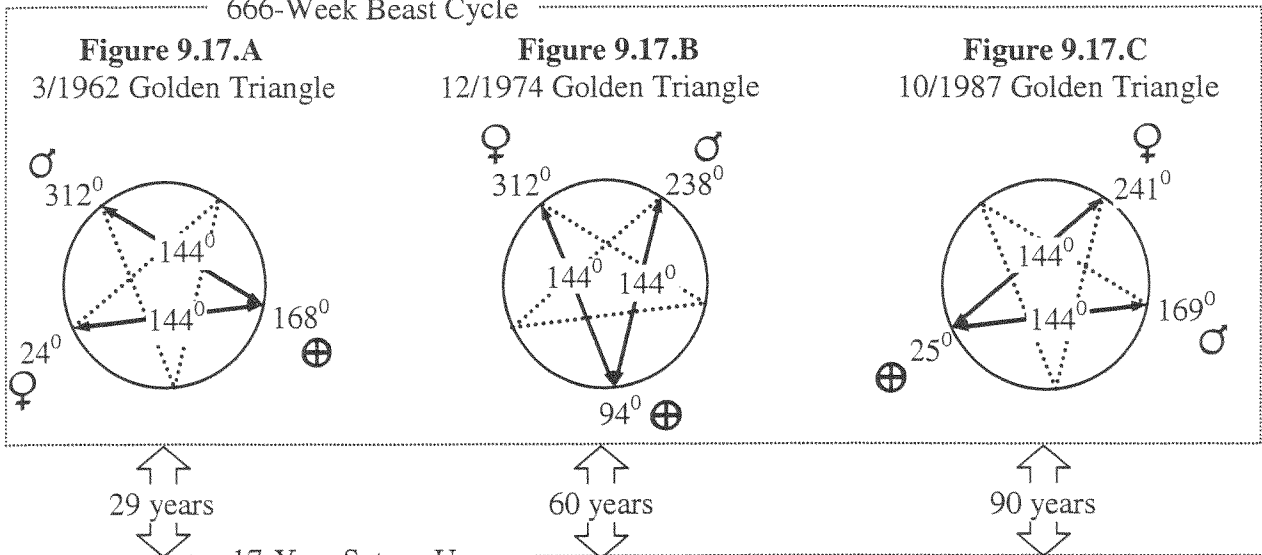
**Figure 9.15**  
Saturn moves  $\sim 216^{\circ}$  when  
Uranus moves  $72^{\circ}$ .



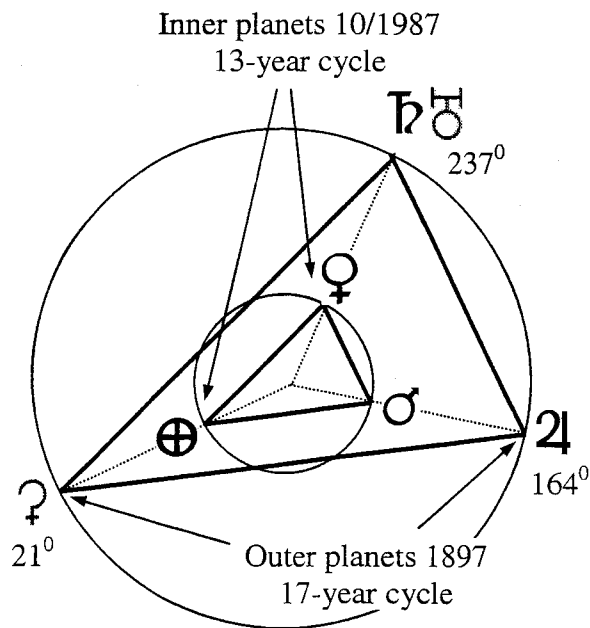
**Figure 9.16**  
Saturn-Uranus moves  $\sim 210^{\circ}$   
between alternating conjunctions.

Figure 9.17 and Chart 9.14.B show the fast moving inner planets that resonate with the 666-week Beast cycle. Directly below these three Golden Triangles are three matching recurrences of the slow moving Saturn-Uranus 17-year cycle. All these cycles resonate with the same five points on the Great Pentagram.

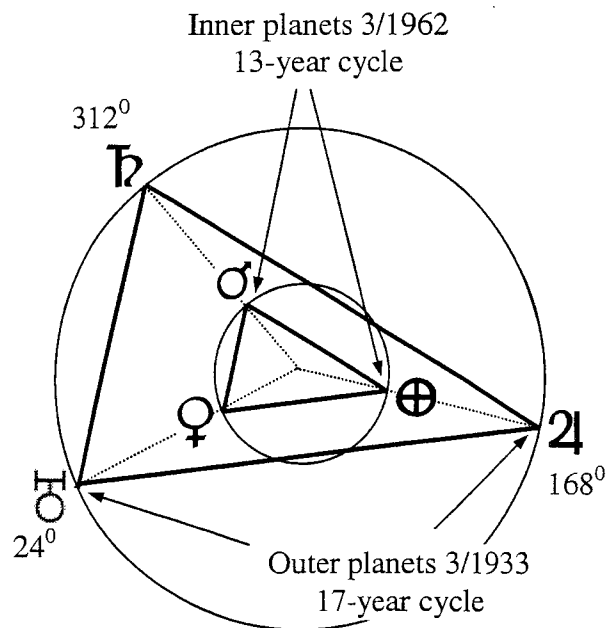
666-Week Beast Cycle



**Chart 9.14**  
Corresponding Golden Triangles of the outer and inner planets at 17-year and 13-year cycles.



**Figure 9.18**  
Golden Triangle fractal pattern  
of inner (1987) and outer planets (1897)



**Figure 9.19**  
Golden Triangle fractal pattern  
of inner (1962) and outer planets (1933)

The fast moving planets complete multiple orbits until they correctly align again on the Great Pentagram. Slow moving Uranus creeps along for 17-years from pentagram point to point.

Mandelbrot defined a fractal as, "a rough or fragmented geometric shape that can be split into parts, each of which is (at least approximately) a reduced-size copy of the whole."<sup>30</sup>

Between 1962 and 1987 the fast moving planets formed three Golden Triangles spaced 666 weeks apart. Each triangle was rotated 72° clockwise from its predecessor and formed at the same locations as the Golden Triangles formed years earlier during 1897-1933 by the outer planets.

Figures 9.16 and 9.17 show that the fast moving planets formed a Golden Triangle fractal pattern with the slower outer planets on the Great Pentagram.

The wheels within wheels pattern of Golden Triangles shows the inner planets rotating several times until realigning again into their Golden Triangle 666-weeks later. The outer planets move slowly forming the same Golden Triangle on the 17-year cycle.

The power of each cycle is greatly enhanced if many planets simultaneously arrive at the pentagram. Most of the 12.8-year cycles that caused great panics also had at least one of the major planets on the pentagram. Similarly, the 17-year cycle is triggered by the fast moving inner planets simultaneously crossing the pentagram.

<sup>30</sup> *The Fractal Geometry of Nature*, Mandelbrot



Market analysts have tried for years with marginal success to match market activity with previous charts. Typically, they move a chart back in time until they see an acceptable match. Sometimes they are lucky and match the correct historical section, sometimes unlucky and the comparison soon falls apart. Eventual failure is inevitable if there is no disciplined technique of identifying the beginning and ending dates when the action should repeat.

WD Gann's 1931 course *Forecasting* used the decennial pattern and matched markets back 10, 20, 30, etc years. Some think this was the basis of his *Master Time Factor*. Edgar Lawrence Smith also used this same decennial pattern in his 1939 book *Tides in the Affairs of Men*.

Pentagonal time cycle theory allows the analyst to calculate with great accuracy when past market activity will recur. When this technique is mastered forecasts can be made for repeating market patterns extending for decades. This analysis will use monthly charts from 1857 to 2009. However, the same methodology can be used on the daily or hourly charts.

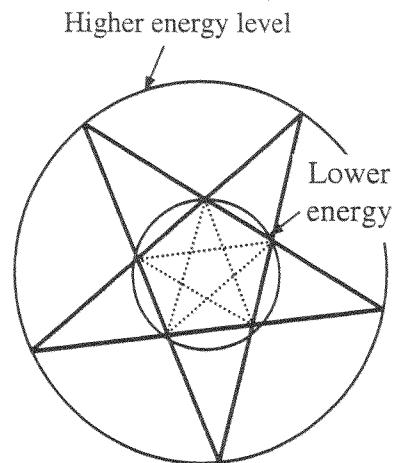
Pentagonal gnomonic expansion will be studied to show how events etched on the circle of time continue to repeat again-and-again. This same pentagonal gnomonic expansion can be seen in ancient temples and in the periods of the planets. Many previously presented concepts and cycles will be brought together to lay the groundwork for predicting repeating market patterns.

Using pentagonal decomposition, the 13-year, 17-year, Venus, Uranus, Mars, and Saturn-Uranus cycles will all be derived from one larger cosmological cycle, the 25,756-year precession of the equinox.

### **EXPANDING PENTAGONAL ENERGY LEVELS**

Time cycles rotate around a circle, reversing trend at key sensitive points. The number and spacing of these points outline geometric structures in space until the cycle completes. Then the action moves up to a higher energy level, or a larger circle, and the same time cycle pattern of highs and lows repeat on the larger cycle as they did on the smaller one. It is the magnitude of the price changes that has increased at the higher energy level not their time spacing.

Pentagonal geometry measures the spacing between the inner and outer circles giving the size of the larger pentagram and circle.



**Figure 10.1**  
Pentagonal cycle expansion

Huntley's book *The Divine Proportion*<sup>31</sup> showed that the Golden Ratio is found throughout the pentagram. One example is the expansion of the arms as they extend from a central pentagon. If the side of the inner pentagon is one, then the arms extending from that pentagon are 1.618,  $\Phi$ , and the entire span of the pentagram from tip-to-tip is 4.2358,  $\Phi^3$ . It is this ratio that defines the expansion in time from the inner circle to the outer.

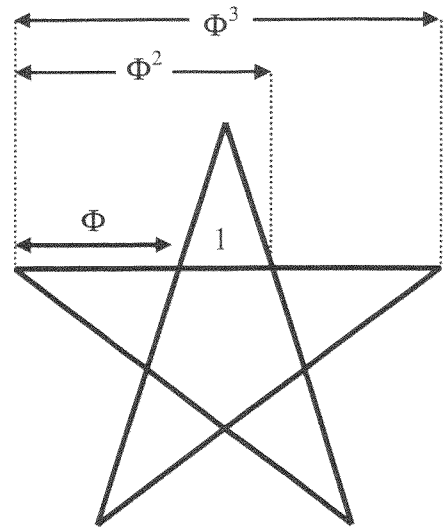
**PENTAGONAL EXPANSION OF URANUS TO THE EQUINOX PRECESSION CYCLE**

If the side length EF of the inner pentagon in Figure 10.3 is set to the Uranus cycle of 17 years (84/5) the golden ratios of the pentagram become:

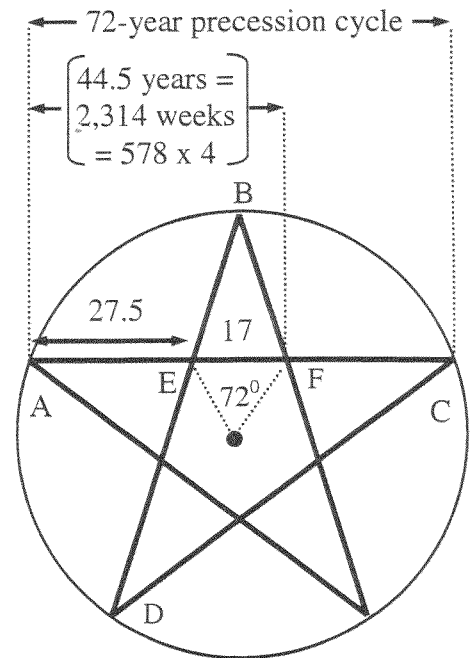
- 17 years = Side of the Uranus pentagon
- 17 x  $\Phi$  = 27.5  $\approx$  Saturn (29.3)
- 17 x  $\Phi^2$  = 44.5  $\approx$  Saturn-Uranus (45.3)
- 17 x  $\Phi^3$  = 72 = Equinox precession cycle

Only a pentagon with side length of 17 extends to a pentagram with a span equal to its inner angle of  $72^\circ$ . In other words, only when the side of the pentagon is 17 does a one-to-one relationship exist between the angle ( $72^\circ$ ) swept out between two pentagon points EF and the span of the extended pentagram (72 years). The span of the pentagram AC is the side of the Golden Triangle ACD.

The 72 years of the expanded Uranus pentagram equals the equinox precession cycle. Due to the wobble of the Earth's axis the location of the equinox slowly moves around the zodiac.



**Figure 10.2**  
Golden ratios in the pentagram



**Figure 10.3**  
Uranus 17-year pentagon expands to the 45-year Saturn-Uranus cycle, and the 72-year precession of the equinox.

<sup>31</sup> Referenced sections of *The Divine Proportion* are included in Appendix C.

A complete  $360^{\circ}$  cycle takes about 25,756 years, or 71.54 years per degree.

$$\frac{25,756 \text{ years}}{360^{\circ}} = 71.54 \text{ years per degree}$$

The inner Uranus pentagon can be derived from the precession cycle of 71.54 years by dividing by  $\Phi^3$ ,

$$\frac{71.54 \text{ years}}{\Phi^3} = \frac{71.54 \text{ years}}{4.236} = 16.89 \text{ years}$$

Giving a pentagon perimeter of  $16.89 \times 5 = 84.45$  years, very close to the actual 84-year Uranus cycle.

Using the 71.54-year precession cycle, the value of AF from Figure 10.3 is found to be the 4<sup>th</sup> Square of Twelve.

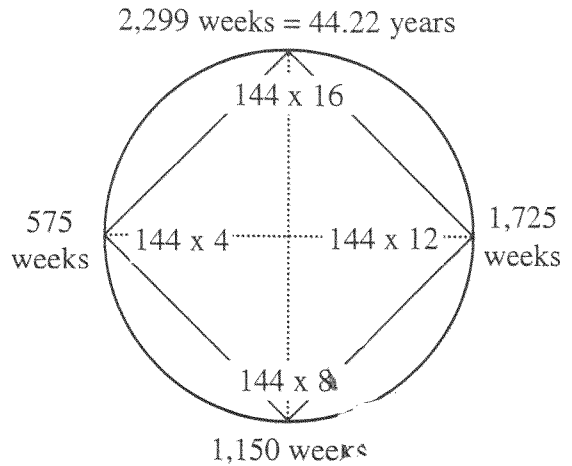
$$\begin{aligned} \text{AF} &= \frac{71.54 \text{ years}}{\Phi} = \frac{71.54}{1.618} = 44.22 \text{ years} \\ &= 2,299 \text{ weeks} = 575 \text{ weeks} \times 4 \end{aligned}$$

Figure 10.4 shows how four recurrences of this 575-week cycle create a square approximating the Saturn-Uranus cycle of 45.3-years (2,357 weeks).

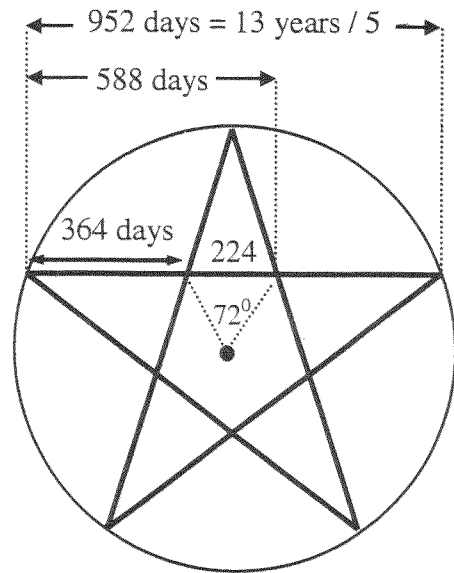
**EARTH-VENUS IS A PENTAGONAL TIME FRACTAL OF SATURN-URANUS**

The previous chapter showed that the Earth-Venus-Mars combination formed Golden Triangle fractal patterns with Saturn-Uranus-Jupiter. The time expansion between the orbits of these inner planets also form fractals with the outer planets.

Figure 10.5 uses the 224.69-day period of Venus as the side length of the inner pentagon, just as Figure 10.3 used the Uranus 17-year cycle as the side length of that pentagon. The 365-day period of Earth



**Figure 10.4**  
Pentagonal decomposition of the precession cycle to the S-U cycle.



**Figure 10.5**  
Venus pentagram expands to 1/5 the 13-year cycle.

is the pentagram arm, or  $\Phi$  times Venus. The 584-day synodic period of Earth-Venus is  $\Phi^2$  times the unit value of 224.69 days.

$$224.69 \text{ days} = \text{Period of Venus}$$

$$224.69 \times \Phi = 363.55 \text{ (Earth} = 365.24 \text{ days)}$$

$$224.69 \times \Phi^2 = 588.24 \text{ (Earth-Venus} = 584)$$

Table 7.1 showed the period of Saturn-Uranus is 45.33 years, or 2,357 weeks.

$$2,357 \text{ weeks} = 589 \text{ weeks} \times 4$$

$\Phi^2$  measures the time expansion from the 224-day sidereal Venus cycle to the 584-day synodic Earth-Venus cycle.  $\Phi^2$  also measures the time expansion from the 17-year sidereal Uranus cycle to the 45-year (588 weeks  $\times$  4) synodic Saturn-Uranus cycle.

The two planetary combinations, Earth-Venus and Saturn-Uranus, are pentagonal time fractals with Earth-Venus using daily time units and Saturn-Uranus using weeks.

### **PENTAGONAL EXPANSION OF VENUS TO THE 666-WEEK BEAST CYCLE**

Expanding the Venus pentagram to its full width produces a span of 952 days or  $1/5^{\text{th}}$  the 13-year cycle. This 952-day interval is one side of the pentagon in the center of the large pentagram in Figure 10.8 with a 13-year perimeter.

$$224.69 \times \Phi^3 = 952 \text{ days} = 13 \text{ years} / 5$$

The 952-day interval of the fully expanded Venus pentagram is close to the  $\Delta$  Earth-Venus=576<sup>0</sup> cycle of 935 days, five recurrences of which is 12.8-years, or the 666-week Beast cycle.

$$\frac{935 \times 5}{365.24} = \frac{4,675 \text{ days}}{365.24} = 12.8 \text{ yrs} = 666 \text{ weeks}$$

The mechanics of pentagonal decomposition explains why the 13-year cycle subdivides into Fibonacci ratios ( $\Phi$ ) of 8 and 5 years.

Five recurrences of  $\Delta$  Earth-Venus=576<sup>0</sup> subdivides into Fibonacci multiples of 2 and 3 to produce the five and eight-year cycles. Compare Chart 8.11, that showed subdivisions of the 13-year cycle into five parts, with Figures 10.7 and 10.8 for a better understanding of the 666-week Beast cycle with its 5 and 8-year harmonics.

### **PENTAGONAL DECOMPOSITION IN THE ANCIENT TEMPLE OSIRION**

In Robert Lawlor's book *Sacred Geometry* he applies the same pentagonal decomposition to the construct of the ancient Egyptian temple of Osirion. Built around 1300 BC this temple is arranged as a series of pentagons of decreasing size characterizing rebirth and renewal.<sup>32</sup>

Figure 10.7 uses Lawlor's pentagonal decomposition diagram of the Osirion temple to demonstrate pentagonal cosmology. On the left side of this diagram is the pentagonal decomposition of the precession of the equinox cycle starting with the 44.22-year value from Figure 10.4.

$$71.54 / \Phi = 44.22 \text{ years}$$

The decomposition from largest pentagram to smallest is the same as shown for the pentagonal star on page 29 of Huntley's book *The Divine Proportion*.<sup>33</sup> Dividing each daily time period by  $\Phi$  gives the one below it.

$$1 \quad \dots \quad \frac{1}{\Phi} \quad \dots \quad \frac{1}{\Phi^2} \quad \dots \quad \frac{1}{\Phi^3}$$

On the right side of Figure 10.7 are the planetary cycles corresponding with the

<sup>32</sup> Reference pages 60-63 of Lawlor's book for a much more detailed analysis of the pentagonal nature of the Osirion Temple.

<sup>33</sup> Reference Appendix C.

pentagonal value on the left. This diagram shows the pentagonal nature of the orbits within the Solar System. When planetary cycles unfold in pentagonal constructs those cycles manifest here on Earth with similar pentagonal patterns, "as above, so below". The ancients were undoubtedly familiar with this cosmology and left their temples as historical testaments to their knowledge.

Figure 10.8 illustrates this pentagonal decomposition as a series of expanding circles and pentagrams. The only difference is that the temple's pentagons are laid outside of each other, whereas the pentagons in Figure 10.8 are flipped over so they are each contained within the next larger one.

**SAROS CYCLE**

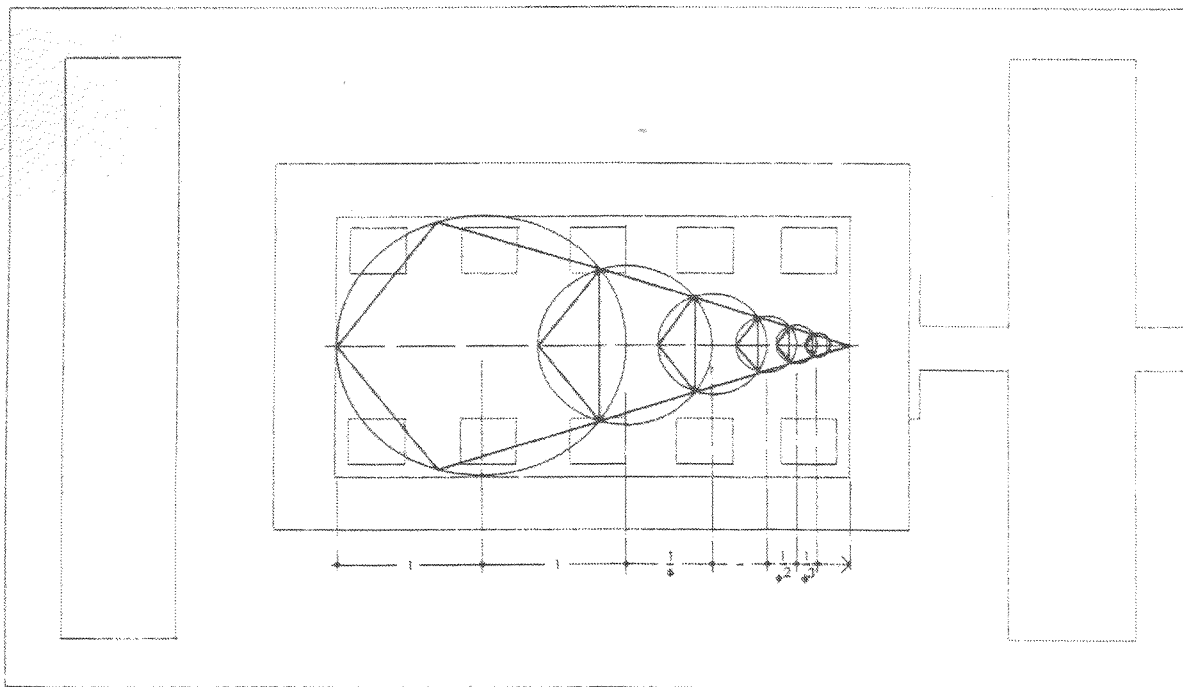
Every 18 years 11 days, or 6,585 days, the Earth, Sun, and Moon return to the same

orientation in the Zodiac creating an eclipse at the same location. This is called the Saros Cycle.

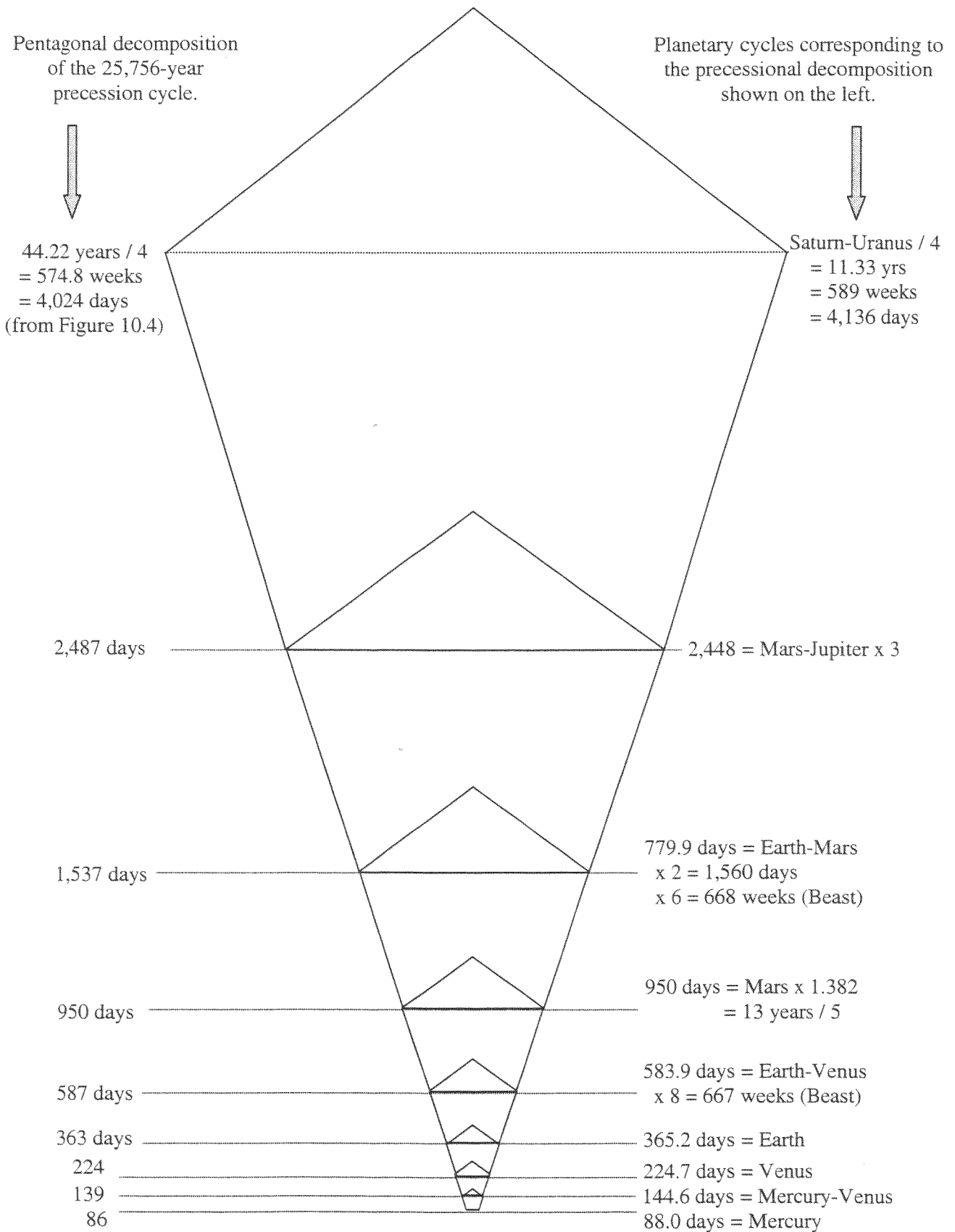
Pentagonal decomposition of the Saros cycle produces similar results as on the left side of Figure 10.7, the precession of the equinox. Beginning with 6,585 and dividing by  $\Phi$  produces the series,

6585, 4070, 2515, 1555, 961, 594, 367, 227, 140, 87 days

The reader can compare this Saros series with the planetary cycles on the right of Figure 10.7. This provides a link for research connecting the 666-week Beast cycle with eclipses. Any time the fast-moving moon is brought into the analysis the timing window is greatly narrowed.



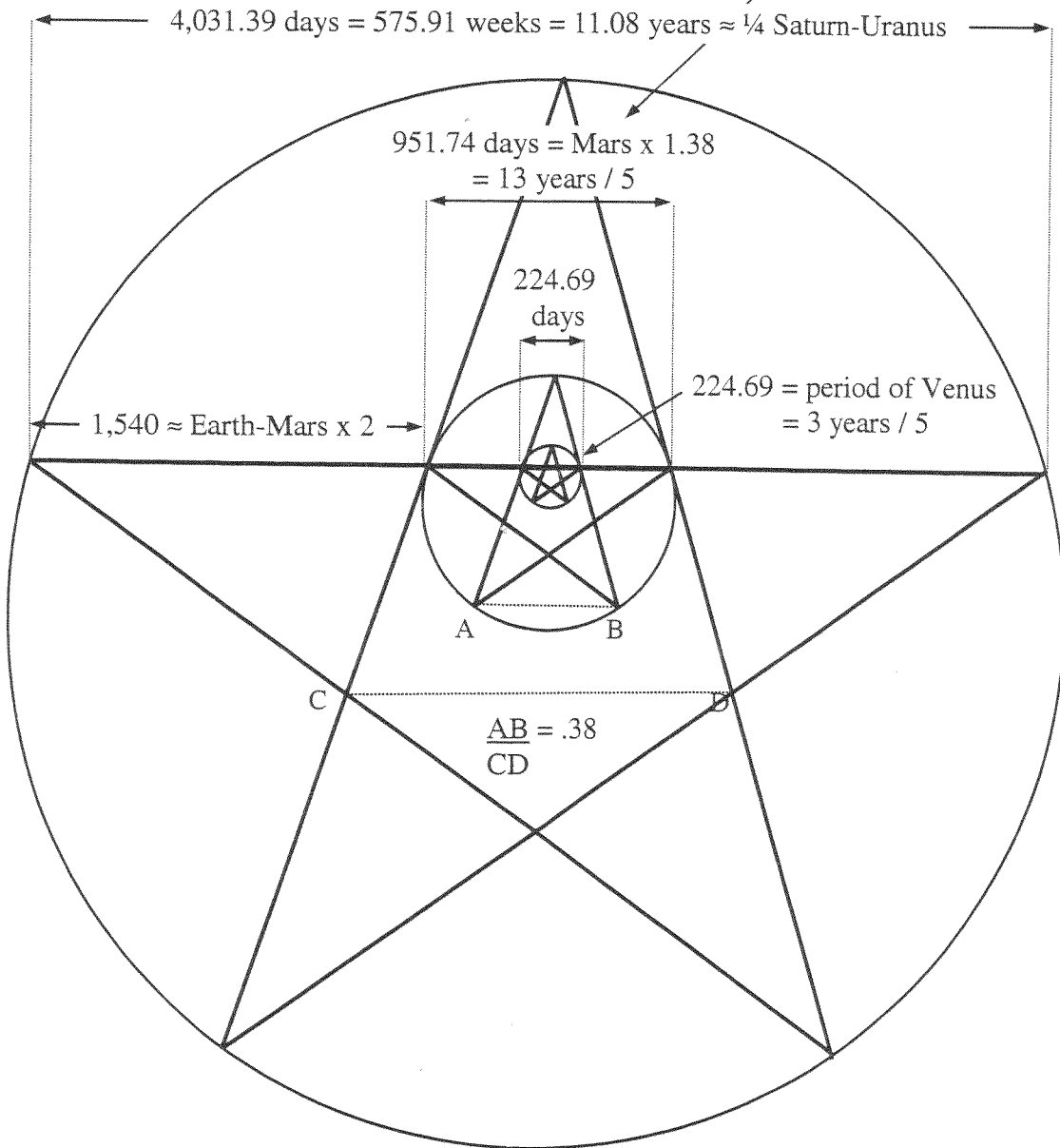
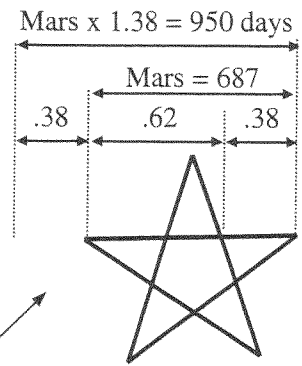
**Figure 10.6**  
Osirion Temple in Egypt showing the same pentagonal decomposition as Figure 10.7. Reproduced from *Sacred Geometry* by Robert Lawlor.



**Figure 10.7**  
Pentagonal decomposition of the 71.54-year precession cycle into planetary cycles.

$$\frac{25,756 \text{ years}}{(360^0 \times \Phi \times 4)} \times \frac{52 \text{ weeks}}{\text{year}} = 574.8 \text{ weeks}$$

The 4<sup>th</sup> Square of Twelve, 576, links the inner planets with the 25,756-year precession cycle.

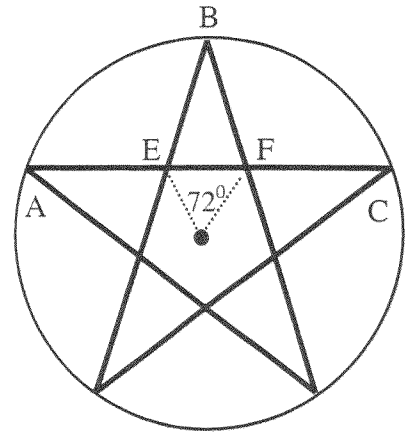


**Figure 10.8**

Pentagonal expansion of the Venus cycle to the 25,756-year precession cycle.

### THREE-DIMENSIONAL PERSPECTIVE OF PENTAGONAL CYCLES

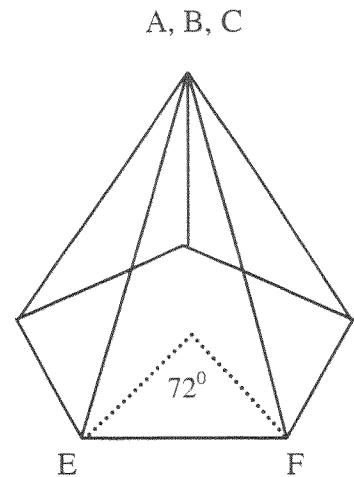
The Square of Twelve,  $144^0$ , is swept out when a point is rotated around an arc touching three points of a pentagram, such as ABC. When the inner angle sweeps out  $72^0$  it has only defined two points on the inner pentagon, EF, not the points on the extended arms, AC. The two-dimensional diagram of the pentagram shows that  $144^0$  of motion around the circle is required to sweep out the arc ABC.



**Figure 10.9**  
Pentagram in two dimensions

To get a better idea of what is really happening with the pentagonal cycle, you need to look beyond the flat 2-dimensional diagram of Figure 10.9 and fold the arms of the pentagram up to meet at a common point, forming a pentagonal pyramid.<sup>34</sup> In this 3-dimensional pyramid lines AE and BE become the same line, forming a common edge in the structure. Similarly, BF and CF form a common edge. This pyramid shows that one side of the 3-dimensional pyramid BEF is completed in  $72^0$ . Also, one side of the two triangles touching BEF are completed, AE and CF.

On the 2-dimensional plane only BEF has completed in  $72^0$ . However, the 3-dimensional pyramid shows the common edges AE and CF also completed. When unfolded onto a 2-dimensional plane these completed sides comprise AE, BE, BF, and CF in Figure 10.9, spanning  $144^0$ .



**Figure 10.10**  
Pentagonal Pyramid

This is how the apparent motion of  $72^0$  on a 2-dimensional plane expands into the next larger cycle of  $144^0$ . When moving around the base of the pyramid in  $72^0$  increments the sides of the 3-dimensional pyramid are also being formed, to be unfolded into the next larger circle, or cycle.

<sup>34</sup> Reference Appendix C, *The Devine Proportion*, Huntley



### **EXAMPLE OF EXPANDING PENTAGRAMS AT HIGHER ENERGY LEVELS**

Chart 4.4 showed that  $180^{\circ}$  Uranus from the 1966 top located the mid-cycle top in October 2007, leading to the panic of 2007-2009. For the sake of simplicity, that figure was drawn with the 1966 point on the outer circle and 2007 on the inner circle. Because 2007 occurred after 1966 it was actually on a larger outer circle and the circle that contained the 1966 point was on the smaller inner circle, as shown in Figure 10.12.

The point on the pentagram that occurred  $180^{\circ}$  earlier than 1966 was the beginning of the 5-year cycle in 5/20/1924. That was an acceleration bottom with prices advancing rapidly into the speculative frenzy of 1929.

When all three of these pentagrams are drawn together the 1924 and 2007 points are seen to be at the same Uranus zodiac location,  $347^{\circ}$ , which is  $36^{\circ}$  from the Great Pentagon point of  $311^{\circ}$  in 1914 and 1998.

Notice the highly volatile region corresponding to 1941, 1858, 1774, etc. This area has historically coincided with the most deadly American wars, World War II, Civil War, and Revolutionary War, as explained in *Four-Dimensional Stock Market Structures And Cycles*.

The 3-dimensional perspective of these pentagrams is shown in Figure 10.11 where the arms of the middle pentagram are folded up into a pentagonal pyramid. The 17-year cycles from 1897 to 1982 are the top points of the pyramid. They were defined by one complete Uranus cycle originating with the 1897 Saturn-Uranus conjunction. The sides of the pyramid fold down when the cycle completes and the points that were at the top of the 1897-1982 pyramid form the base of

the next larger pentagram. The key points in the new pentagram are the 17-year cycles in 2000, 2017, etc.

The base of the pyramid in Figure 10.11 shows the mid-cycle turning points defined by  $180^{\circ}$  Uranus from the five key points at the top of the pyramid, or the larger outer pentagram. For example, 1966 was shown to be  $180^{\circ}$  Uranus from 1924, 1973 was  $180^{\circ}$  from 1932, etc.

### **FORECASTING TIME INTERVALS BETWEEN REPEATING PATTERNS**

Two and three-dimensional geometry of increasing energy levels illustrates the  $\Phi$  based time expansion from smaller to larger pentagrams. That expansion forecasts when time cycle patterns etched on a smaller pentagram are due to repeat on a larger pentagram.

Calculating the expected date for a market pattern to repeat is primarily for academic or intellectual reasons. An experienced trader would never trade a forecast until he had received confirmation that his analysis was correct. That general rule not only applies to this analysis but to any timing technique. From the traders perspective all he really needs to know is that markets repeat for decades with remarkable accuracy every 67-71 years. The trader can make his forecasted date of expected repetition but he should always wait until a considerable amount of it has unfolded before trading that forecast. For example, Chart 10.3 shows that the current market has matched the prior section for at least 15 years. The exact start date is academic.

Three circumscribed Uranus pentagrams are shown below on a two-dimensional plane. Moving counter-clockwise, the middle pentagram defines five 17-year cycles from 1897 to 1982, or one complete 84-year Uranus cycle.

The inner pentagram represents the five mid-cycle turns from 1906 to 1973. The outer pentagram marks the mid-cycle turns, including the panic of 2007-2009.

Figure 10.11

3-dimensional pyramid of Figure 10.12

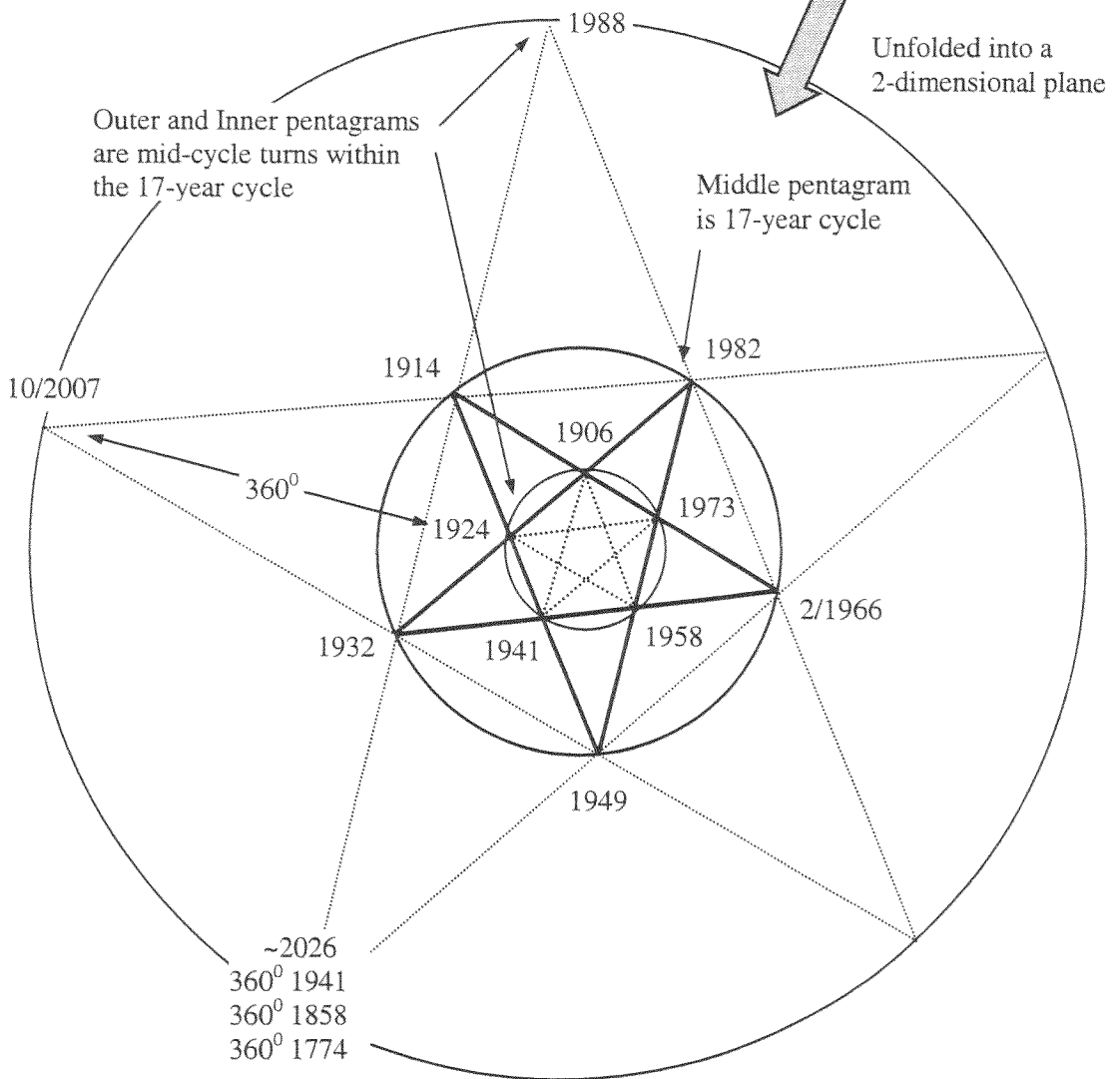
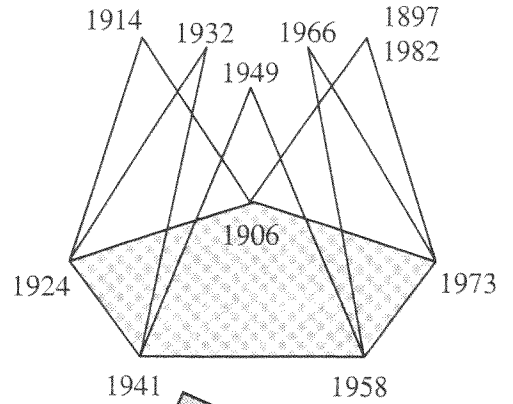
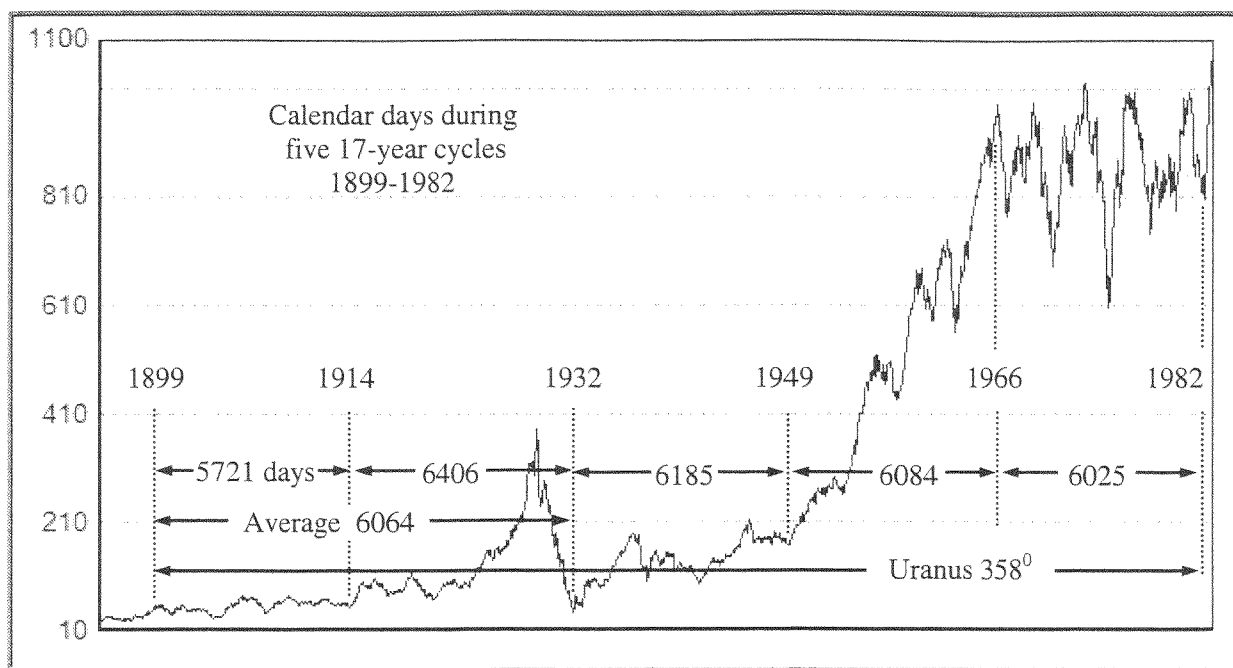


Figure 10.12

Uranus pentagonal expansion of stock market energy levels



**Chart 10.1**

Calendar days of five 17-year cycles in monthly DJIA, 1899-1982.

Just as the periods of the planets were shown to expand by multiples of the  $\Phi$  ratio, so does the time expansion between repeating market patterns. Accurate time measurements must first be made of past 17-year cycles because that gives the side length of the smaller pentagon, which is the base for the pentagonal time expansion to the larger pentagram.<sup>35</sup>

Five 17-year cycles completed between 4/25/1899 and 8/9/1982. During this time Uranus moved  $358^\circ$ . The number of calendar days between these dates was 30,421. One fifth of this value is 6,084 days, or 16 years 7.9 months, representing the

average number of calendar days for the five 17-year cycles from 1899 to 1982. The specific number of days per cycle was:

4/24/1899 to 12/24/1914	= 5,721 days
12/24/1914 to 7/8/1932	= 6,406 days
7/8/1932 to 6/14/1949	= 6,185 days
6/14/1949 to 2/9/1966	= 6,084 days
<u>2/9/1966 to 8/9/1982</u>	<u>= 6,025 days</u>
Total 1899 to 1982	= 30,421 days

$$\frac{30,421}{5} = 6,084 \text{ days}$$

The 1914 market close caused some difficulty when comparing cycles before and after that date. It helps to average the two cycles 1899-1914 and 1914-1932 to 6,064 days.

This compares with an average of 6,115 days for 1/5 of the Uranus cycle during this time. Table 6.1 shows the actual number of

<sup>35</sup> It is helpful to have software or a website to calculate calendar days between two dates. This analysis used CycleTimer and double-checked the results online at [www.timeanddate.com](http://www.timeanddate.com). A web search for "time date calculator" will provide many similar options.

calendar days for two complete Uranus cycles was 61,154.53 days. Dividing half of this value by 365.24 days/year produces a Uranus period of 83.72 years. One fifth of this period is 6,115 days = 16.74 years = 16 years 8.8 months.

Uranus period between 1914-2082 =

$$\frac{61,154.53 / 2}{365.24} = 83.72 \text{ years}$$

Average Uranus time during 72<sup>0</sup> cycles =

$$\frac{83.72 \text{ years}}{5} = 6,115 \text{ days}$$

If the Uranus cycle is measured for many complete cycles it averages 84.01 years, one fifth of which is 16.80 years.

The pentagonal model of time expansion uses these time counts to forecast recurrent market patterns. The analysis will show which sections have repeated in the past and why they repeat after a specific time interval. This will provide the tool for forecasting stock market periodicity.

### **THE 1924-1939 MARKET PATTERN REPEATED IN 1994-2009**

*Four-Dimensional Stock Market Structures And Cycles* built a cube in the DJIA spanning 100 years with patterns on corresponding faces repeating with a 67-year periodicity. The two charts from that work are repeated in Chart 10.2.

The highs and lows within the 1869-1884 period matched very closely with 1934-1949 and the 1899-1915 section matched 1966-1982. Since that chart was originally published in September 1993 the periodicity has continued to repeat with amazing similarity. Anyone who had the course and

updated Chart V.D had the stock market laid out for them for the next 16+ years.

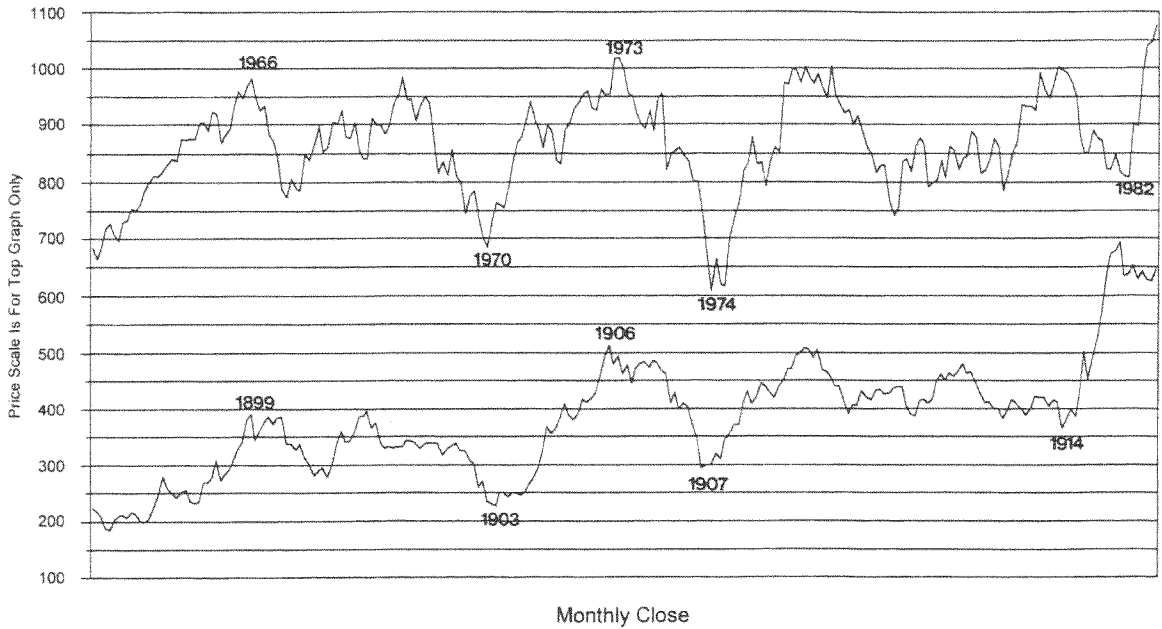
Because people are mostly interested in recent market action the current NASDAQ is compared with its counterpart 70 years earlier. The NASDAQ was chosen because it receives the majority of the speculative stock market money, including the "dot com" boom and bust of 1995-2003. Excesses in human emotion are best recorded in the instrument providing the most speculation. Back in the 1920s the speculative fervor was recorded in the Dow Jones Average. If the current DJIA is used instead of the NASDAQ the timing will be the same, only the magnitudes of the moves are less in the DJIA because it does not represent the majority of speculative money at this time.

The NASDAQ started trading on February 8, 1971 so there is no data for the period 70 years earlier. However, because the speculative money in the 1920s went into the DJIA, a comparison between these two charts is a good reflection of the corresponding speculative human behavior in these two times.

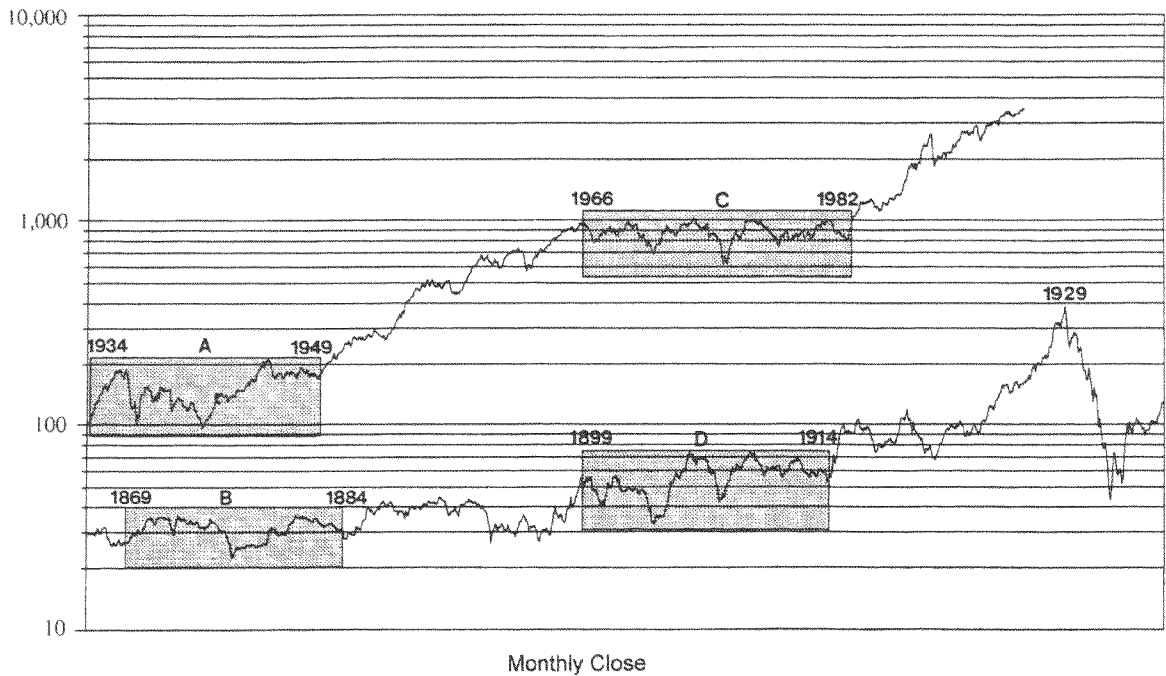
Chart 10.3 overlays the DJIA during the "Roaring 20's" and crash. 1922-1939, with the corresponding NASDAQ 70 years later, 1992-2009. Both sections followed the 13-year time cycle pattern, 5 years up – 3 years down – 5 years up. Keep in mind that markets rarely move more than five years in one direction without a reversal because, as WD Gann wrote in his *Master Courses*, the 5-year cycle represents a complete cycle.

Pentagonal time cycle theory explains why 70 years separated these two market sections from 1924 to 1994. It also explains why the 1899 to 1966 sections were separated by 67

**V.E**  
SQUARES C AND D FROM CHART V.D

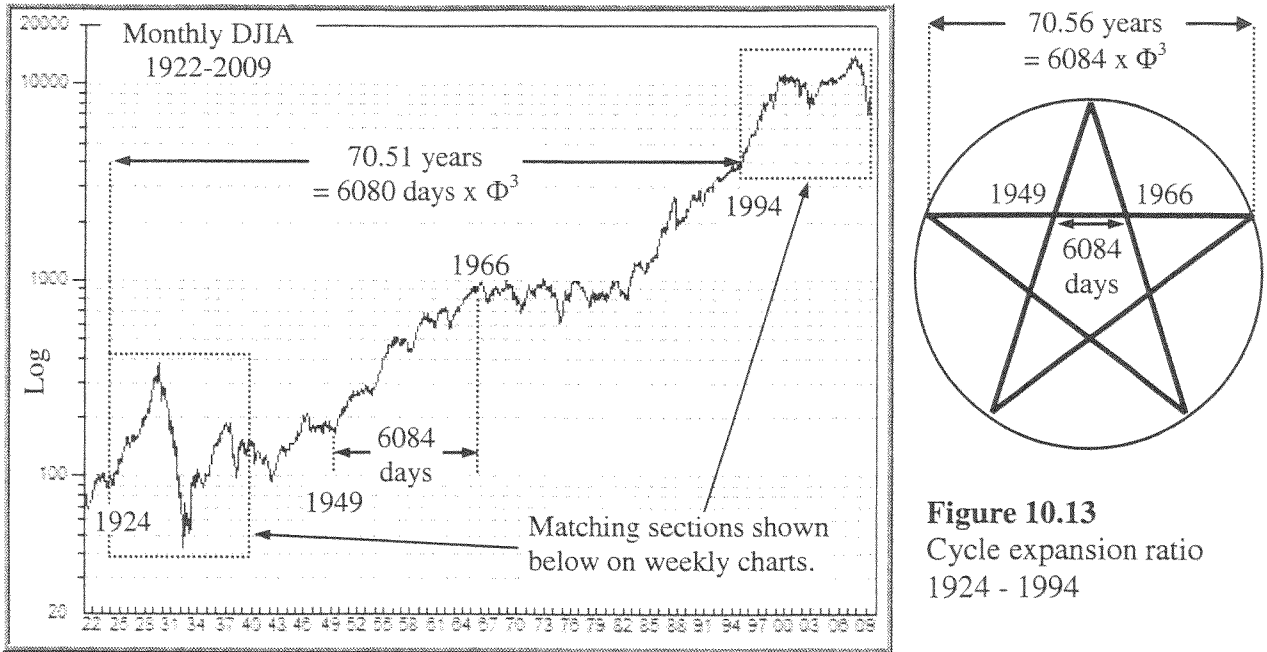


**V.D**  
CORRESPONDING SQUARES OF TWO CUBES

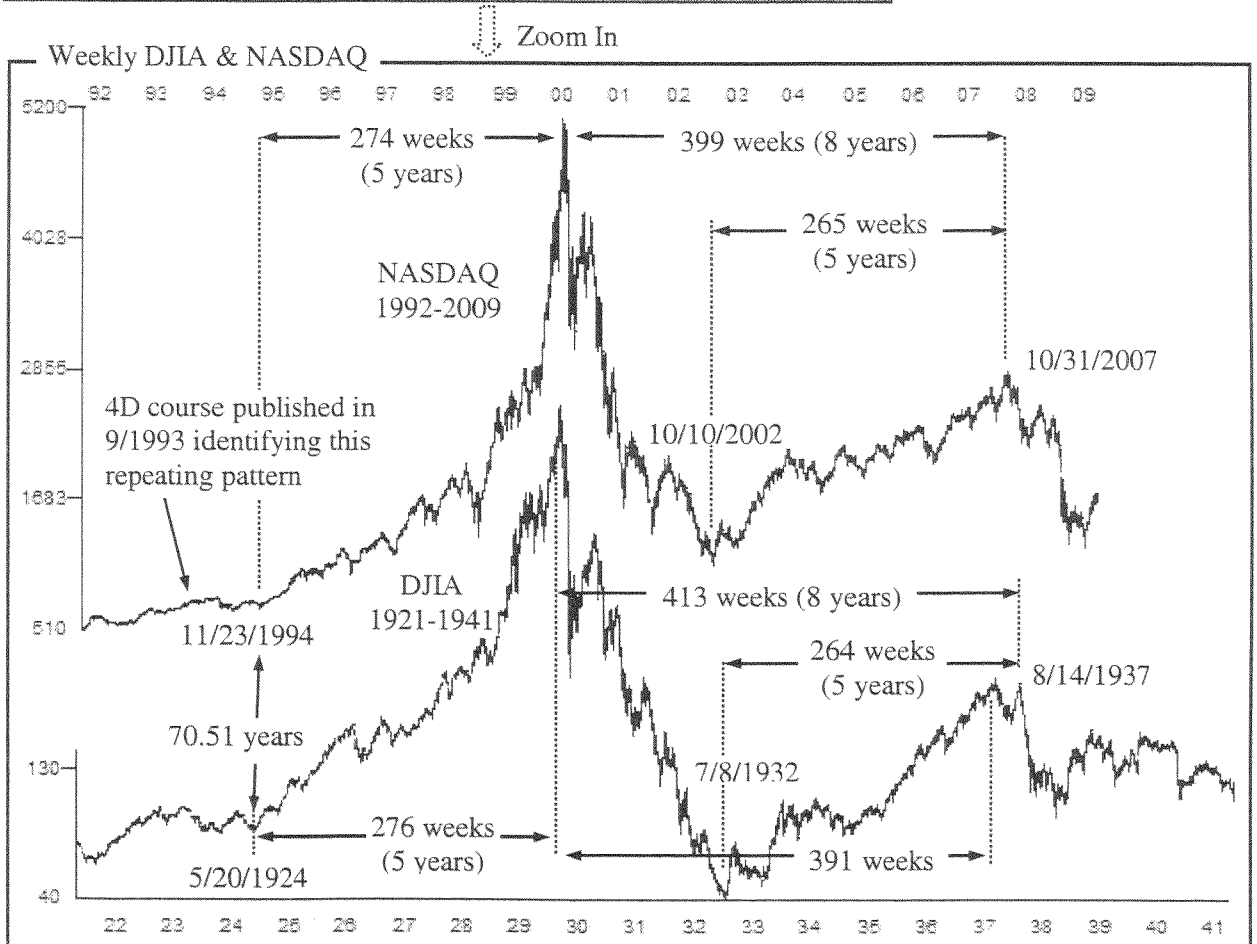


**Chart 10.2**

67-year periodicity. Reprinted from *Four-Dimensional Stock Market Structures And Cycles*.



**Figure 10.13**  
Cycle expansion ratio  
1924 - 1994

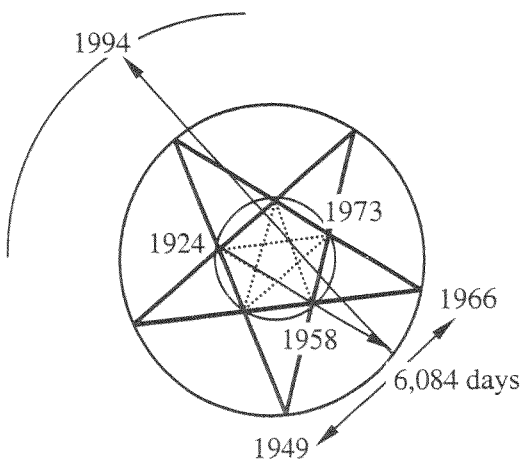


**Chart 10.3**  
Comparison of weekly NASDAQ 1991-2009 with DJIA 1921-1939.

years, and why the 1859 to 1924 sections were separated by 65 years.

Figure 10.2 showed the span of the unfolded arms of a pentagram is  $\Phi^3$  multiplied by the side of the inner pentagon, which in this case is the 17-year cycle. The periodicities of time cycles repeat with this same  $\Phi^3$  expansion factor. The duration of a time cycle multiplied by  $\Phi^3$  defines its periodicity, or the time that expires before the cycle pattern repeats.

Figure 10.12 showed how three expanding pentagrams defined the timing of the 17-year cycles and their mid-cycles. Figure 10.14 is a compressed view of that figure.



**Figure 10.14**  
Pentagonal time expansion, 1924-1994.

The smallest pentagram at the center contains three major mid-cycle points (1924-1958-1973) in a Golden Triangle with 1924 at the apex. The 1924 to 1958 side of the triangle points at the 1949-1966 section on the next larger pentagram. The duration of this 1949-1966 section was 6,084 calendar days.

Using 6,084 as the side of the pentagon and multiplying by  $\Phi^3$  to arrive at the span of the next larger pentagram produces the time expansion shown in Figure 10.13.

$$\begin{aligned} \text{Pentagonal Time Expansion} &= \\ 6,084 \times \Phi^3 &= 25,771 \text{ days} = 70.56 \text{ years} \end{aligned}$$

Adding this time expansion to the start of the mid-cycle bottom on May 20, 1924 gives the date when the pattern begins to repeat at the mid-cycle bottom on November 23, 1994. Chart 10.3 overlays these two time periods, 1994+ in the NASDAQ and 1924+ in the DJIA.

The actual time from the start of the 5-year cycle in 5/20/1924 to the start of the 5-year cycle in 11/23/1994 was 70.51 years, which equals  $6,080 \text{ days} \times \Phi^3$ .

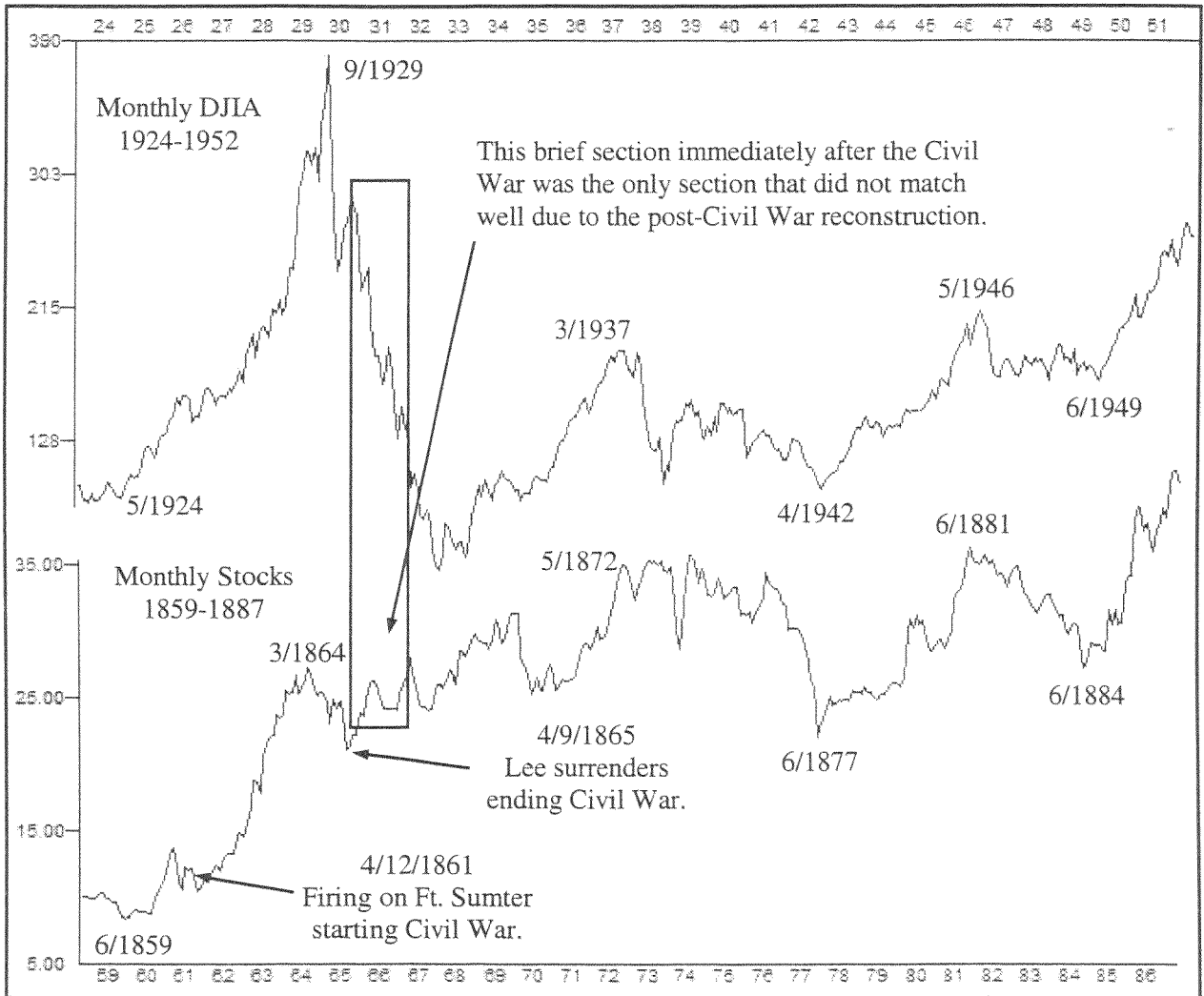
$$70.51 \text{ years} = 6,080 \text{ days} \times \Phi^3$$

6,080 days differs from the side of the 1949-1966 pentagon by only four days (6,084).

**THE 1859-1886 MARKET PATTERN REPEATED IN 1924-1951**

The 1924+ section of market that matched so well with 1994+ repeated a third time, 65 years before 1924. Chart 10.4 compares 1859-1886 with 1924-1951. Both periods followed the same yearly time cycle pattern, 5-3-5-5-4-3. As in 1924-1929 and 1994-2000, the biggest up-move was during the 5-year cycle at the beginning, 1859-1864, in this case coinciding with the Civil War.

Both time periods were highly volatile in USA history. The 1859-1886 period began with the Civil War that decimated the south and the following reconstruction. 620,000+ lives were lost including nearly 25% of the soldiers from the south, more than all other



**Chart 10.4**

Repeating market patterns 1924-1952 and 1859-1887.

American wars combined. When the war ended in 1865 the south was destroyed. Sherman had burned much of it to the ground, especially South Carolina, which was seen as the starting point of the rebellion. After the war, industry in the south was effectively nonexistent, providing a great boom for industries in the north that remained functional.

Chart 10.4 shows the reconstruction period enclosed in a box with the corresponding volatile crash 65 years later in the 1930s.

The argument could be made that without the massive post-war stimulus to business due to reconstruction the cyclic conditions would have driven stock prices much lower during the 1864-1867 down cycle.

The exact date of tops and bottoms prior to 1885 is unknown because there was no daily stock market data recorded during that time. The lack of data makes the technique of measuring daily time cycles and multiplying by  $\Phi^3$  impossible because too much error is possible when the daily time count can be



off by as much as a month. Therefore, this analysis of the three matching sections will focus on their common patterns and composition.

Chart 10.5 shows that all three sections began at mid-cycle acceleration bottoms with a 13-year cycle that subdivided into a 5-3-5 pattern. The first 5-year cycle was the largest bull move during the entire 25-year period, 1859-1864, 1924-1929, and 1994-1999.

Both the 1924-1949 and 1859-1884 sections followed the yearly 5-3-5-5-4-3 pattern beginning with an 8-year cycle following a 5-3 pattern and ending with a 17-year 5-5-4-3 pattern.

Four 17-year cycles, or 67 years, back in time from 1859 was the birth of the NYSE in 1792. Figure 10.15 provides a graphical view of this 67-year periodicity by plotting all three matching sections on 67-year concentric circles. This figure shows how all three sections are the same arcs of the 67-year circle only at higher energy levels, further away from the 1792 center.

The duration of each matching section was 25+ years, or  $1\frac{1}{2}$  17-year cycles, or 2 "Mark of the Beast" cycles of 12.8 years. The center of the circles is the birth of the NYSE in 1792 with the signing of the Buttonwood Agreement. 67 years after 1792 was the first recurrence in 1859, then another 65 years until it repeats in 1924, and another 70 years until 1994. The total time from 1792 to 1994 is 202 years, or 3x's 67 years, or 4 periods of Jubilee.

Figure 7.2 showed that the 67-year period corresponds with Saturn-Uranus completing four  $135^0$  cycles of 17 years. Eight  $135^0$  cycles totaling 135 years are necessary for Saturn-Uranus= $135^0$  to return to its original

starting point. The average displacement of Uranus during 135 years is  $\sim 576^0$ , the fourth Square of Twelve. 135 years from 1859 was the corresponding matching mid-cycle bottom in 1994. The 2000 "dot.com" speculative blow off top was 135 years from the end of the Civil War in 1865. Compare Chart 10.5 with Figures 7.2 and 7.3 for a better understanding of how Saturn-Uranus and Uranus movements correspond with these 67 and 135-year periodicities.

### ***THE 1897-1915 MARKET PATTERN REPEATED IN 1964-1983***

The previous section showed that since the 1792 birth of the NYSE a 25-year pattern has repeated every  $\sim 67$  years. That leaves 42 years of the 67-year periodicity not within those matching sections. As will now be shown, there are additional repeating patterns in this remaining 42 years that also have a 67-year periodicity.

On February 9, 1966 the 17-year up-trend that had been in place since 1949 clearly reversed. For the next 17 years the market moved sideways with a volatile choppy action. Chart 10.6 matches the 1966-1983 section with its counterpart 67 years earlier in 1899-1915.

Figure 10.17 shows that these 17-year sections are on the opposite side of the 67-year circle than the previous 25-year matching sections. Because the previous matching sections lasted 25 years and this is 17 years, 42 of the 67-year cycle match very closely using only two patterns. That is  $\frac{2}{3}$  of the total. The remaining unshaded areas of the figure are mostly in dramatic up moves, such as 1949-1962 and 1982-1994.

Because daily data is available for the 1899-1915 section, the pentagonal time expansion between these two cycles can be calculated.

These three sections match with a 67-year periodicity. The origin is the birth of the NYSE in 1792. Every ~67 years thereafter this market pattern has repeated. The bottom two sections matched for 28 years. The top chart unfolded after the matching pattern was first published in 1993.

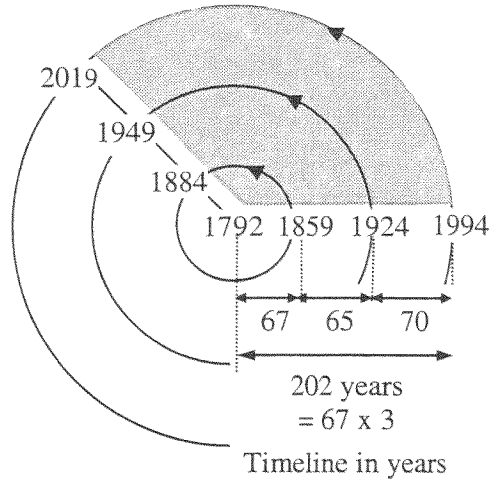
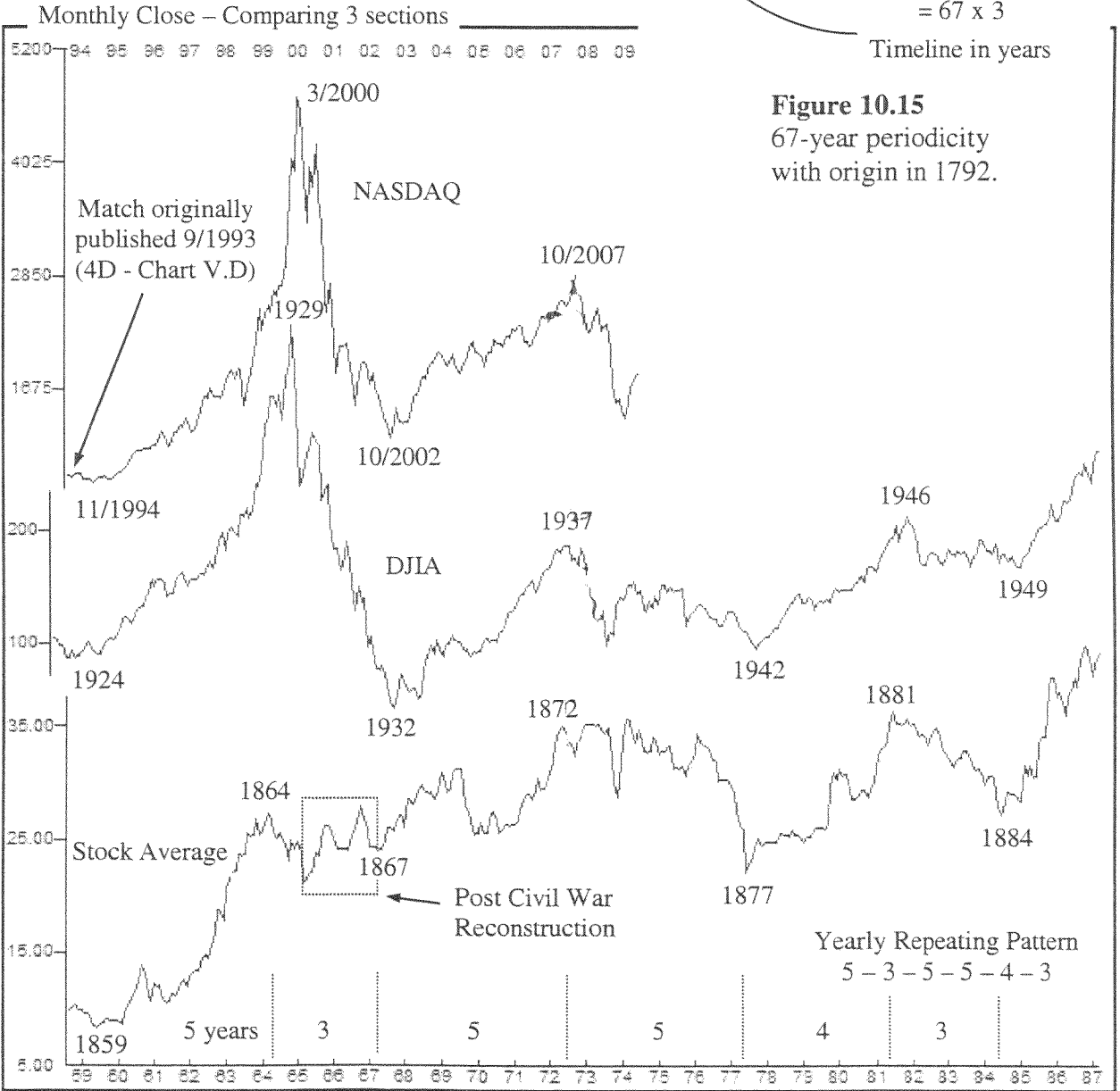


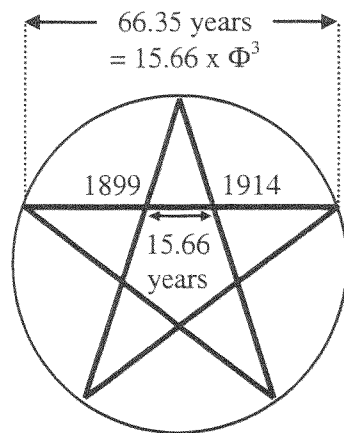
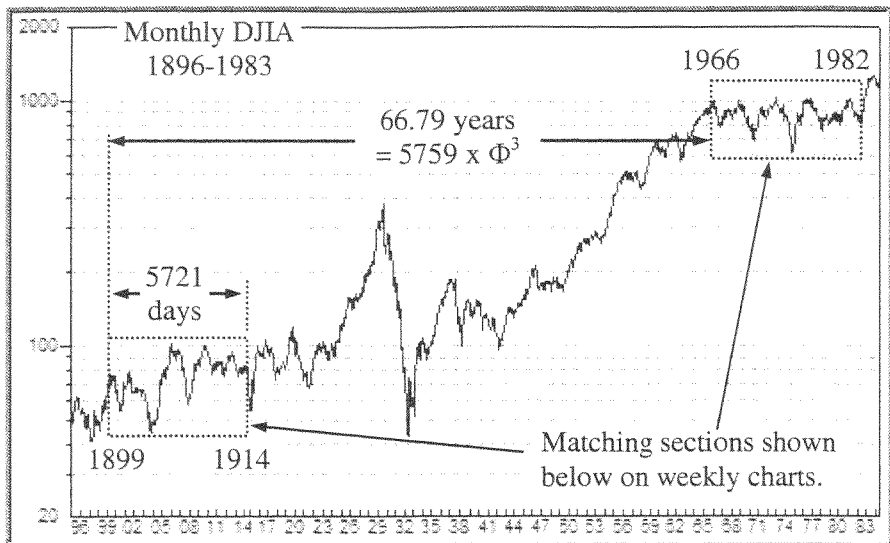
Figure 10.15 plots all three cycles on a circle of 67-years. The shaded area shows the matching sections.



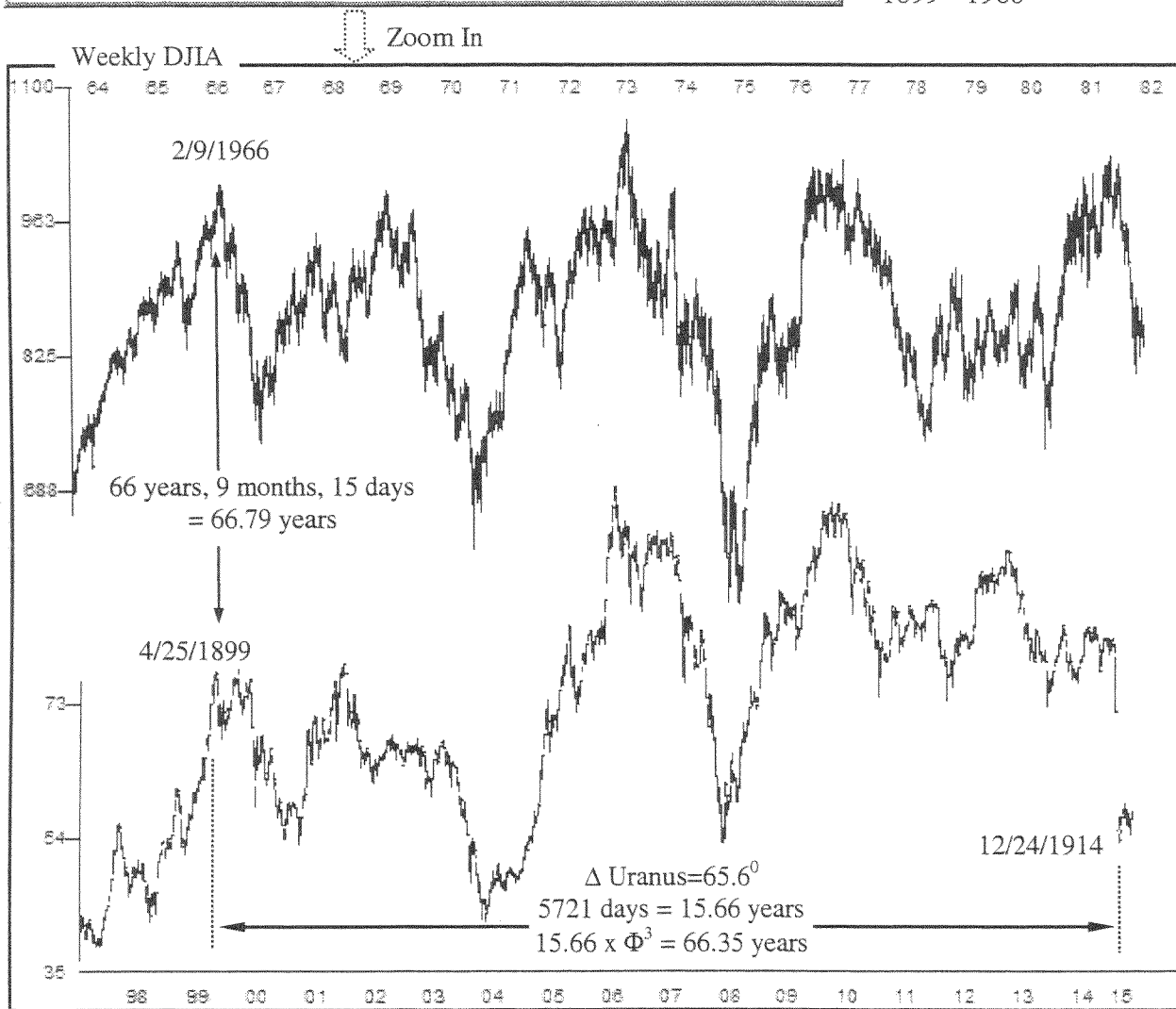
**Figure 10.15**  
67-year periodicity with origin in 1792.

**Chart 10.5**

Three matching market sections. Bottom two sections matched for 28 years.



**Figure 10.16**  
Cycle expansion ratio 1899 - 1966



**Chart 10.6**

Repeating market sections 1897-1915 and 1964-1982 separated by  $\Phi^3$ .

The duration of the 1899-1914 down cycle is measured and multiplied by  $\Phi^3$ . The result is added to the 4/25/1899 top to project the repetition date.

There were 5721 calendar days between 4/25/1899 and 12/24/1914. 12/24/1914 was the actual low shortly after the market reopened in 12/12/1914.

Projected pentagonal time expansion =  
 $5721 \times \Phi^3 = 24,233 \text{ days} = 66.35 \text{ years}$

The actual time between the start of the two matching sections was,

$$\begin{aligned} 4/25/1899 \text{ to } 2/9/1966 &= 24,396 \text{ days} \\ &= 66.79 \text{ years} \end{aligned}$$

Chart 7.9 showed that many of the major turns in these two sections were also closely separated by  $\Delta \text{ Saturn-Uranus} = 540^0$ .

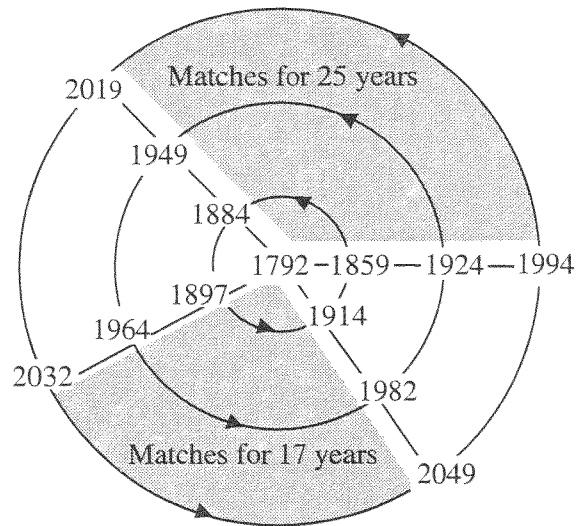
### URANUS PENTAGONAL EXPANSION BETWEEN REPEATING PATTERNS

The  $\Phi^3$  time expansion ratio has been used to project when a market pattern is expected to repeat. The number of expired days during a 17-year cycle was multiplied by  $\Phi^3$  and the result used as the time expansion factor. This same  $\Phi^3$  expansion ratio is used with Uranus to forecast the same recurrence date.

Figure 10.3 illustrated the one-to-one relationship between the  $72^0$  inner angle of the Uranus pentagram and the 72 years spanned by its unfolded arms, given by multiplying the 17-year pentagon side by  $\Phi^3$ .

Span of extended Uranus pentagram =  
 $17 \text{ years} \times \Phi^3 = 72 \text{ years.}$

A relationship of  $72^0 = 72 \text{ years}$  exists for that pentagram, one degree equals one year



**Figure 10.17**

67-year periodicity with the origin at the 1792 birth of NYSE.

in the time expansion ratio.<sup>36</sup> It is the extended pentagram calculated by  $\Phi^3$  that gives the separation in time between repeating market patterns.

This same one-to-one relationship exists between the movement of Uranus during a 17-year cycle and the time expansion between repeating patterns. For example, the  $\Delta \text{ Uranus}$  from the 5/20/1924 mid-cycle low to the 12/7/1941 mid-cycle attack on Pearl Harbor was  $70.25^0$ . In addition,  $\Delta \text{ Uranus}$  during the 17-year cycle 7/8/1932 to 6/14/1949 was  $70.33^0$ . Both of these values closely match the time value of 70.51 years separating the 1924 to 1994 repeating patterns, shown in Chart 10.3.

<sup>36</sup> WD Gann used a one-to-one relationship of planetary movement with price and time in *May Coffee Santos*, written in May 1954, republished in the *Rare Writings of WD Gann*.

Chart 10.6 shows another example of Uranus time expansion connecting repeating patterns. Between 4/25/1899 and 12/24/1914 Uranus move  $65.6^\circ$ , which is about one degree less than the 66.79 years separating the 1899-1915 to 1966-1982 repeating patterns. Again, this is a one-to-one relationship between the angular displacement of Uranus, or the inner angle of the pentagram, and the time expansion or span of the unfolded pentagram.

Appendix G,  $\Phi^3$  *Pentagonal Expansion of Planetary Cycles*, shows a similar approach to predict starting dates of repeating patterns by advancing the planets by a  $\Phi^3$  multiple.

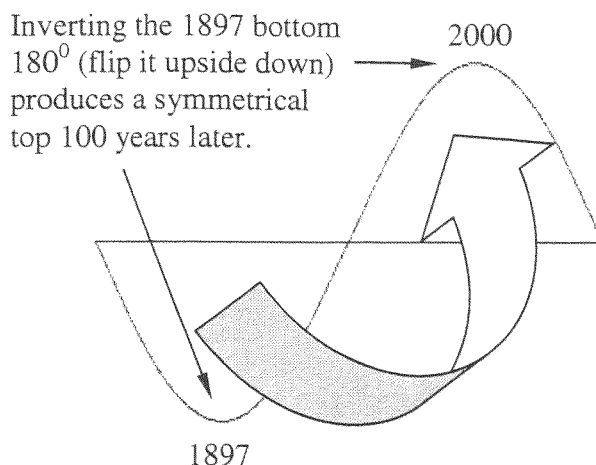
### MARKET SYMMETRY OFTEN CAUSES INVERTED PATTERNS TO MATCH

Market symmetry is a topic that would require an entire book to fully explore. This book has already investigated many aspects of this analysis, such as recurring patterns and the corresponding pentagonal arrangements of the planets. As planetary patterns repeat, so do market cycles.<sup>37</sup>

Symmetry is not limited to recurring patterns. It is also present with inverted patterns matching cycle tops/bottoms with later bottoms/tops. This fascinating aspect of cycle symmetry shows that the internals are similar in both the bull and bear phases. In other words, if you flip a 5-year bear cycle upside down its internals often match a 5-year bull cycle.

In its simplest form a market cycle can be modeled by a sine wave. Although this is not the real-life form of market cycles, it helps as an academic tool to simplify the arrangement of market symmetry. Figure

<sup>37</sup> This introduces a new topic of *Pentagonal Market Symmetry* that may be the subject of future writings.



**Figure 10.18**

Inverted pattern at bottom matches a later top.

10.18 shows the areas in the 1897-2000 cycle where inverted bottoms would be symmetrical with later tops.

Chart 10.7 shows the 1899-1904 bear cycle upside down so the tops become bottoms and bottoms become tops. Above the inverted chart is the most recent 5-year cycle 2002-2007. 2002 was two periods of Jubilee, or six 17-year cycles, from 1899 ( $17 \times 6 = 102$  years). The turning point in these two cycles match very closely.

Chart 10.8 extends this comparison for fifteen years, showing how closely the 1994-2009 period matched its inverse in 1892-1907.

The 5-year bull cycles in Figure 8.15 and the 5-year bear cycles in Figure 8.14 are good cycles to practice this concept of matching inverted patterns.

Chart 10.9 shows the inverted 1899-1904 5-year bear cycle compared to the 1932-1937 bull cycle. These two cycles are separated by two 17-year cycles.

# TRADING SOFTWARE

***FOR SALE & EXCHANGE***

**[www.trading-software-collection.com](http://www.trading-software-collection.com)**

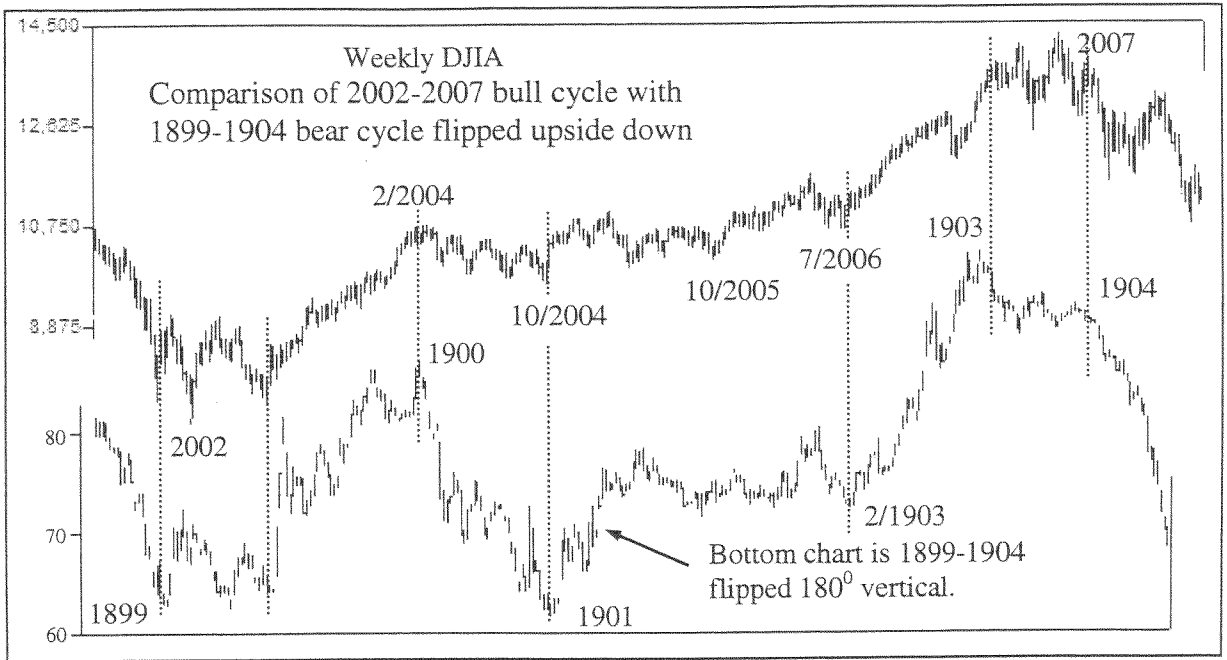
**Subscribe for **FREE** download 5000+ trading books.**

## **Mirrors:**

**[www.forex-warez.com](http://www.forex-warez.com)**  
**[www.traders-software.com](http://www.traders-software.com)**

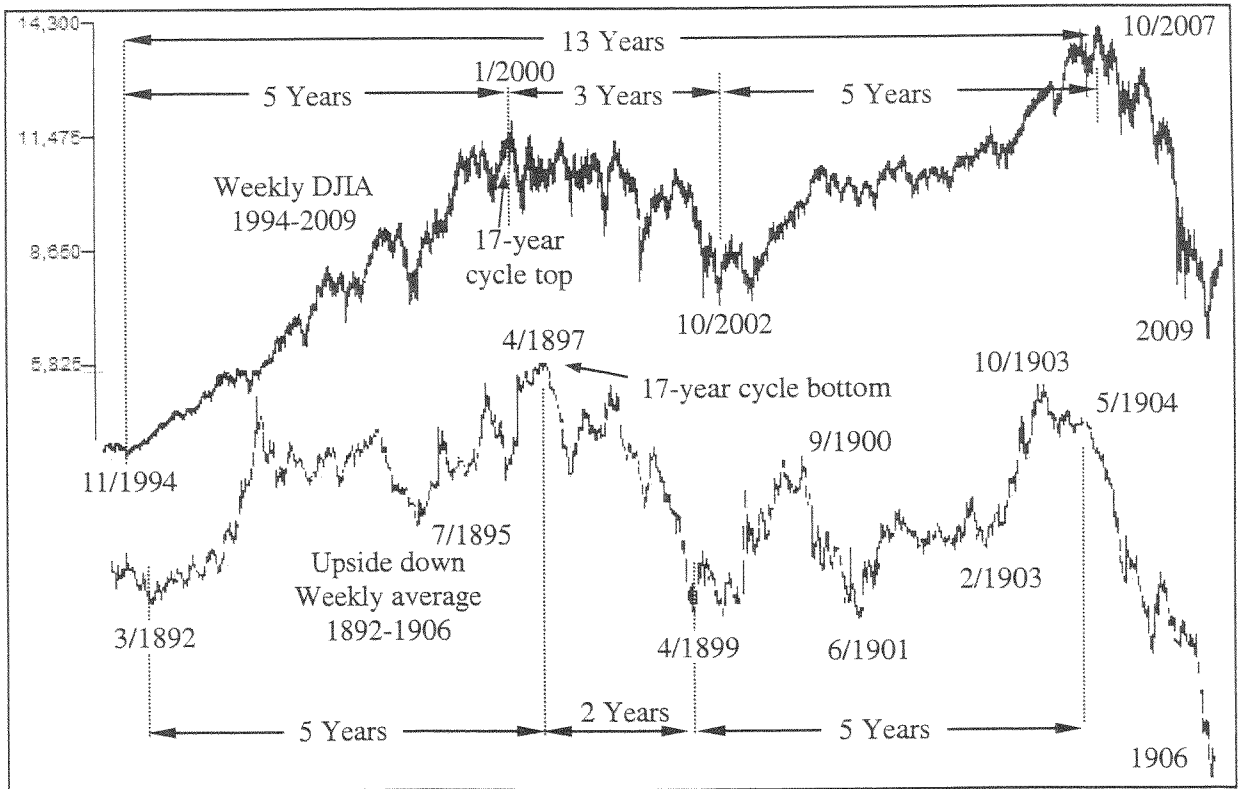
## **Contacts**

**[andreybbrv@gmail.com](mailto:andreybbrv@gmail.com)**  
**[andreybbrv@hotmail.com](mailto:andreybbrv@hotmail.com)**  
**[andreybbrv@yandex.ru](mailto:andreybbrv@yandex.ru)**  
**Skype: andreybbrv**  
**ICQ: 70966433**



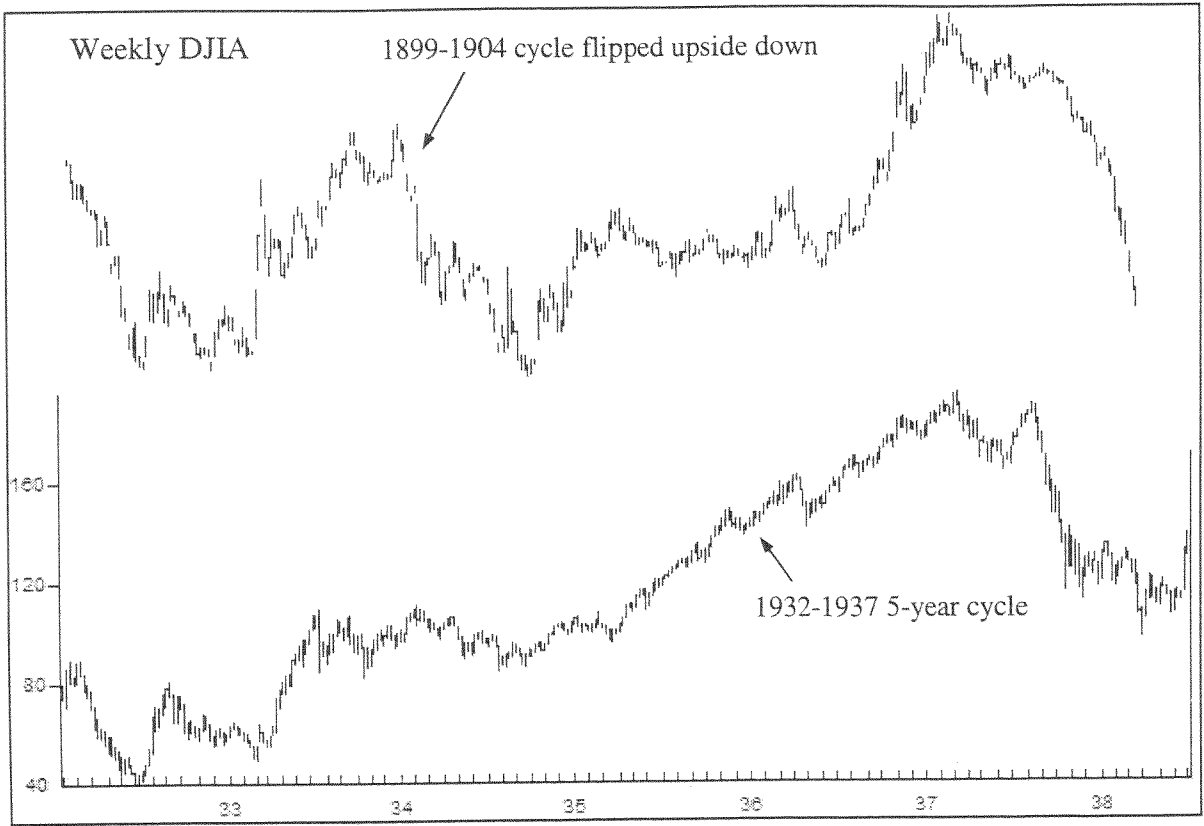
**Chart 10.7**

Comparison of 2002-2007 with inverse of 1899-1904 (flipped upside-down).



**Chart 10.8**

Comparison of 1994-2009 with inverse of 1892-1906 (flipped upside-down).



**Chart 10.9**

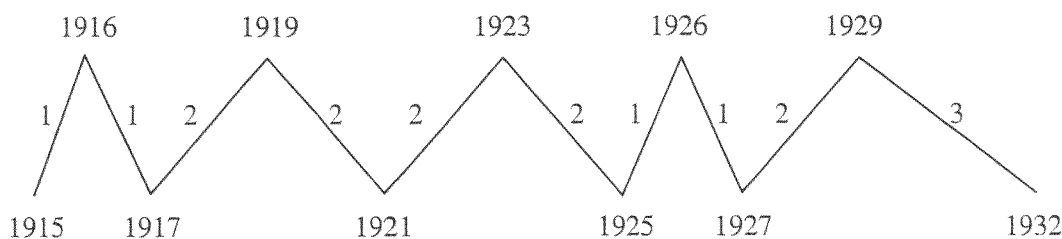
Inverse of 1899-1904 5-year cycle compared with 1932-1937 cycle.



People are often more interested in the latest recently published material and lose touch with some of the good work written years ago. WD Gann, RN Elliott, James Langham et al., wrote some of the best books on market analysis in the 1930s. Most of their books have gotten a lot of attention over the years and do not risk being forgotten, especially those of Elliott and Gann. However, there are other good works that should not be forgotten and merit a place in any serious market analyst's library.

Cogan's 1969 book *Rhythmic Cycles of Optimism and Pessimism* is one such book. Less than 60 pages in length the book presents the concept of recurring patterns or periodicity in the stock market. This periodicity results in a 17-year repeating pattern that Cogan tried to model with a 10-wave composite with both positive and negative phases.

It is not the intent of this author to prove or disprove the merits of Cogan's work. Rather, the goal is to preserve it, and to shed light on some confusing areas. Some original charts are difficult to see so they are redone and new figures are drawn to clarify a few topics.



**Figure 11.1**

Cogan's 17-year periodicity with constant amplitudes.

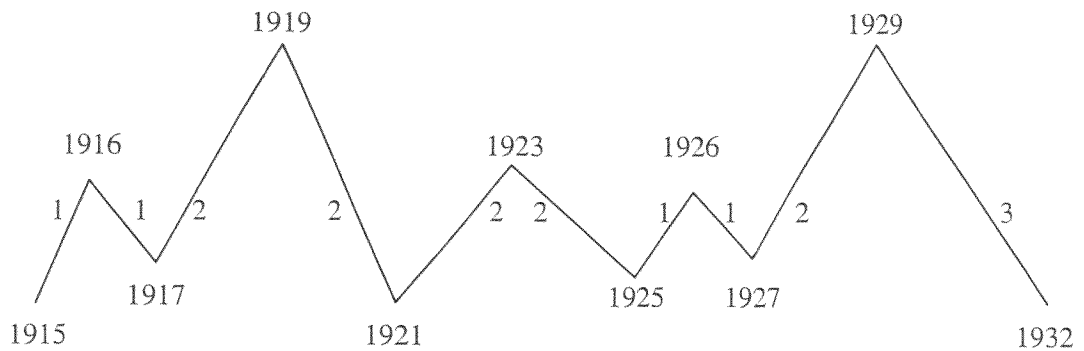
Ultimately, the reader must decide if Cogan's work adds value to his personal style of research and analysis.

The natural inclination of readers of this material is to match Cogan's cycle components with planetary cycles. The  $180^{\circ}$ - $216^{\circ}$  Saturn cycle,  $180^{\circ}$  Uranus mid-cycle panics and acceleration bottoms, the 666-week cycle, Gann's 2-1-2 five-year pattern all provide good insight into these components.

Cogan's work used only yearly stock market data, providing a starting point for general analysis, but is not very precise when trying to match market cycles with planetary cycles. Even the slow moving Uranus travels four or five degrees in one year.

### **COGAN'S 17-YEAR STOCK MARKET PERIODICITY**

At the heart of Cogan's work is the 17-year market periodicity. He adds ten triangle waves together creating a composite. When the amplitudes of all components are the same the result is the following pattern of highs and lows.



**Figure 11.2**

Cogan's 17-year periodicity with different amplitudes showing 10-year tops.

At the end of the pattern it repeats unless the cycle inverts, then the pattern is flipped upside down.

When the amplitudes of the cycles are changed to reflect bigger moves at certain times the result is a pair of price spikes 10 years apart, in the above example 1919 and 1929. Major bottoms also occur six and eleven years apart, 1915-1921 and 1921-1932.

Cogan's 17-year cycles have been:

1898 – 1915	(bottom to bottom)
1915 – 1932	(bottom to bottom)
1932 – 1949	(bottom to bottom)
1949 – 1966	(bottom to top)

Because Cogan's book was published in 1969, the cycle dates after 1969 are this author's updates made by simply adding 17 years without regard to phase.

1966 – 1983	(top to bottom)
1983 – 2000	(bottom to top)
2000 – 2017	

The model is not as simple as just drawing a repeating pattern of tops and bottoms every 17 years because Cogan also includes positive and negative phases where all cycle components reverse. Cogan's Chart I shows the model in positive phase between 1888

and 1951 then reversing to negative phase in 1951. It stayed in the negative phase during the entire 1951-1966 bull market until reversing again to positive phase in 1966. Do not confuse a "positive phase" with an up trend.

### ***EXAMPLES OF COGAN'S 17-YEAR PERIODICITY***

Chart 11.1 shows three recurrences of the 17-year periodicity in the positive phase that occurred before Cogan's book was published, 1898-1915, 1915-1932, and 1932-1949. His periodicity with amplitude tendency is overlaid on the charts, showing a reasonably good match. A few data points are off by a year such as the model's 1925 bottom that actually arrived in 1924 and the 1936 top that arrived in 1937. Overall, the pattern works well during these three positive phase cycles.

According to Cogan's model, the pattern reversed to "negative phase" in 1951 during the massive bull market from 1949-1966. Chart 11.6 shows the cycle in the inverse or negative phase during 1950-1966. It is the same as the model in the positive phase except that it is flipped upside down, or inverted 180° vertically.

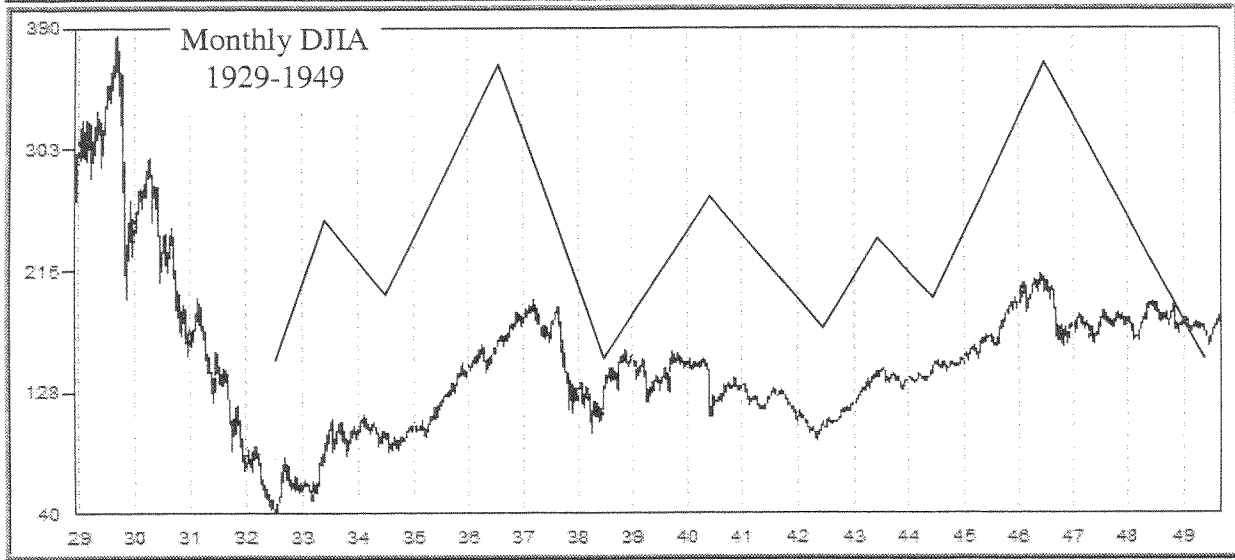
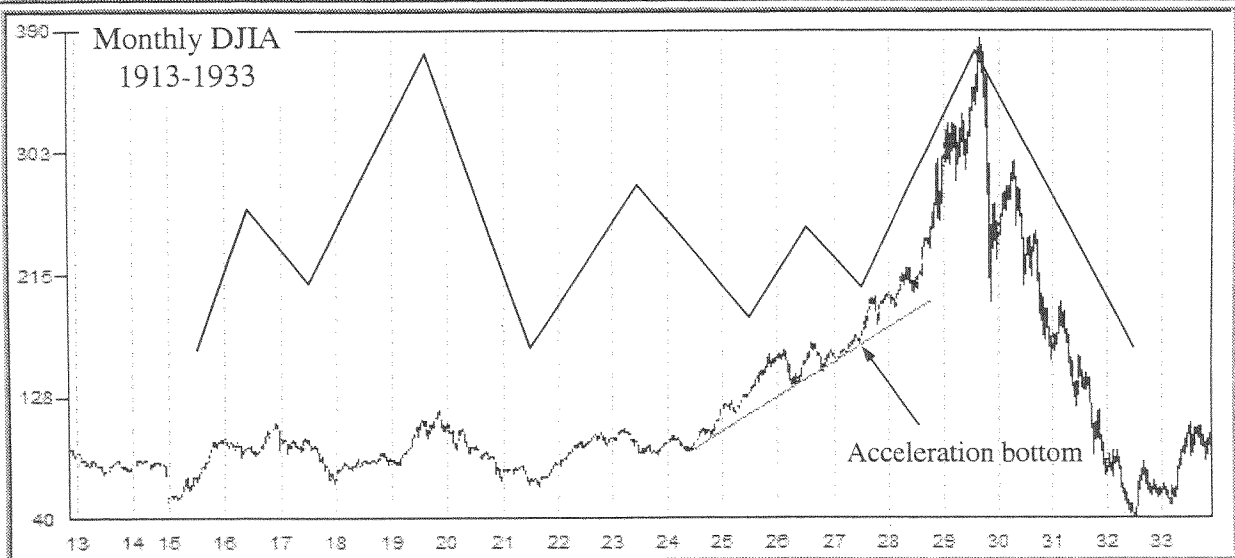


Chart 11.1

Three examples of Cogan's 17-year periodicity, 1898-1949, all in "positive phase".

### CREATING A 10-CYCLE COMPOSITE WITHOUT USING A COMPUTER

Chart VI in Cogan's book can be very confusing at first glance. He broke down the 17-year cycle into a composite of ten triangle waves. The first five (A1-A5) slowly ramp up for 14-16 years then drop for 1-3 years. The other five (B1-B5) slowly ramp down for 15-16 years then rise for 1-2 years. These cycles reverse when the polarity changes to the negative phase. Cogan's 10 cycles are summarized below in Table 11.1.

The easiest way to create a composite of waveforms is to sum the data using a spreadsheet such as Excel or QuatroPro. This works well but does not provide much insight into what is happening with the simple components.

A better understanding of these components is gained by creating the composite without a computer using a simple trick taught in

most first year engineering schools. When the cycles are grouped together into pairs, one from group A with one from group B, they cancel each other out except at one location. Applying this simple technique, a composite of the ten cycles can be easily created.

For example, Cogan's Chart VI shows that A1 and B4 bottom on the same dates, 1900, 1917, 1934, etc. Similarly, all the simple cycles in A have a corresponding cycle in B with the same bottom date.

1. A1 and B4 bottom in 1900, 1917, 1934, 1951, etc.
2. A2 and B3 bottom in 1898, 1915, 1932, 1949, etc.
3. A3 and B1 bottom in 1891, 1908, 1925, 1942, 1959, etc.
4. A4 and B5 bottom in 1887, 1904, 1921, 1938, 1955, etc.
5. A5 and B2 bottom in 1893, 1910, 1927, 1944, 1961, etc.

Positive Phase		
Cycle #1 -	16 years up 1 year down	} A1-A5 in Cogan's Chart VI
Cycle #2 -	14 years up 3 years down	
Cycle #3 -	15 years up 2 years down	
Cycle #4 -	15 years up 2 years down	
Cycle #5 -	16 years up 1 year down	
Cycle #6 -	16 years down 1 year up	} B1-B5 in Cogan's Chart VI
Cycle #7 -	15 years down 2 years up	
Cycle #8 -	16 years down 1 year up	
Cycle #9 -	15 years down 2 years up	
Cycle #10 -	15 years down 2 year up	
Negative Phase - Reverse all above		

**Table 11.1**

Ten simple components of Cogan's 17-year model.

The reason for grouping these cycles together is best shown with an example by adding together the first pair, A1 and B4.

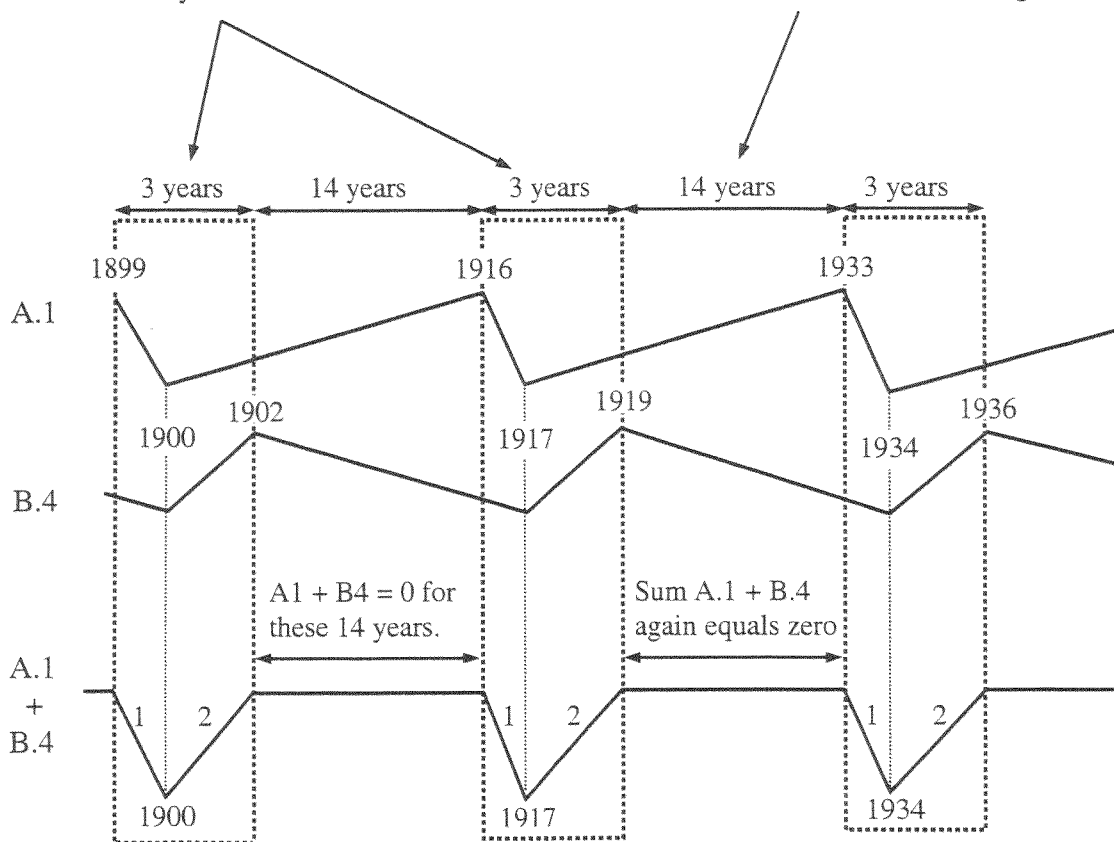
Figure 11.3 shows that 14 years of the 17-year cycle have a net sum of zero because when A.1 is moving up B.4 is moving down canceling each other out. Only during 3 of the 17 years do both cycles move in the same direction producing a sharp down cycle of 1 year followed by 2 years up. This pulse repeats every 17 years.

Figure 11.4 repeats this process for the remaining 8 cycles in Cogan's Chart VI producing 4 more composites with heartbeat style pulses and a 17-year periodicity.

The sum of the five pairs of cycles are shown together in Figure 11.5. The sum is zero where the lines are flat, effectively canceling each other out with one moving up and one moving down. A zero sum composite can be discarded.

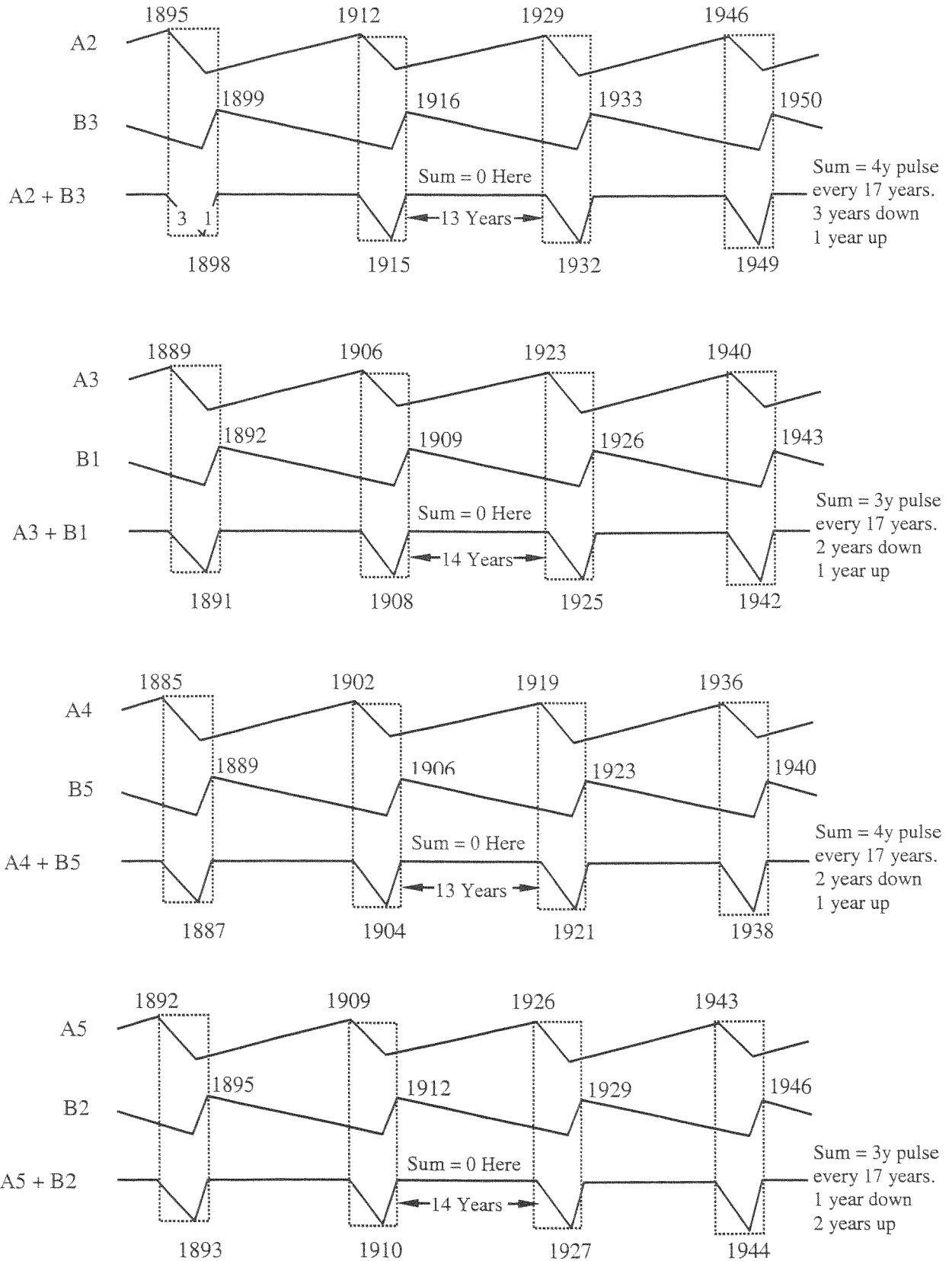
The sum of these two cycles produces a net result for only 3 of the 17 years.

During the other 14 years the cycles are moving in opposite directions and cancel each other out when added together.



**Figure 11.3**

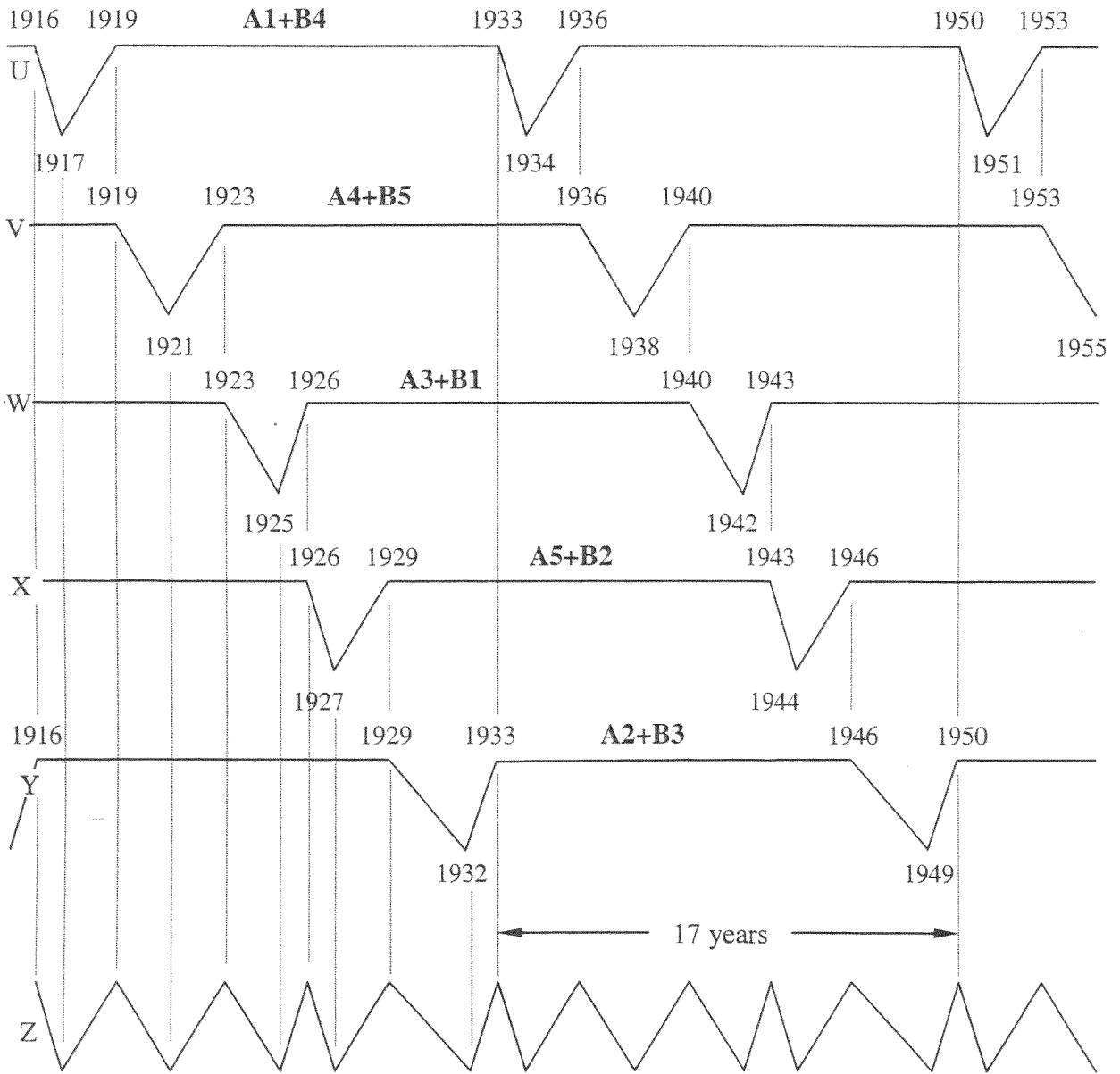
Sum of two of Cogan's cycles produces net result of zero in 14 of the 17 years.



**Figure 11.4**  
Sum of four pairs of Cogan's cycles.

This simplified model assumes all cycles have the same amplitude or energy level. Overlaying the five cycles creates their composite.

The result is shown below at the bottom of Figure 11.5. It is the same as *Figure 1* in Cogan's book.



Sum of above 5 cycles (10 total). Cogan's *Figure 1*.

**Figure 11.5**

Composite of 10 simple cycles, reproducing Cogan's *Figure 1*.

### **INCORPORATING $\Delta$ SATURN= $180^0$ INTO COGAN'S MODEL**

Cogan's model matched the 1898-1949 market better than the more recent data because the data prior to the 1969 publication undoubtedly influenced his choice of simple components. The results can be improved by incorporating some of the knowledge in Gann's Master Courses along with planetary cycles presented in this book and *Four-Dimensional Stock Market Structures And Cycles*.

A few simple planetary cycles that have been proven to work well in timing major turns, such as the  $180^0$  Saturn cycle and the  $180^0$  Uranus mid-cycles, improves the timing of Cogan's model. For example, one fascinating part of Cogan's composite is the 3-year decline at the end of 17-year cycles, 1912-1915, 1929-1932, 1946-1949, and 1979-1982, corresponding with A2+B3 from Figure 11.5.Y.

In each instance the top occurred when  $\Delta$  Saturn= $180^0$  from the start of the 17-year cycle and Uranus had not yet moved the complete  $72^0$  to start a new 17-year cycle, such as 1966-1968. From this top markets plunged by an amount defined by the price increase immediately preceding it. The 1929-1932 drop was the most dramatic because the 1924-1929 cycle was a speculative blow-off. The 3-year drop typically corresponds with Saturn moving from  $180^0$  to  $216^0$  from the origin, at times making a double bottom at  $210^0$ , such as 1932 and 1933.

Chart 11.6 shows a 17-year cycle, 1949-1966, where  $\Delta$  Saturn= $180^0$  and  $\Delta$  Uranus= $72^0$  arrived simultaneously in 1966. This cycle did not have a major 3-year decline at the end. Prices continued up during the entire 17-year cycle into the 1966

Saturn-Uranus opposition, at which point the new 17-year cycle began. Cogan considered this an "inversion point" with his model shifting from negative to positive phase. Saturn continued to move from  $180^0$  in 1966 to  $216^0$  in 1968 making another major top. The  $\Delta$  Saturn= $180^0$  to  $216^0$  was not top-to-bottom, but was top-to-top.

This is a very interesting observation to be used in forecasting future 3-year declines that may or may not manifest. Simply running  $\Delta$  Saturn= $180^0$  from the start of a 17-year cycle will not always forecast a 3-year decline. It depends on the location of the Uranus cycle on that date.

Two of Cogan's most important components, A2+B3, can be pinpointed using this one cycle alone. The top occurs at  $\Delta$  Saturn= $180^0$  and continues thru  $\Delta$  Saturn= $216^0$ , conforming to the location of Uranus.

### **TIMING THE FIRST FIVE YEARS WITH $\Delta$ SATURN= $60^0$ AND GANN**

Saturn is the simplest cycle to use for this type of modeling because it moves about  $1^0$  per month. Instead of using one year, the Saturn model uses  $12^0$  Saturn. *Four-Dimensional Stock Market Structures And Cycles* showed the 5-year cycle was closely correlated with  $\Delta$  Saturn= $60^0$ .

Other Saturn harmonics are:

$\Delta$  Saturn= $120^0$  = 120 months = 10 years  
 $\Delta$  Saturn= $60^0$  = 60 months = 5 years  
 $\Delta$  Saturn= $36^0$  = 36 months = 3 years  
 $\Delta$  Saturn= $24^0$  = 24 months = 2 years  
 $\Delta$  Saturn= $12^0$  = 12 months = 1 year

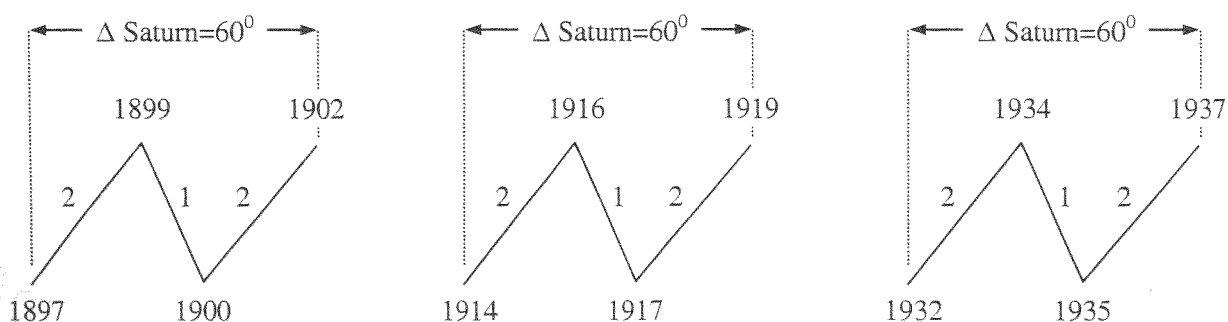


Cogan's 17-year model begins with a 1-1-2 yearly pattern starting in 1915. Gann wrote that the 5-year cycle is typically a 2-1-2 pattern. This book has shown that although the 2-1-2 pattern does not always match the data, it still works quite often, especially when matched with  $\Delta \text{Saturn}=60^0$ .

There are many planetary correlations with this 6-year bottom-to-bottom cycle. Charts 11.2 and 11.3 show  $\Delta \text{Saturn}=72^0$  and  $\Delta \text{Saturn-Uranus}=45^0$  match very well. The drop from year 5 to 6 corresponds with  $\Delta \text{Saturn}$  moving from  $60^0$  to  $72^0$ . This is A4+B5 in Cogan's composite (Figure 11.5.V).

Figure 11.6 shows the first five years of the 17-year cycles using Gann's 2-1-2 pattern. The alignment of these 5-year cycles with the  $\Delta \text{Saturn}=60^0$  cycle can be seen in Charts 11.2, 11.4, and 11.5.

Following the first 5-year cycle the market drops for one year to complete six years from the start of the 17-year cycle. This maintains the 6 years bottom-to-bottom of Cogan's model by changing the drop from 2 years to 1.



**Figure 11.6**

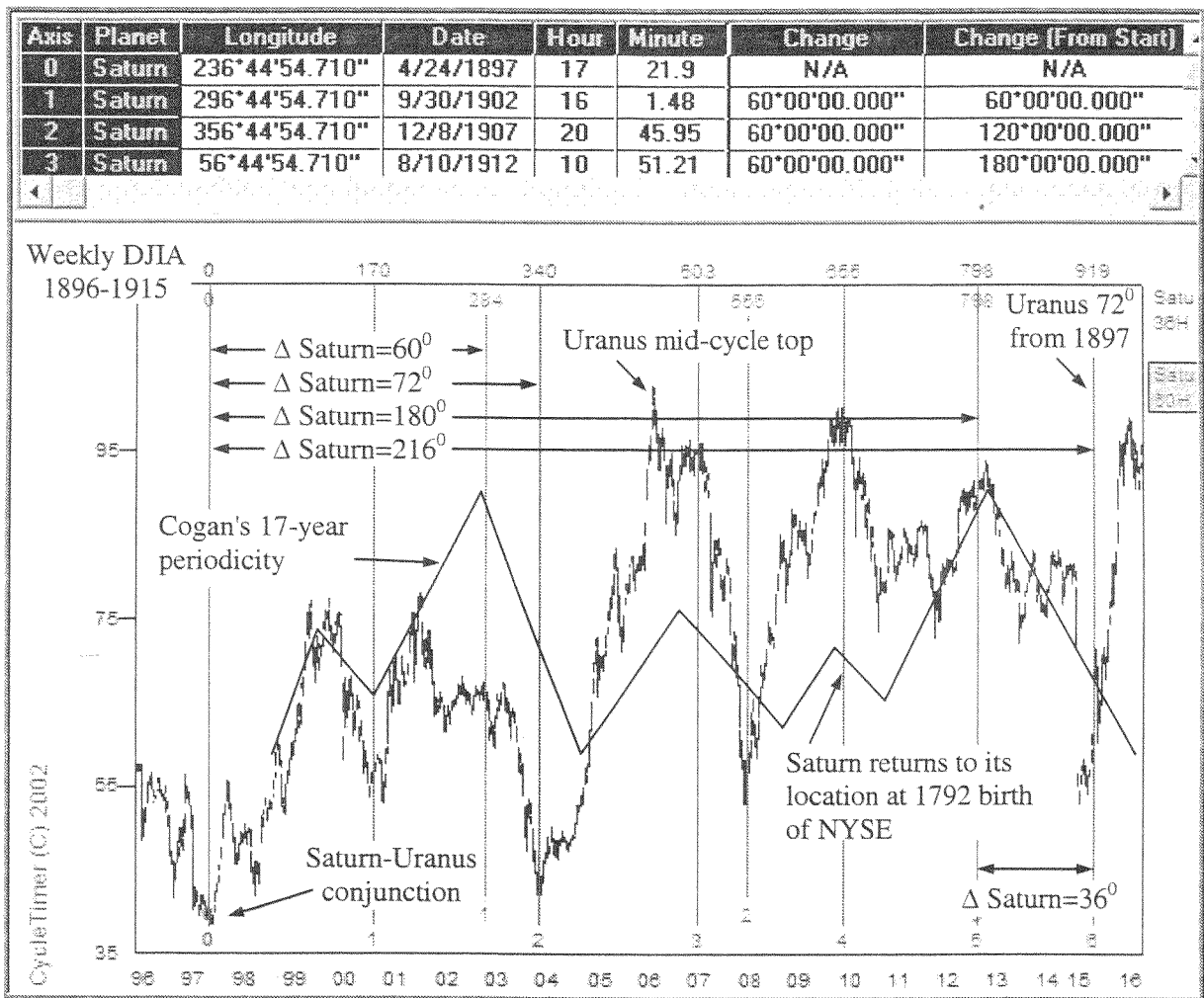
First 5-year cycle is  $\Delta \text{Saturn}=60^0$ . See Figure 11.5.U (A1+B4) and Figure 11.5.V (A4+B5)

**INCORPORATING  $\Delta$  SATURN= $36^{\circ}$  AND  $60^{\circ}$  INTO COGAN'S MODEL**

Chart 11.2 shows two Saturn cycles,  $36^{\circ}$  and  $60^{\circ}$  originating at the 1897 Saturn-Uranus conjunction. The  $36^{\circ}$  cycle shows where Saturn crosses the inner and outer Great Pentagram points. Every  $72^{\circ}$  from the conjunction at  $237^{\circ}$  is an outer pentagram point. Rotated  $36^{\circ}$  is the inner pentagram.

The times when Cogan's 17-year model does not match the actual market are when it deviates from the Saturn cycles, such as the bottom in 1908.

Saturn's location at  $60^{\circ}$  is shown in the spreadsheet above the chart.  $180^{\circ}$  is the only point where the  $36^{\circ}$  and  $60^{\circ}$  cycles align, timing the start of the 3-year decline to the end of the 17-year cycle.



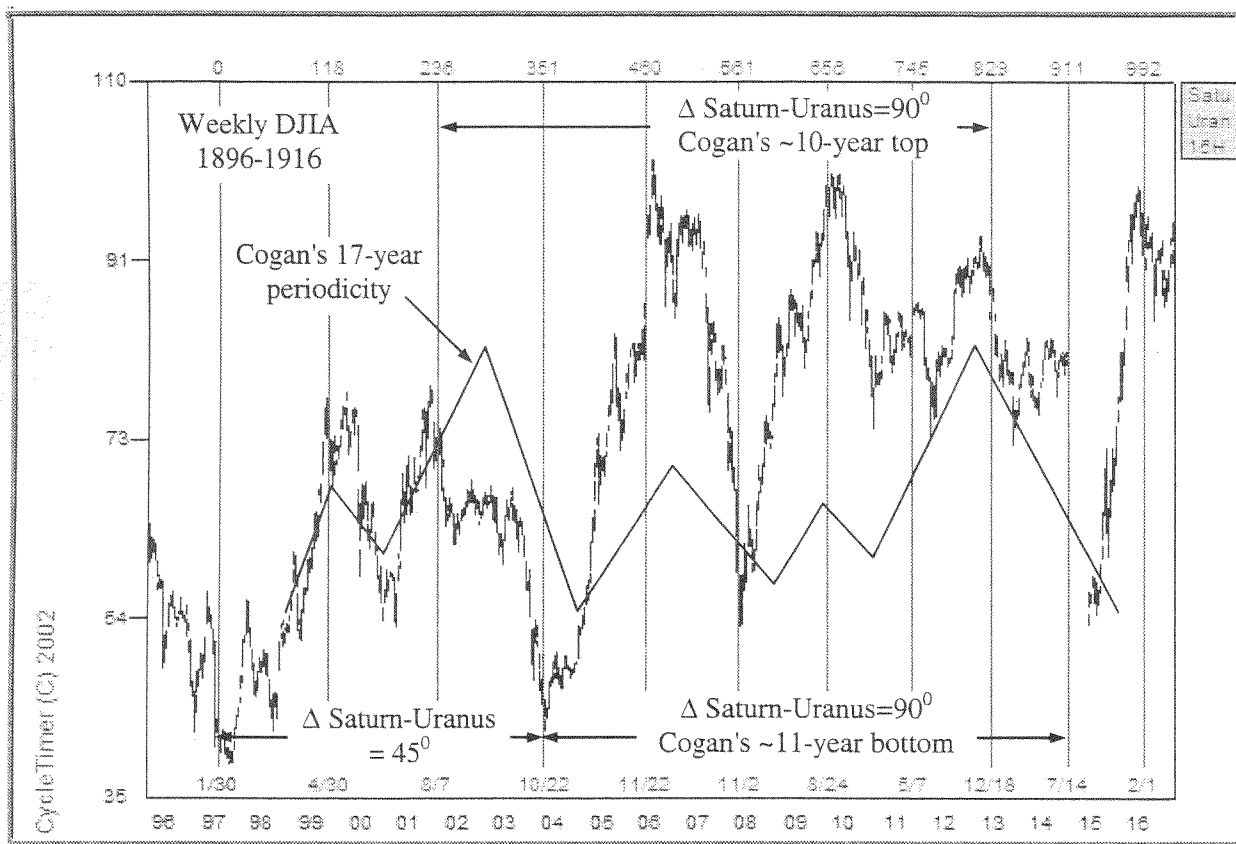
**Chart 11.2**

$\Delta$  Saturn= $36^{\circ}$  and  $\Delta$  Saturn= $60^{\circ}$  from the 4/24/1897 conjunction.

Chart 11.3 shows the same 1897-1914 time period as Chart 11.2. Drawn on this chart is the synodic cycle  $\Delta$  Saturn-Uranus= $15^{\circ}$ . A comparison of these two charts shows that the Saturn-Uranus cycles corresponded with the  $\Delta$  Saturn= $36^{\circ}$  cycles because Saturn and Uranus were moving in harmony along points of the pentagram. That is why there were such sharp clearly defined turning points closely aligned with sidereal Saturn and synodic Saturn-Uranus cycles.

The complete 17-year interval corresponded with both Saturn and Uranus moving between points on the Great Pentagram. Uranus moved  $72^{\circ}$  to the top in June 1914, followed by the big World War I break until Saturn completed its  $216^{\circ}$  cycle in early 1915. A similar situation occurred in 1981-1982 when Uranus topped in June 1981 causing the market to plunge into the August 1982 bottom at Saturn  $216^{\circ}$ .

Every recurrence of  $\Delta$  Saturn= $15^{\circ}$  marked significant market turns during these 17 years, as did Saturn-Uranus= $36^{\circ}$ . Notice that as Saturn moved  $72^{\circ}$  Saturn-Uranus moved  $45^{\circ}$ , such as 1897-1903, 1903-1909, and 1909-1914, all were major turning points.



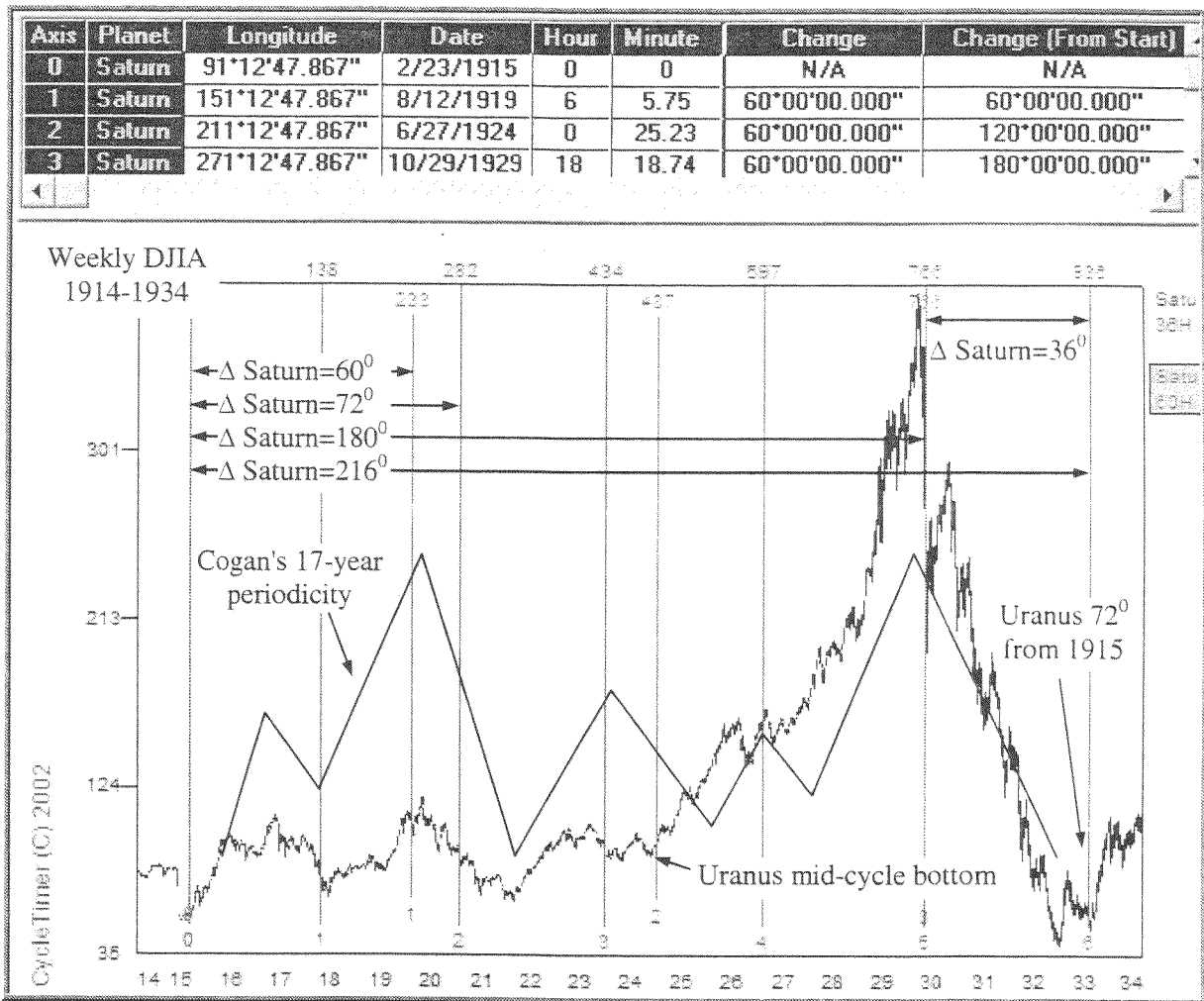
**Chart 11.3**  
 $\Delta$  Saturn-Uranus= $15^{\circ}$  and Cogan's 1897-1915 17-year periodicity.

**TIMING MID-CYCLE BOTTOMS WITH  $\Delta$  SATURN=120<sup>0</sup>**

Charts 11.2, 11.4, and 11.5 show that  $\Delta$  Saturn=120<sup>0</sup> from the start of 17-year cycles is about ten years and defined the bottoms in 1908, 1924, and 1942. This cycle often synchronizes with the Uranus cycle creating a strong turning point such as in 1924 and 1942. Cogan's model turned up in 1925 but the actual bottom was at the  $\Delta$  Saturn=120<sup>0</sup> and 180<sup>0</sup> Uranus mid-cycle bottom in 1924.

This is A3+B1 in Cogan's composite (Figure 11.5.W).

Cogan's model follows a 1-1-2 yearly pattern after 1925. It was actually a five-year cycle from 1924-1929, taking a 2-1-2 pattern. Moving the data point back from 1925 to 1924 puts it at the  $\Delta$  Saturn=120<sup>0</sup> and Uranus mid-cycle bottoms, which is nine years from the 1915 bottom and 8 years from the 1932 low. Again, Cogan's model bottomed a year late, same as the 1908 bottom.



**Chart 11.4**

$\Delta$  Saturn-Uranus=36<sup>0</sup> and  $\Delta$  Saturn-Uranus=60<sup>0</sup> with Cogan's model, 1915-1933.

©2009 COWAN

The 1932-1949 cycle provides the best match with Cogan's model. Because his book was written in 1969, it is quite possible this section of market greatly influenced his choice of cycles when making the composite. The model may have been made to match the market data during this cycle.

It is no coincidence that the model aligns very well with the Saturn cycle during this time. Unlike the mid-cycle bottoms in 1908 and 1924, the 1942 bottom aligned with the

model because both arrived right at the  $\Delta$  Saturn =  $120^\circ$  cycle measured from 1932.

The model deviated from the market in 1936 where the actual top occurred at the  $\Delta$  Saturn =  $60^\circ$  cycle in 1937.

The spreadsheet data above the chart shows that the  $\Delta$  Saturn =  $120^\circ$  cycle measured from the 1932 low arrived only one degree from the 1942 Saturn-Uranus conjunction at  $59^\circ 45'$ .

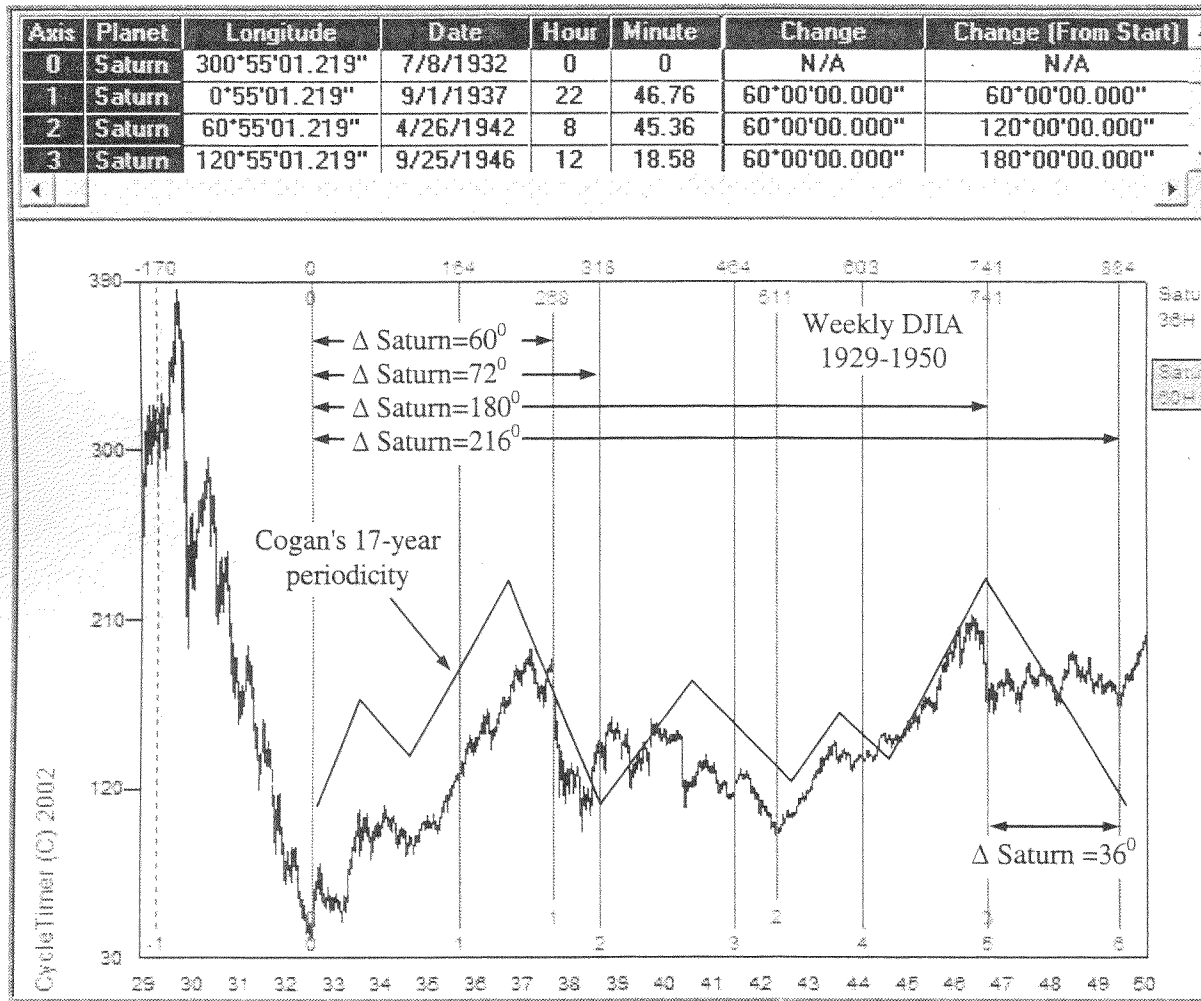


Chart 11.5

$\Delta$  Saturn-Uranus =  $36^\circ$  and  $\Delta$  Saturn-Uranus =  $60^\circ$  with Cogan's model, 1929-1949.

©2009 COWAN

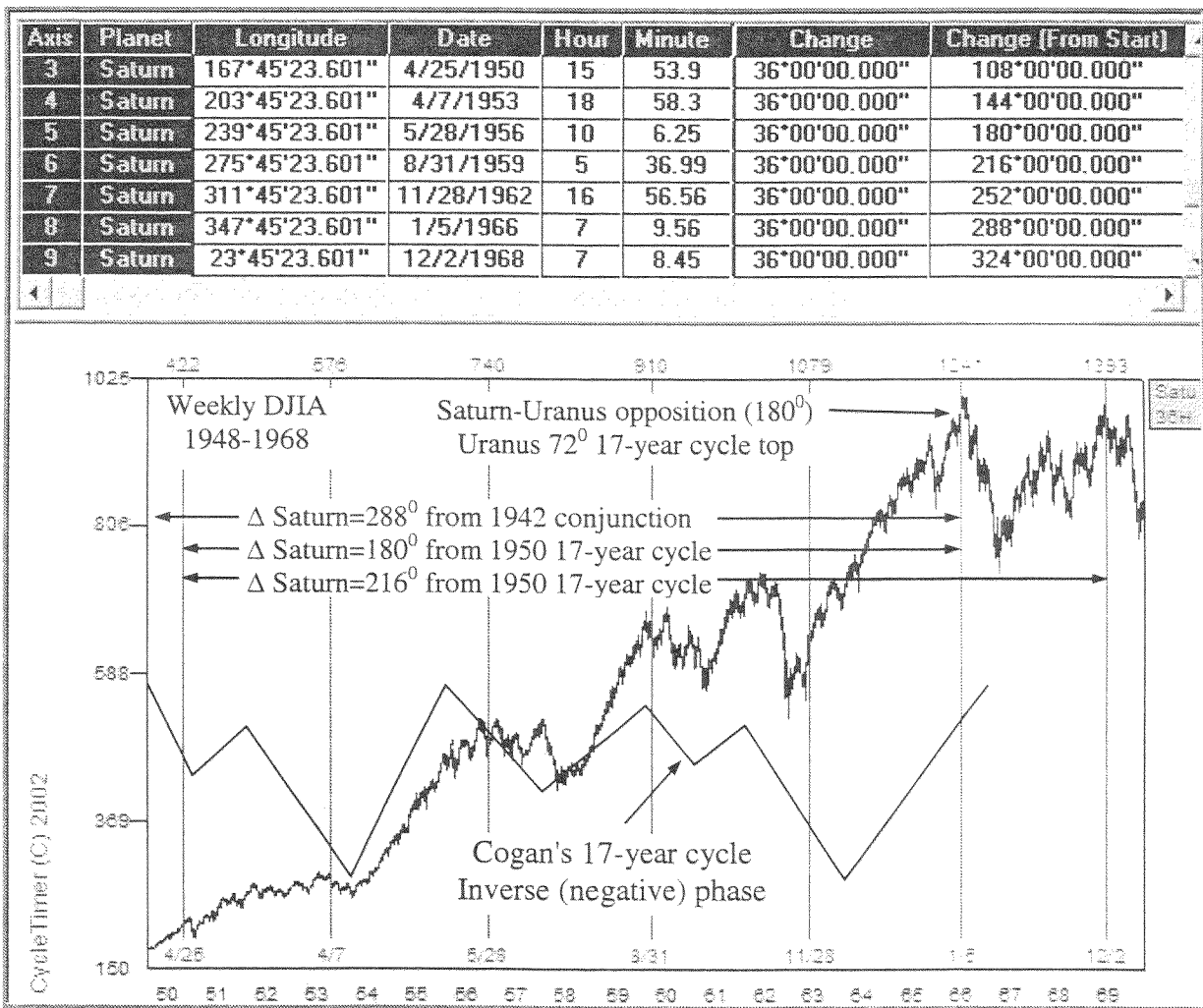
**EXAMPLE OF THE 17-YEAR MODEL  
IN THE NEGATIVE PHASE**

The 1949-1966 bull market is the only complete example of Cogan's inverted cycle before the 1969 publication.

The location and orientation of the 17-year model is as he showed it in Chart I in his book. It is exactly like the model shown in the 1897-1949 sections except it is flipped

upside down 180°. Again, this market data was available before his model was published.

The origin of the  $\Delta$  Saturn=36° cycles shown on the chart is the 1942 Saturn-Uranus conjunction. Notice in the spreadsheet data that these points are on the Great Pentagram because the 1942 conjunction was 183° from the 1897 Great Conjunction.



**Chart 11.6**  
Cogan's 17-year periodicity in the negative phase, 1949-1966.

The starting date and phase of Cogan's 17-year model after the 1966 top is shown in his book. Only 3 years of that cycle unfolded before the book was published in 1969.

Chart 11.7 shows his model still matched the data relatively well, although not as good as the 1932-1949 section. The model typically underestimates the magnitude of mid-cycle panics such as 1973-1975. These panics are often the largest in the 17 years. The

relatively small mid-cycle decline during the 1932-1949 section possibly caused him to underestimate this cycle.

Again, this 17-year cycle can be seen terminating in August 1982 at  $\Delta$  Saturn=216°.

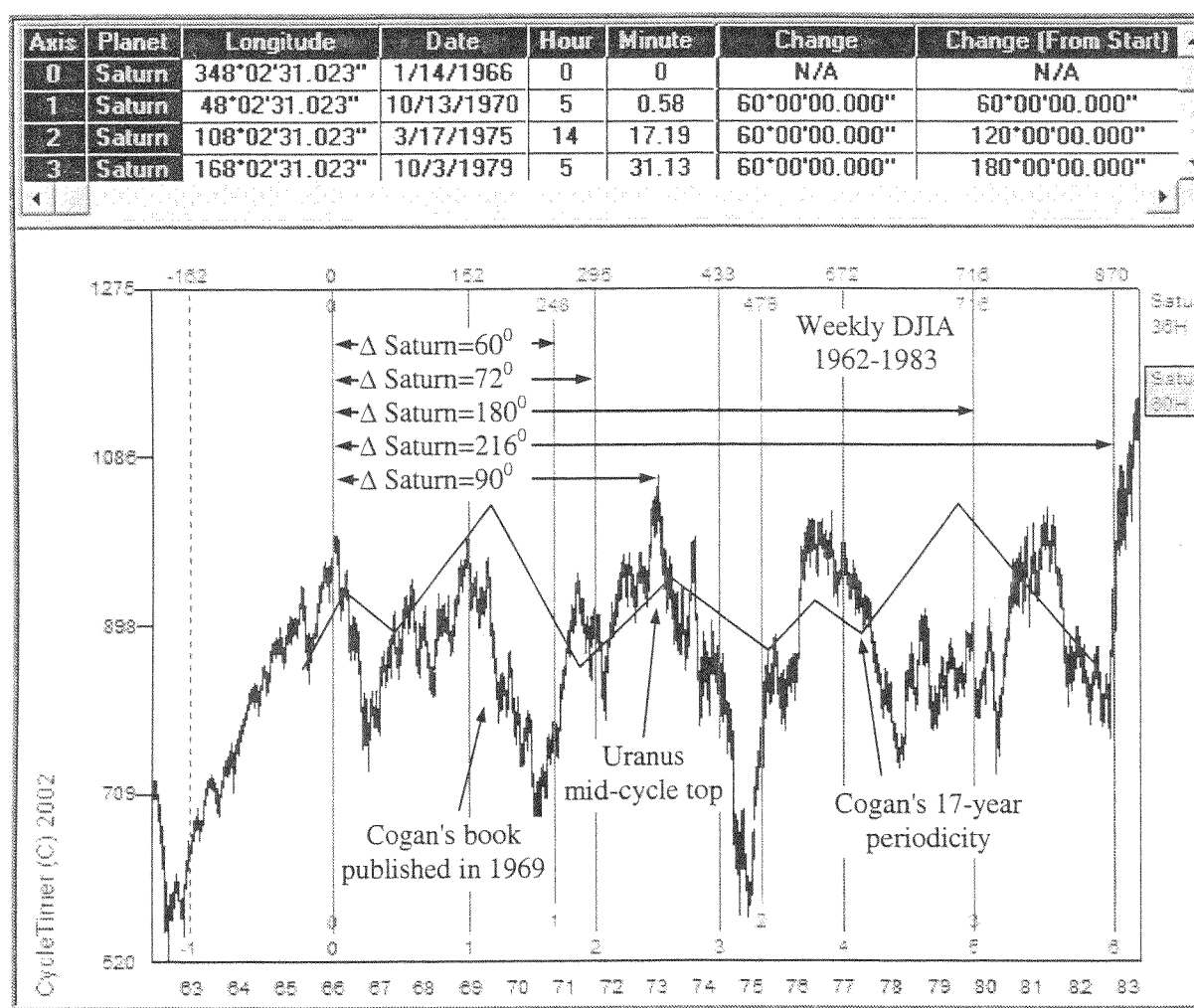


Chart 11.7

$\Delta$  Saturn-Uranus=36° and  $\Delta$  Saturn-Uranus=60° with Cogan's model, 1966-1982.

Chart 11.8 begins the  $\Delta$  Saturn= $36^\circ$  and  $60^\circ$  cycles at the conjunction on June 9, 1988. This conjunction occurred at  $269^\circ$ , rotated  $360^\circ + 32^\circ$  from the 1897 Great Conjunction. The spreadsheet shows the conjunction and subsequent  $36^\circ$  cycles were very near the Great Pentagram points, differing by about  $3^\circ-4^\circ$ . Alignment of the  $36^\circ$  cycles with the Great Pentagram produces even better results.

The SP500 was chosen for Chart 11.8 because of the pronounced double top in 2000-2007. The 2000 top was  $\Delta$  Saturn= $144^\circ$  from the conjunction leading to the 3-year bear market that ended at  $\Delta$  Saturn= $180^\circ$ .

The 2007 Uranus mid-cycle top was  $\Delta$  Uranus= $180^\circ$  from the 1966 top and  $360^\circ$  from the 1924 bottom.

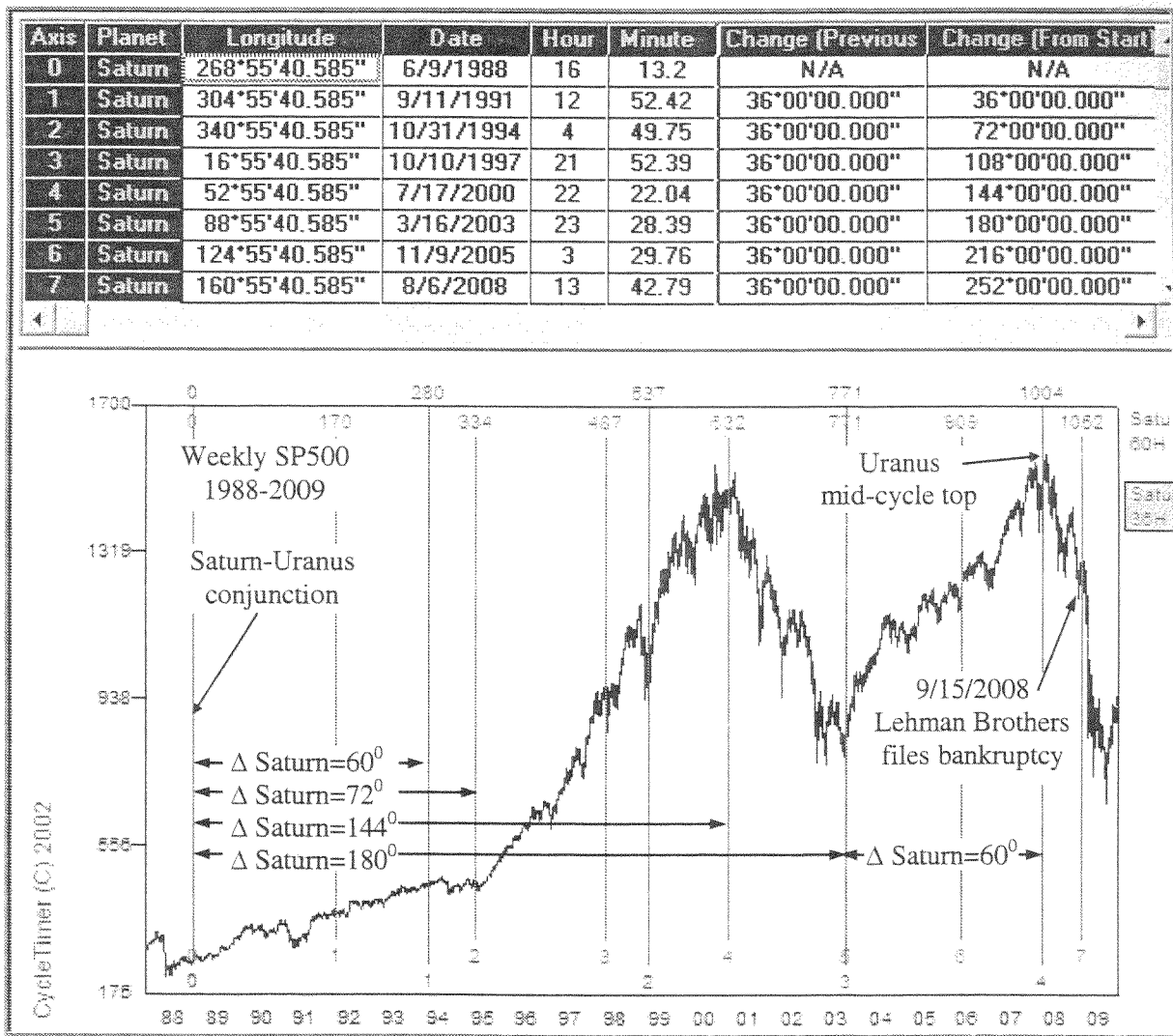


Chart 11.8

$\Delta$  Saturn= $36^\circ$  and  $60^\circ$  from the 1988 S-U conjunction. Return points on the Great Pentagram.



**ALIGNING COGAN'S MODEL WITH  
 $\Delta$  SATURN=36° and  $\Delta$  SATURN=60°**

Chart 11.9 shows the three 17-year cycles used in Cogan's book that were in the positive phase. Two Saturn cycles are overlaid on the charts,  $\Delta$  Saturn=36° and  $\Delta$  Saturn=60°. The tops and bottoms of the Cogan model are moved to align with these two cycles. Even though this is a very simplified model using only two Saturn cycles it matches the data much better than the original Cogan model. In the real world the analyst would at least include knowledge of the Uranus cycle, such as mid-cycle turns at the top in 1906, and the motion of Saturn relative to Uranus.<sup>38</sup>

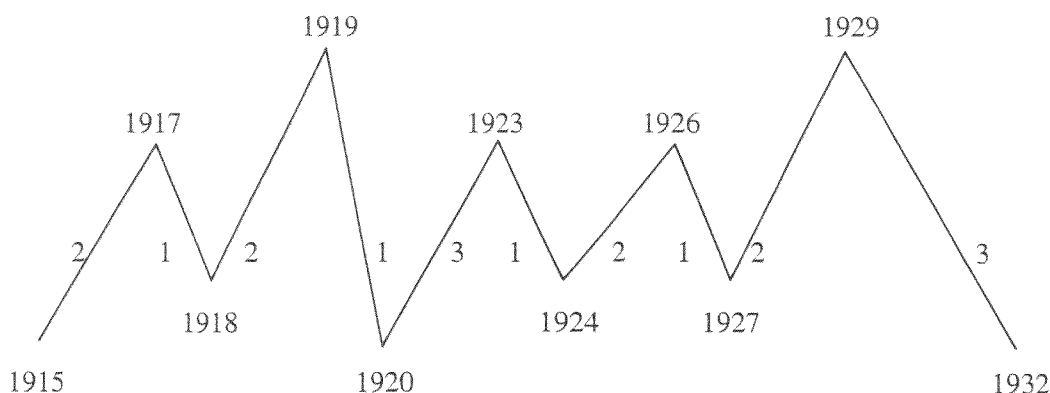
Using Gann's 2-1-2 pattern and moving the mid-cycle bottom back to align with Saturn, the modified model takes the form of overlapping 5-year cycles,  
 2 - 1 - 2 - 1 - 3 - 1 - 2 - 1 - 2 - 3.

The techniques described above and the cycles shown on Chart 11.9 show how the analyst can create a 5-wave composite without a computer. Each component is a pulse as described in Figure 11.5.

**LOCATION OF THE 17-YEAR CYCLE  
 AFTER 2000**

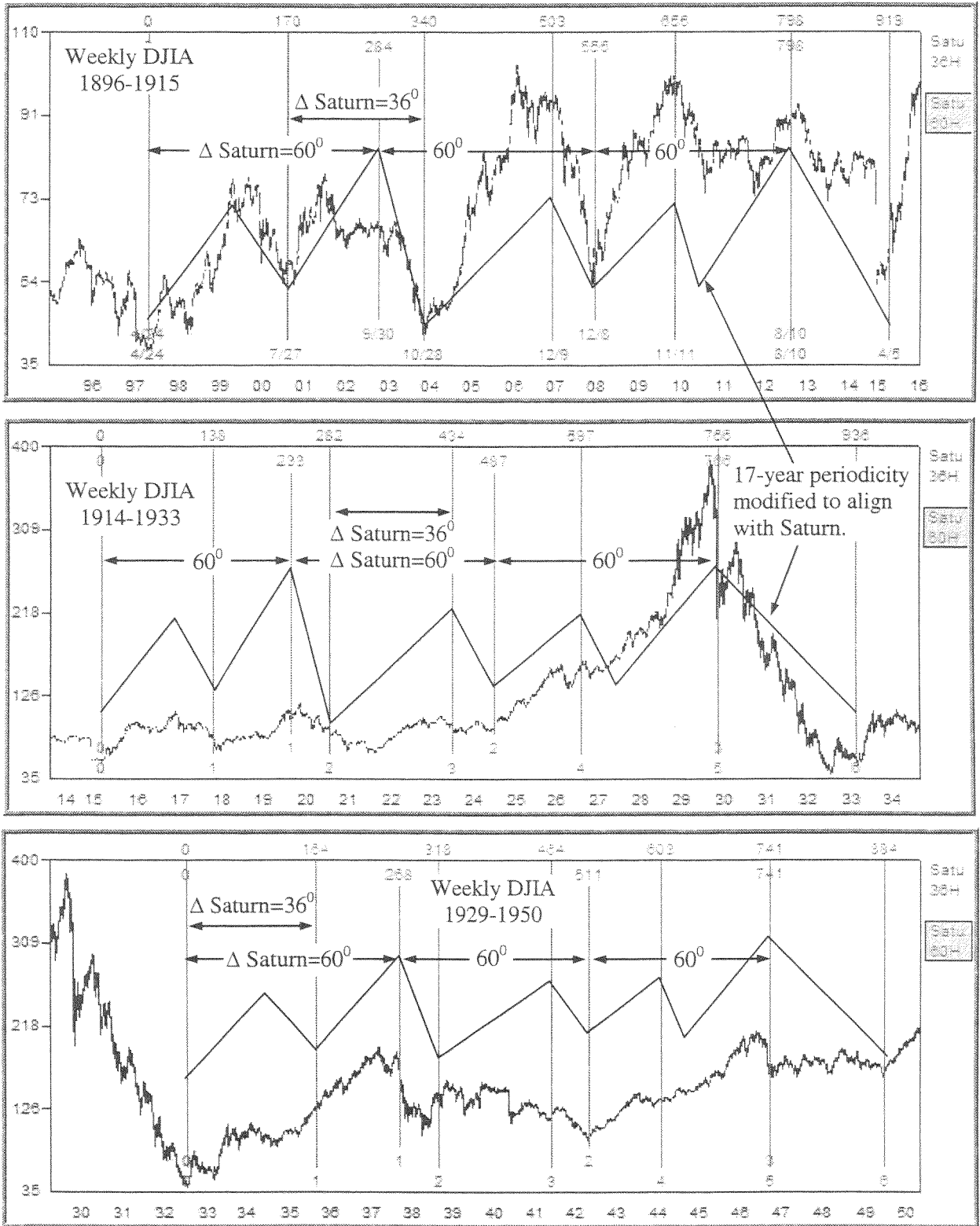
As of this writing in 2009, the cycle that began in 2000 is a little more than half finished. For academic purposes, Chart 11.10 shows three possible orientations for Cogan's model. Chart 11.10.A shows the simplest option with the cycle in the positive phase and aligned as in 1966-1982.

Chart 11.10.B shows the inverse or negative phase. It is the same as Chart 11.10.A except flipped upside down 180°. Chart 11.10.C uses knowledge that the 2000+ market matches the 1929+ pattern. The 17-year pattern after 1929 is overlaid on the 2000+ chart. The reader can decide for himself which of these orientations, if any, best fits the data.



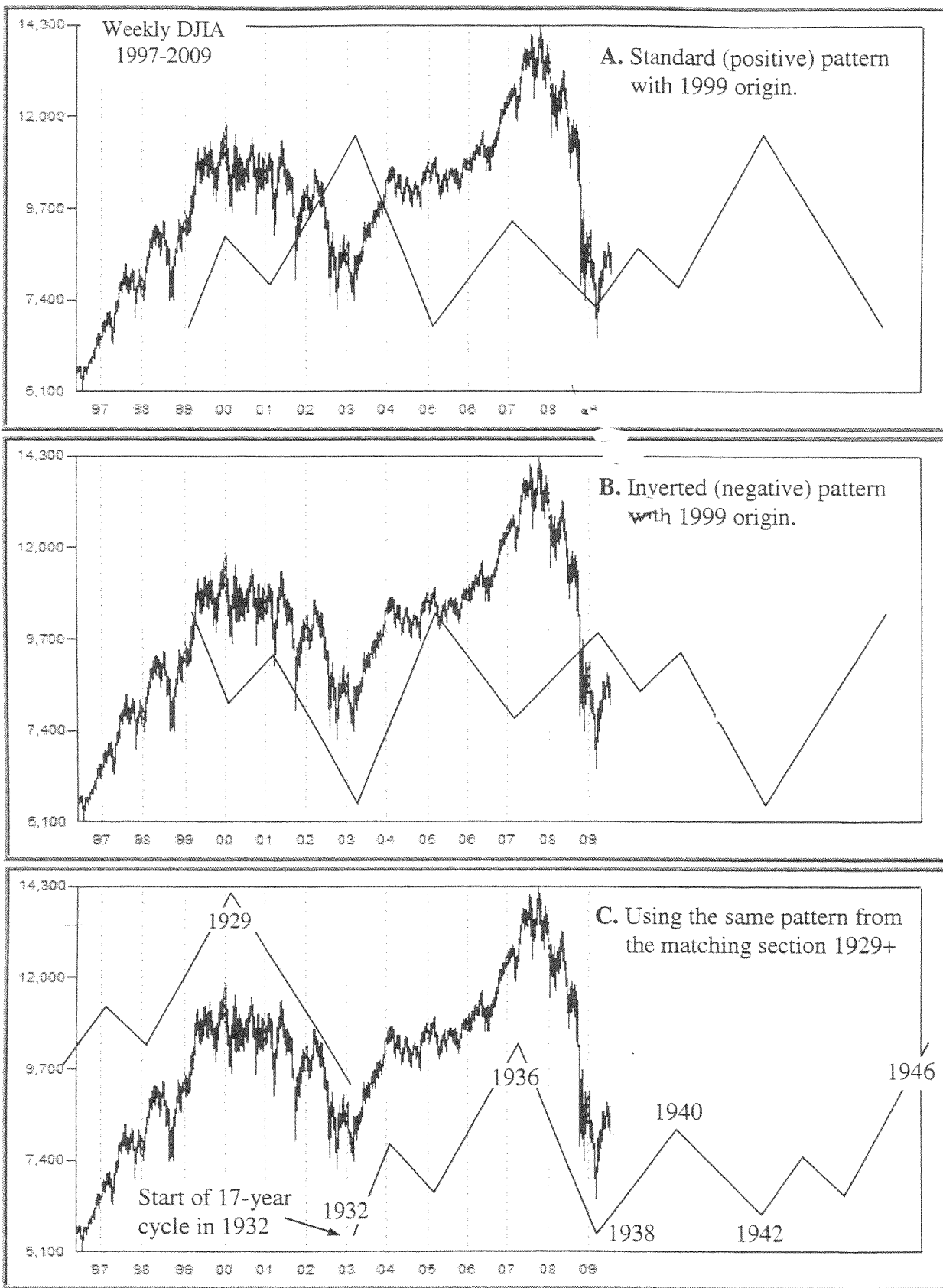
**Figure 11.7**  
 17-year periodicity aligned with the Saturn cycle, 1915-1932.

<sup>38</sup> Charts VIII.E and VIII.F in *Four-Dimensional Stock Market Structures And Cycles* illustrated the Saturn-Uranus cycles during this period.



**Chart 11.9**

17-year periodicity modified to align with  $\Delta \text{Saturn} = 36^\circ$  and  $60^\circ$  cycles, 1897-1949.



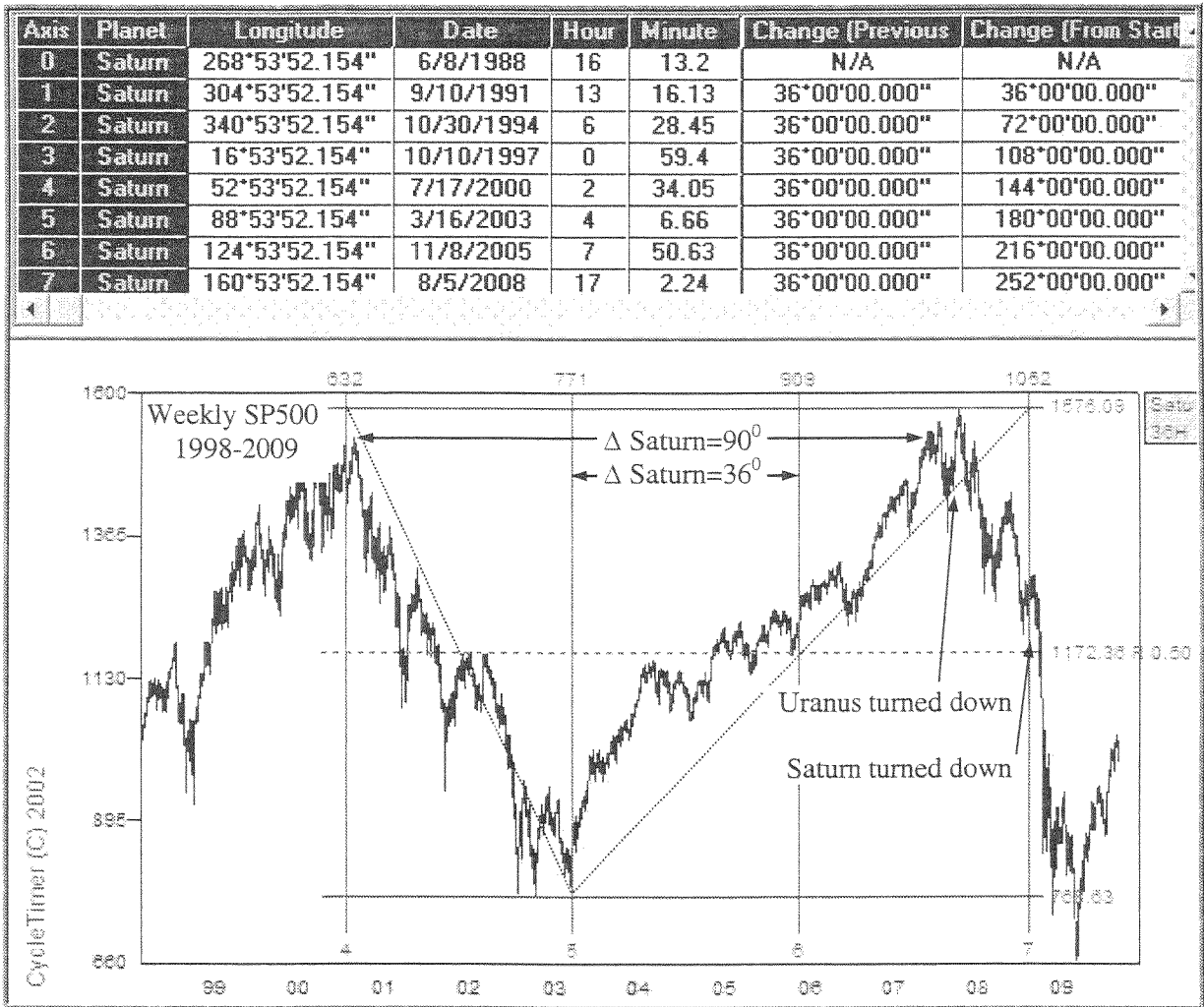
**Chart 11.10**  
 Three possible options for Cogan's 17-year pattern after 2000.

**PRICE AND PLANETARY  
DISPLACEMENT SQUARES**

Although this book is mostly about time cycles, it is a good point to show how planetary cycles define the Gann Squares in both price and time. Chart 11.11 plots the  $\Delta$  Saturn= $36^\circ$  cycles originating at the 6/8/1988 Saturn-Uranus conjunction. The 50% price retracement and diagonals of the squares are also shown.

The price action followed these diagonals with a linear trend. At the 2007 top the Uranus mid-cycle turned down, exactly  $\Delta$  Uranus= $180^\circ$  from the 1966 top. The Saturn cycle turned down later in August 2008, followed by the panic and price avalanche.

The vertical lines on these squares are not time but are  $36^\circ$  displacement of Saturn.



**Chart 11.11**  
 $\Delta$  Saturn= $36^\circ$  price-time squares.

## Conclusion

Since I was a very young man, one consistent theme underlying my motivation to explore technical analysis is the belief that financial markets are not random events, rather are reflections of the natural laws we see all around us. To understand these natural laws and apply them to market trends presented quite a challenge because there was scarce material of any value on the subject. There were many good science books and seemingly endless books and courses on "spiritualism" and other intangible philosophies. But almost nothing that could connect the two by showing examples in real stock market charts.

Spiritualism is one of the easiest things to teach because it requires no proof. It does not have to adhere to the scientific method of data observation, collection, hypothesis, and proof. None of those "spiritualist" based books, courses, or seminars proved any of their hypotheses by showing examples in stock market charts, most likely because they could not. As an engineer, this was unacceptable to me and further stoked my desires to make the connection to provable market data that was otherwise lacking.

Those who think this book is about market timing are only partly correct. There is a much larger underlying theme of trying to understand the greater forces influencing the lives of men. Man does not have the capacity to fully understand the things that are so great they are beyond us. However, by building understandable models and establishing correlations with observed natural phenomena we edge just a little closer to achieving the impossible, understanding the infinite.

My first experience with a high-powered telescope was as a college student studying basic astrophysics. All these years later, I still remember standing on the roof of the university physics building looking at the planets, their moons, and the vast emptiness beyond them. That dark emptiness, void of life or matter, made me very aware of how special Earth is and the life it holds.

The growth and structure of flowers, motions of the planets, the human body, and the stock market all follow the same common pattern of pentagonal symmetry. The much maligned pentagram has been vilified by Hollywood movies for years giving it a mysterious and occult reputation.

This has not always been the case. At least as early as 3,000 B.C. the pentagram was recorded in writings of the Babylonians. In 600 B.C. the great mathematician and philosopher Pythagoras gave it great importance as the symbol of his order, or group of comrades. The Pythagorean orientation of the pentagram was the same as in this book, pointing downward with two points up. The reader is encouraged to research on his own the rich history of the pentagram.

This book has shown there is a Great Pentagram identifying turning points in the stock market when planets align on its five points. The location of this Great Pentagram was fixed at the May 17, 1792 birth of the NYSE at the signing of the Buttonwood Agreement. On this date Saturn was at  $23^{\circ}$ , in opposition to the Mars-Jupiter conjunction, and Earth was at  $237^{\circ}$ , another point on the Great Pentagram.

As the slow moving Uranus moves around the zodiac it crosses one the five points on a Great Pentagram every 17 years. Saturn moves in harmony with Uranus resonating with the five points on the Great Pentagram every  $216^{\circ}$ . When these two planets arrive at a 17-year cycle close together they create quick rallies or double bottoms such as 1932-1933. When the planets arrive at the 17-year cycle further apart double tops or bottoms a couple years apart form such as 1966-1968.

Uranus is the larger wheel on the clock of economic and market cycles. Ezekiel's concept of wheels-within-wheels leads us to start each Saturn cycle at a Uranus pentagram point. From these origins Saturn resonates with every point on the inner and outer pentagrams, or every  $36^{\circ}$ . The 17-year cycle in bull phase typically ends with a difficult 3-year bear market timed when Saturn has moved  $180^{\circ}$  from the 17-year cycle origin. The ensuing decline ends when Uranus  $72^{\circ}$  and Saturn  $216^{\circ}$  bottom at the end of the 17-year cycle.

Uranus also identifies the major declines that occur at the mid-point of 17-year cycles by measuring  $180^{\circ}$  from the start of a preceding cycle, often accurate to the day, such as in October 2007. These  $180^{\circ}$  points of Saturn and Uranus locate the inner and outer pentagrams.

L. Peter Cogan studied the 17-year cycle years ago when he tried to explain the periodicity with a composite of ten simple cycles. Considering the simplicity of his model it matched the data relatively well. The results are greatly improved when the timing of the tops and bottoms are aligned with Saturn and Uranus. The large 3-year decline at the end correlates with Saturn moving  $180^{\circ}$  from the origin. The bottom at the middle aligns with Saturn moving  $120^{\circ}$

from the origin. The very reliable  $180^{\circ}$  Uranus mid-cycle can also pinpoint one of the simple components associated with a major panic.

The fractal nature of planetary cycles showed the inner planets form the same Golden Triangle combination on the Great Pentagram as Saturn, Uranus, and Jupiter. When Earth, Venus, and Mars align on points of the Great Pentagram the markets reach extremes of emotion and reverse direction. This combination of planets manifests in markets every 12.8 years with dramatic market panics. Sometimes it marks the termination of a panic such as 12/1974. The magnitude of the reversal is greatly magnified if one of the larger planets aligns on the Great Pentagram along with the inner planets. 1962 was a good example of this with Jupiter and Saturn conjoined on the Great Pentagram and the inner planets in Golden Triangle formation, a very deadly combination, as evidenced by the ensuing panic.

The proof of these cycles was shown by providing a public real-time trading example at the March 2009 bottom. Several of the cycles taught in this book were used to make that market call and trade, showing this material has great practical value.

Financial markets provide just one of the laboratories to study the forces influencing the ever changing tides of human optimism and pessimism. Wars also loom as milestones in time at an extreme of mass emotion, marking the paths to be taken in business, government, and philosophy. W.D. Gann wrote that market analysts must study war periods, and he was right. Historical charts show that there is almost always a business boom during war times as demand and consumption of manufactured goods and commodities increases dramatically.

The political danger of the stimulus wars provide to business is that power-hungry politicians often can not resist the temptation to maintain their grip on power by bringing their economies out of depression with a "just cause" war.

It is now November 2009, more than one year since I pulled the basics of this material out of my files and began rewriting and updating it. Rarely a day went by that I did not spend several hours working on it. The introduction was rewritten in January when the stock market was in panic. My initial goal was to explain why the panic was occurring and to let the public know they did not need to worry about it and that the panic was a natural event that would soon end, as it did in March.

I hope the effort has provided the reader with additional knowledge and tools to improve his investing decisions. As with my previous writings, I hope it leads other researchers to expand on it, improve it, and to pass the torch on to the next level.

*I don't want to live on in my work.*

*I want to live on in my apartment.*

... Woody Allen

# **The Rhythmic Cycles of Optimism and Pessimism**

Their origins; their effects upon stock market prices,  
money and credit, other leading indicators, and private spending;  
their challenge to the random-walk theory

(Retyped Version)

by L. Peter Cogan



<b>Introduction</b> .....	1
1. The ideal rhythmic cycles of optimism and pessimism, 1870-1969.....	3
2. A comparison of actual stock prices, 1871-1968, with the ideal ..... rhythmic timing patterns of optimism and pessimism	8
3. A comparison of the actual prices of a cyclical stock, TWA, with the ideal ..... time-amplitude pattern of optimism and pessimism	12
4. The random-walk theory of stock market prices and the rhythmic ..... cycles of optimism and pessimism	16
5. The money supply, the major business contractions, and the ideal rhythmic ..... cycles of optimism and pessimism	17
6. Some leading business indicators and the ideal rhythmic pattern .....	20
7. The possible origins of the rhythmic cyclical patterns .....	24
8. Conclusions and implications .....	28
 <b>Appendix</b>	
A. Favorable and unfavorable factors in the business outlook and ..... their influence upon business confidence	30
B. Seasonable peaks of common cold incidence and sunspot activity.....	34

## *Charts*

Chart I.	The rhythmic cycles of optimism and pessimism, 1870-1968, .....4 and stock market prices, 1871-1968
Chart IIA.	Actual versus ideal tops and bottoms in stock market prices- positive phase.....9
Chart IIB.	Actual versus ideal tops and bottoms in stock market prices - negative phase .....9
Chart III.	Trans-world airlines, 1932-68, versus the ideal pattern.....13
Chart IV.	Ideal cycles versus money and credit.....18
Chart V.	Ideal cycles versus the leading indicators.....21
Chart VI.	Overlapping rhythmic cycles and timing of reversals .....25

## *Figures*

Figure 1.	The ideal timing pattern in the positive phase, 1915-32.....5
Figure 2.	The ideal timing pattern in the negative phase, 1951-66.....5
Figure 3.	Dow-Jones industrial average and rail average .....14

*Acknowledgments*

The chart and figure materials in this monograph are by the author, with the exception of Figure 3 ( the Dow-Jones Industrial and Rail Averages), which is reprinted from *The Stock Picture*, published by M.C. Horsey & Co., Salisbury, Maryland 21801, with the permission of the publisher.

The two papers included in the Appendix as collateral material to the thesis of this work were written by the author in 1937 and 1959, respectively.

**WWW.FOREX-WAREZ.COM**  
**ANDREYBBRY@GMAIL.COM SKYPE: ANDREYBBRY**

*About The Author*

An economist, scientist, and merchandiser, L. Peter Cogan was born in Vermont and was graduated a Phi Beta Kappa from Tufts College in 1936. He received his M.B.A. degree with distinction in 1938 from the Harvard Business School, where he was a research assistant at the Bureau of Business Research. Joining the Abraham and Straus department store organization, he held various merchandising positions and served as a vice president until his retirement in 1967, when it was stated: "His unusually perceptive approach to merchandising techniques and his remarkable ability to analyze and interpret figures has given his work a very special distinction." Mr. Cogan's listings in Who's Who in the East, World Who's Who in Commerce and Industry, and Leaders in American Science note several research papers he has authored and his membership in numerous economic and scientific professional societies.

Mr. Cogan resides in New York City.

Although it is generally accepted that stock market prices reflect recurring alternations of optimism and pessimism to a considerable degree, most authorities are of the opinion that no clear evidence has been presented to indicate that stock market prices and/or optimism and pessimism tend to repeat themselves in cycles of approximately the same form and/or duration. Many attempts have been made to show a periodicity of business cycles, that is, a definite time interval from peaks to troughs, peaks to peaks, and troughs to troughs. None of these has stood up over a long period of time. The various lengths that have been presented have had the character of averages rather than of mechanical periodicity. On the other hand, current economic theory does not adequately explain the major and unexpected turning points in business and consumer sentiment.<sup>39</sup>

After thirty years of empirical observation and correlation—inspired by the late Joseph Snider, my professor in the course on business conditions analysis at the Harvard Graduate School of Business Administration; by the pioneering studies of Arthur F. Burns, Wesley C. Mitchell, and Geoffrey H. Moore at the National Bureau of Economic Research; by Elmer C. Bratt's *Business Cycles and Forecasting* (1937); by Harold T. Davis' *The Analysis of Economic Time Series* (1941) for the Cowles Commission for Research in Economics; and by Edward R. Dewey's extensive comparative cycle research for the

Foundation for the Study of Cycles—I have discovered rhythmic (that is, reasonably regular) cyclical patterns of optimism and pessimism on a yearly basis from 1870 to 1968.

### *A Challenge to the Random-Walk Theory*

The aim of this monograph is to present these rhythmic cycles and to show that private borrowing, major business contractions, various leading indicators, and especially stock market prices (a very sensitive and volatile leading indicator of business activity) appear to follow these rhythmic cycles of optimism and pessimism to a remarkable degree in timing, sequence, and amplitude tendency. This phenomenon indicates that changes in direction and degree from optimism to pessimism, and vice versa, are not wholly chance or random behavior. It challenges the random-walk theory of stock market prices and implies that to a considerable extent stock market cycles and the persistent fluctuations of the United States economy have a psychological origin that is rhythmic.

### *An Important Aid to Fiscal and Monetary Decision-Makers*

Knowledge of the rhythmic pattern of turning points in optimism and pessimism, especially after it has been refined to a monthly or even to a quarterly basis, could be an important aid to the proper application of fiscal action and monetary management. Economic policy decisions require the forecast of a number of economic variables, but the most difficult and important variables to forecast are expenditures in the

---

<sup>39</sup> My paper, "Favorable and Unfavorable Factors in the Business Outlook and Their Influence on Business Confidence", November 26, 1937, at the Harvard Business School (see Appendix A), impelled me to search for new explanations for the changes in confidence.

private sector of the economy, i.e., business investment in plant, equipment, and inventories, and consumer spending for durable goods. In both of these categories the direction of future expenditures is based upon both the ability to spend and the willingness to borrow, lend, and spend. The current and future willingness to borrow, lend and spend is in a large measure dependent upon the psychological factor of optimism or confidence. Consequently, a

rhythmic cyclical pattern of optimism and pessimism that is non-random throws new and revealing light on turning-point theory, on forecasting problems, and on monetary and fiscal policies for economic growth and stability. Further economic-scientific research needs to be directed toward their causation in order to refine the rhythmic cycles to a quarterly or monthly basis and to validate projections of the rhythmic patterns into the future.

## 1

## The Ideal Rhythmic Cycles of Optimism and Pessimism, 1870-1969

### Chart IA Shows the Ideal Timing

Chart I,A presents the ideal timing of the cycles of optimism and pessimism from 1870 to 1968. The solid lines indicate the years when the cycles are in the “positive” phase; the dotted lines indicate the years when the cycles are in the “reverse” or “negative” phase.

#### The “Positive” Phase

An analysis of Chart I,A indicates that an “ideal” 17-year timing pattern for the positive phase (from late 1888 to the middle of 1950) appears to be as shown in Figure 1, when the long-term trend has been removed. For example, the 1912-32 pattern is indicated in Figure 1 (The Ideal Timing Pattern in the Positive Phase).

The ups and downs follow this pattern for 17 years and then repeat themselves (up approximately 1 year, down 1 year, up 2 years, down 2 years, up 2 years, down 2 years, up 1 year, down 1 year, up 2 years, and down 3 years). Each peak and each trough has a corresponding peak and trough approximately 17 years apart. Consequently, the 3-year decline from 1929 to 1932 repeats itself 17 years later, from 1946 to 1949, and 17 years earlier, from 1912 to 1915. Within an ideal 17-year period, as indicated in Figure 1 and Chart I,A, the troughs tend to appear at intervals of approximately 2, 4, 4, 2, and 5 years apart; the peaks are 3, 4, 3, 3, and 4 years apart. Note the 5-year interval between the troughs of 1910-15, 1927-32, and 1944-49, each 17 years apart.

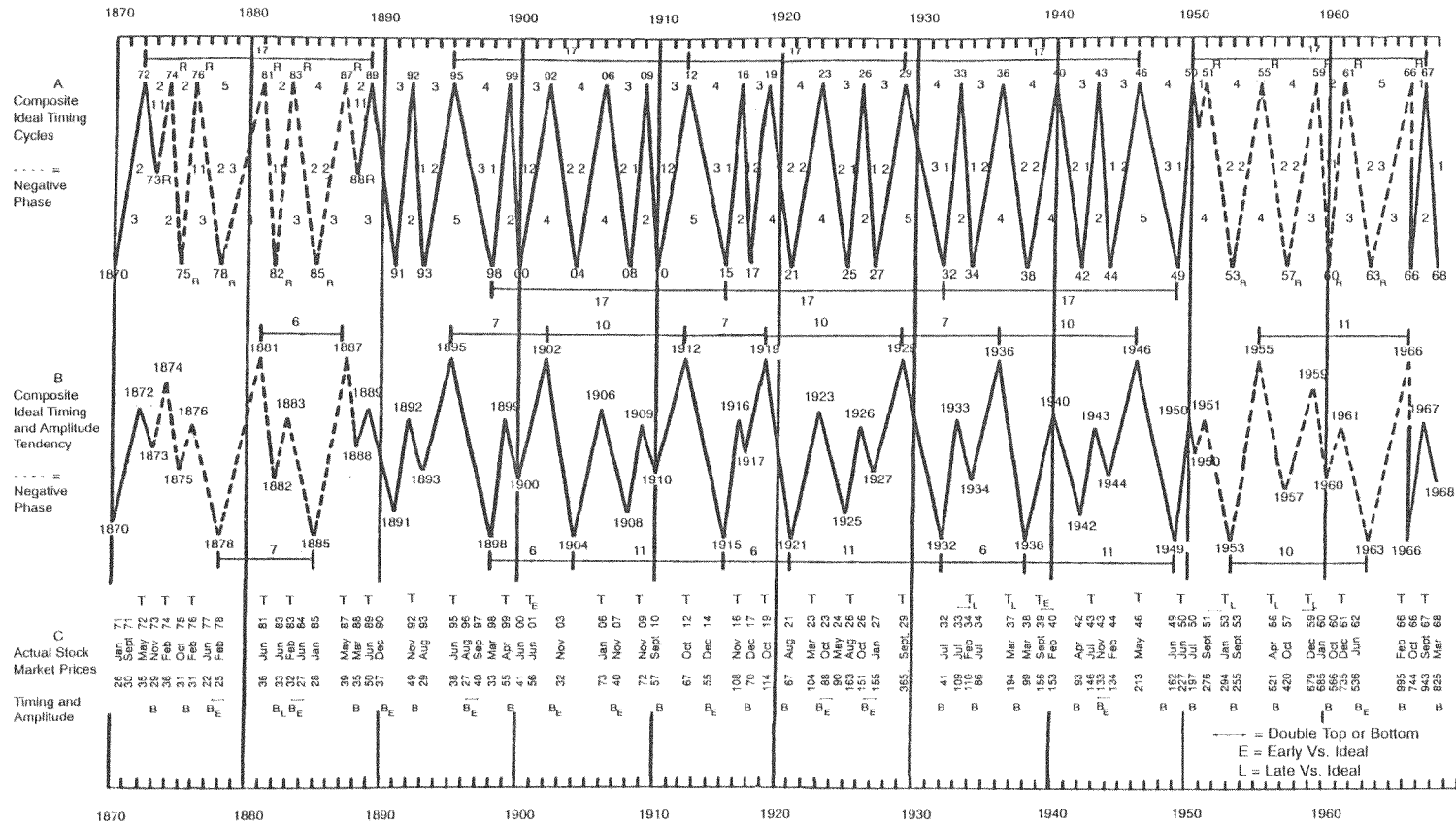
### The “Negative” or Reverse Phases

The ideal timing pattern for late 1873 to early 1888 and for late 1950 to early 1966 (Chart I,A, dotted lines) appears in the reverse or negative phase with that of the late 1888 to the middle of 1950 period. The reversals take place during the late 1873 to the negative, early 1888 to the positive, the middle of 1950 to the negative, and late 1966 back to the positive phase. For example, the reverse or negative pattern for 1951 to early 1966 is indicated in Figure 2 (The Ideal Timing Pattern in the Negative Phase).

Note that the 1951 peak is equivalent to the 1934 trough in reverse, 17 years earlier, i.e., a peak becomes a trough, and vice versa: 1953 as 1936, 1955 as 1938, 1957 as 1940, 1959 as 1942, 1960 as 1943, 1961 as 1944, 1963 as 1946, and early 1966 as 1949, but in reverse.

#### The “Positive” Phases Again

The ideal timing patterns for late 1870, 1871, 1872, and early 1873, and late 1966, 1967, and 1968, are in the positive phase, similar to the late 1888 to the middle 1950 period. Late 1966 is a trough in timing like 1932, 1967 is peak like 1933, and 1968 is like 1934. Since the reversal takes place in 1966, the year 1966 is both a major peak and a trough year, and this could account for the 1966 credit crisis year.



Sources: 1871-1897 (Cowles Index - All Stocks; Monthly Average)  
 1871-1968 (Dow Jones Industrials: 1897-1929, Monthly Average;  
 1930-1968; H-L Monthly).

Chart I. The Rhythmic Cycles of Optimism and Pessimism, 1870-1968 and Stock Market Prices, 1871-1968.



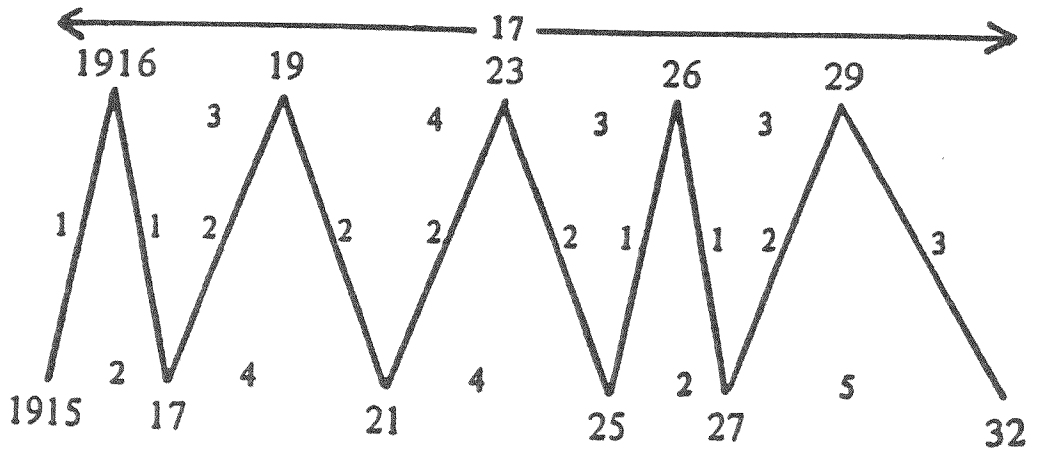


Figure 1. The Ideal Timing Pattern in the Positive Phase, 1915-32.

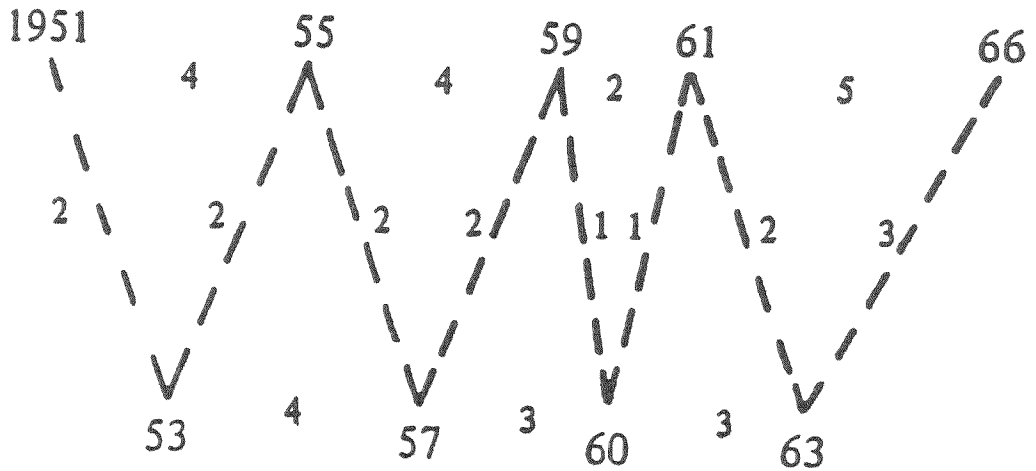


Figure 2. The Ideal Timing Pattern in the Negative Phase, 1951-66.

### *The 40-41 Month Cycle*

This ideal cycle pattern of optimism and pessimism explains the so-called “40-41 month average” stock market cycle. For example, during the 17 years from 1915 to 1932 there were five cycles for an average of 3.4 years (or 40.8 months) each; however, as indicated above, the ideal cycle ranged from approximately 2 years to 5 years. In other words, there is no 40-41 month cycle; 40-41 months (or 3.4 years) are merely the averages of the 2- to 5-year cycles over a period of 17 years (as shown in Figure 1).

### *The “Decennial Pattern”*

This ideal cycle discovery also explains the failures and coincidental successes of the “decennial pattern” theory of stock prices discovered by Edgar Lawrence Smith and followed by some stock market analysts. When the decennial pattern has been in phase with the rhythmic cycles, it has been successful, but when it has been out of phase, as in 1949, it has failed.

### *Chart I,B Shows the Ideal Timing and Amplitude Tendency*

Chart I,B shows the ideal timing and amplitude tendency of the rhythmic cycles of optimism and pessimism. An analysis of Chart I,B indicates that in the 1888-1950 period the ideal major declines start in 1895, 1912, 1929, and 1946. Also, the ideal large declines start in 1902, 1919, and 1936. At the other extreme, the ideal minor declines start in 1892, 1909, 1926, and 1943. Somewhat more important are the ideal declines that start in 1899, 1916, 1933, and 1967 and the declines from 1889, 1906, 1923, and 1940.

### *Major Turning Points at 7- and 10- or 6- and 11-Year Intervals*

The major ideal peaks of optimism in the positive phase tend to appear at alternating intervals of 7 and 10 years, i.e., 1895-1902 (7 years), 1902-1912 (10 years), 1912-19 (7 years), 1919-29 (10 years), 1929-36 (7 years), and 1936-46 (10 years).

The major ideal troughs in the positive phase are 6 and 11 years apart, i.e., 1915-21 (6 years), 1921-32 (11 years), 1932-38 (6 years), and 1938-49 (11 years).

In the reverse or negative phase the major ideal peaks are 6 and 11 years apart and the major ideal troughs are 7 and 10 years apart, i.e., peaks 1881-87 (6 years) and 1955-1966 (11 years); troughs 1878-85 (7 years) and 1953-63 (10 years).

The interval between three major peaks or three major troughs, as shown in the positive phase, is 17 years: 10 plus 7 (17 years), 11 plus 6 (17 years).

### *The Timing of the Next Phase Reversal*

Recent research findings, based upon the period prior to late 1870 (not shown in the charts), indicate that the ideal rhythmic cycle should change from the positive phase to the negative phase near the beginning of 1969. Consequently, this should result in an important stock market decline in 1969 and also a decline, first, in the “leading indicators” and then in the rate of growth of the “concurrent” and “lagging” indicators of business activity.

*The 1/4 and 1/12 of 17-Year  
Ideal Rhythmic Cycles in  
Stock Market Prices*

In addition to the ideal cycles that average  $1/5$  of 17 years (3.4 years, or 40.8 months), as shown in Charts I,A and I,B, there are also strong indicators since 1949 (not shown on the charts) of ideal average cycles of  $1/4$  of 17 years (4  $1/4$  years, or 51 months) and, since 1966 (not shown on the charts), of ideal average cycles of  $1/12$  of 17 years (1  $5/12$  years or 17 months).

The  $1/4$  of 17-year cycles (51 months) for the 17-year period from 1949 to 1966 have ideal major bottoms in the middle of 1949, late in 1953, late in 1957, in the middle of 1962, and late in 1966. The ideal bottom of the  $1/5$  of 17-year cycles is in early 1963. This single conflict may explain the double bottom in 1962.

The  $1/12$  of 17-year cycles (17 months) from 1966 to 1968 have an ideal top early in 1966, a bottom late in 1966, a top near the middle of 1967, a bottom early in 1968, and a top very late in 1968. An ideal bottom is indicated after the middle of 1969.

## 2

## *A Comparison of Actual Stock Prices, 1871-1968, With the Ideal Rhythmic Timing Patterns of Optimism and Pessimism*

### *The Timing of Actual Stock Price Tops and Bottoms*

Chart I,C shows the actual tops and bottoms of stock prices (1871-1968). The letter T indicates the year of the top and B the year of the actual bottom; E indicates that the actual top or bottom comes earlier than the ideal date; and L indicates that it comes later. This chart identifies the month of the top and the bottom, and the price.

### *The Actual Versus the Ideal Tops and Bottoms*

Chart II,A is a summary of the actual versus the ideal tops and bottoms in the positive phases.

1. Out of a total of 21 tops, 2 actual tops are earlier than the ideal, 2 are later and 17 are on schedule. Of the early tops, one is in the first part of the prior year (June 1901 versus the ideal 1902) and one is in the latter part of the prior year (September 1939 versus the ideal 1940). Both late tops are in the early part of the following year (February 1934 versus the ideal 1933 and March 1937 versus the ideal 1936).

2. Out of a total of 20 bottoms, 8 are early, none are late, and 12 are on schedule. However, of the 8 early bottoms, 6 are in October-December of the prior year, but 2—1923 and 1896—are two years early.

3. Many of the actual major tops seem to come in the latter part of the year—1919, 1929, 1936 (March 1937), and 1946. Many actual major bottoms seem to come in the early part of the year, such as in 1938, 1942, and 1949. This tendency may help to explain

the 6 bottoms that come 1 to 3 months prior to the ideal bottom year and tends to indicate the need for further research to determine the exact month or quarter of the ideal top and bottom; the ideal pattern that is shown is an approximate one since it indicates the cycles only on a yearly basis.

Chart II,B is a summary of the actual versus the ideal tops and bottoms in the negative phases.

1. Out of a total of 10 tops, 3 are late, none are early, and 7 are on schedule. Two late tops occur in the early part of the following year (April 1956 versus the ideal 1955 and January 1960 versus the ideal 1959). One double-tops in 1951-53.

2. Out of 11 bottoms, 7 are on schedule, 1 is late, and 3 are early. The 3 early bottoms are all in the prior June (1884, 1887, and 1962). In the 1951-66 period the on-schedule bottoms tend to come late in the year (1953, 1957, and 1960).

In the period 1871-1968 there are 62 actual turning points; 43 are on schedule versus the ideal, 13 are early, and only 6 are late; out of 31 tops, 24 are on schedule.

These figures demonstrate a relatively high degree of correlation, especially when it is recognized that no stock market index can be a perfect reflection of the ideal rhythmic cycles of optimism and pessimism. Moreover, it is possible that there could be a closer correlation if we knew the exact monthly or quarterly timing of the ideal rhythmic cycles.

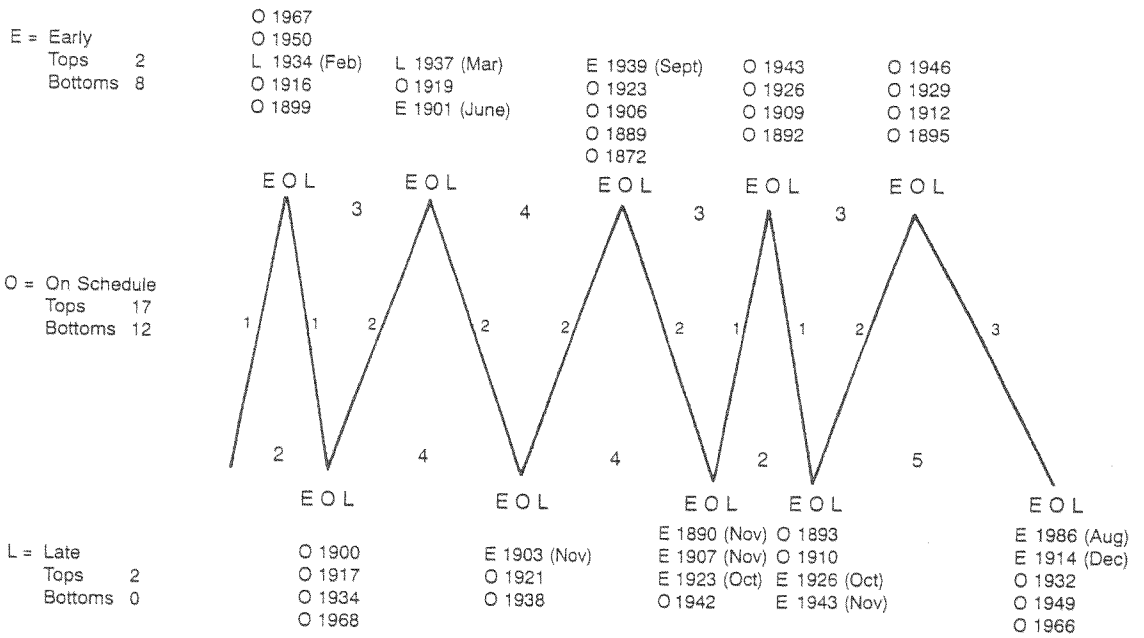


Chart II, A. Actual Verses Ideal Tops and Bottoms in Stock Market Prices-Positive Phase.

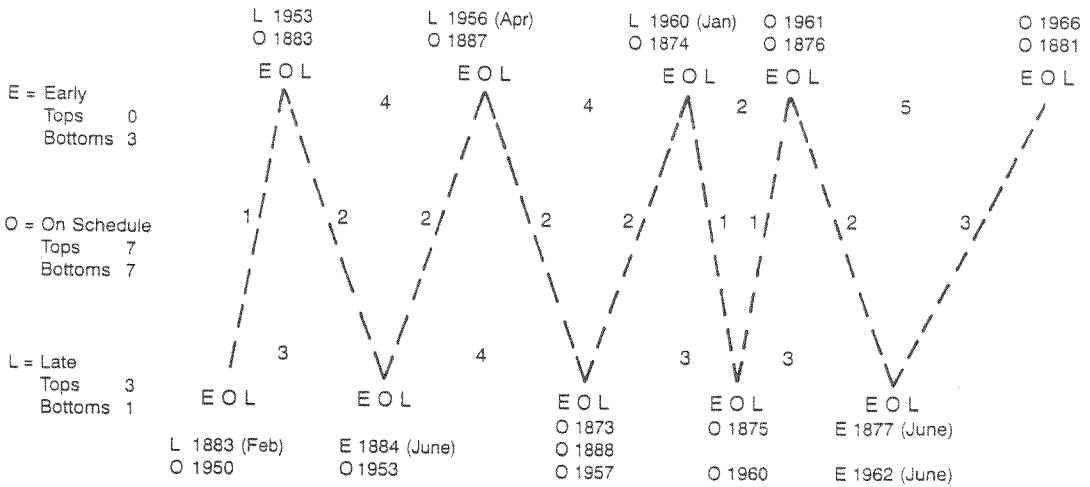


Chart II, B. Actual Verses Ideal Tops and Bottoms in Stock Market Prices-Negative Phase.

### *Major Turning Points at 7- and 10- and 6- and 11-Year Intervals*

The actual major tops in the long positive phase appear at alternating intervals of approximately 7 and 10 years; the interval between the 3 major tops is 17 years.

1895-June 1901	6 1/2 years (approx.)
June 1901-1912	10 1/2 years (approx.)
1912-1919	7 years
1919-1929	10 years
1929-March 1937	7 1/4 years (approx.)
March 1937-1946	9 3/4 years (approx.)

Actual major bottoms in the long positive phase appear at alternating intervals of approximately 6 and 11 years (except 1896-1903); the interval between the 3 major bottoms is 17 years.

1896-November 1903	7 years (approx.)
November 1903- December 1914	11 years
December 1914-1921	6 years (approx.)
1921-1932	11 years
1932-1938	6 years
1938-1949	11 years

In the negative phase the major tops are 1881-87 (6 years) and April 1956-66 (approximately 10 instead of the ideal 11 years); the major bottoms are 1877-84 (approximately 7 1/2 years) and 1953-62 (approximately 9 plus versus the ideal 10 years). In the short negative phases the regularity of the intervals between the stock market major tops and bottoms is inconclusive.

During the entire 1871-1968 period the widest deviation appears in the 1896 bottom versus the ideal of 1898. The ideal 3-year drop from optimism to pessimism from 1895 to 1898 produced a business crisis that started in 1895, but apparently the greatly increased production of gold reversed the

trend in late 1896. This would indicate that strong monetary factors are able to modify the ideal timing and amplitude cycle.

### *A Comparison of Actual Stock Prices With the Ideal Timing Amplitude Pattern*

A comparison of Charts I,B and I,C shows that the actual amplitude of major declines in 1895, 1912, and 1946 in the positive phase follows the ideal pattern. However, the actual 1929-32 drop is much larger than anticipated. In the negative phase the actual large advances up to 1881 and up to 1966 follow the ideal pattern.

Also, the actual declines follow the ideal declines from 1902, 1919, and 1936 reasonably well, as do the advances to 1887 and to 1955. At the other extreme, the actual declines are minor, as indicated by the ideal patterns in 1909, 1926, and 1943, but are larger than expected in 1892. At the next level there are moderate declines in 1899, 1933, 1950, and 1967, but the drop from 1916 to 1917 is larger than the ideal pattern.

Until we find another possible cause, we must attempt to explain the larger than the ideal declines in 1892, 1916, and 1929 in terms of prior excess stock market speculation and various fiscal and monetary factors.

It is well accepted that the amplitude of business and stock market cycles is, to a large extent, influenced by monetary and fiscal policies. However, it is interesting to note the influence of multiples of 17 years. The extreme boom high of 1929, in the positive phase, is 51 years (3 times 17) from the major depression bottom of 1878 in the negative phase, and the extreme bottom of 1932, in the positive phase, is 51 years after the major top of 1881 in the negative phase. Moreover, perhaps it is no coincidence that the 1967-68 gold crisis was 34 years (2 times 17) after the 1933-34 gold crisis.

## 3

## *A Comparison of the Actual Prices of a Cyclical Stock, TWA, With the Ideal Time-Amplitude Pattern of Optimism and Pessimism*

An inspection of Chart III (Trans-World Airlines, Inc.) shows how a so-called cyclical stock follows the ideal pattern of optimism and pessimism (Chart I,B) from 1932 to 1968, years which include the positive and negative phases of the rhythmic cyclical patterns.

### *The Actual Versus the Ideal Timing of Tops and Bottoms*

In the positive phase, 1932, 1933, 1934, and 1936 are on schedule; there is a double bottom in late 1937 and in early 1938 versus the ideal 1938; 1940, 1942, and 1943 are on schedule; there is a double bottom late in 1943 and in early 1944 versus the ideal 1944; the top comes in December 1945 instead of in the ideal 1946; a double bottom comes in late 1948 and in early 1949 versus the ideal 1949; there is a top in early 1950 and the beginning of a decline in 1950 on schedule.

In the negative phase from late 1950 to early 1966 the actual follows the ideal pattern every year except in 1963, when the actual bottom came in 1962 as a double bottom in June and October. In this so-called cyclical stock we see clearly the tops in 1951 and 1955, which are not so clearly apparent in the Dow Jones Industrial Index.<sup>40</sup> In 1966 the stock tops early in the year on schedule and drops into October 1966, when the ideal pattern reverses back to the positive phase for late 1966, 1967, and 1968. TWA makes a bottom in late 1966, a top in 1967, and a bottom in 1968 (March) on schedule.

### *The Actual Versus the Ideal Timing-Amplitude Tendency*

The amplitude of the actual prices follows the ideal pattern rather closely in both the positive and negative phases. There are major bottoms in 1932, 1938, November 1948 versus the ideal 1949, 1953, and 1962 versus the ideal 1963, and major tops in 1936, December 1945 versus the ideal 1946, 1955, and 1966.

In the positive phase the major bottoms are approximately 6 and 11 years apart (1932-1938-November 1948); the major tops are approximately 10 years apart (1936-December 1945), as in the ideal pattern. In the negative phase, the major top of 1955 is approximately 6 years after the positive phase bottom of November 1948 and 11 years before the early 1966 top, as in the ideal pattern. The major bottom of 1953 is approximately 7 years after the positive top of December 1945, but 9 years before 1962, instead of the ideal 10 years, since the 1962 bottom is early versus the ideal 1963; however, this was a major TWA bottom.

### *Rhythmic Investor Psychology a Major Factor*

On the whole, it appears that the ideal rhythmic cycles reflect changes in optimism and pessimism as they affect cyclical stocks. Consequently, a cyclical stock, such as TWA, follows the ideal pattern more closely than mixed averages, such as the Dow, Standard and Poor's, etc. The high degree of conformity of the actual TWA price pattern to the ideal pattern seems to indicate rather strongly that stock price cycles are not random events. It also confirms the premise that investor psychology is a major factor in the cyclical motion of stock prices.

<sup>40</sup> See Figure 3.

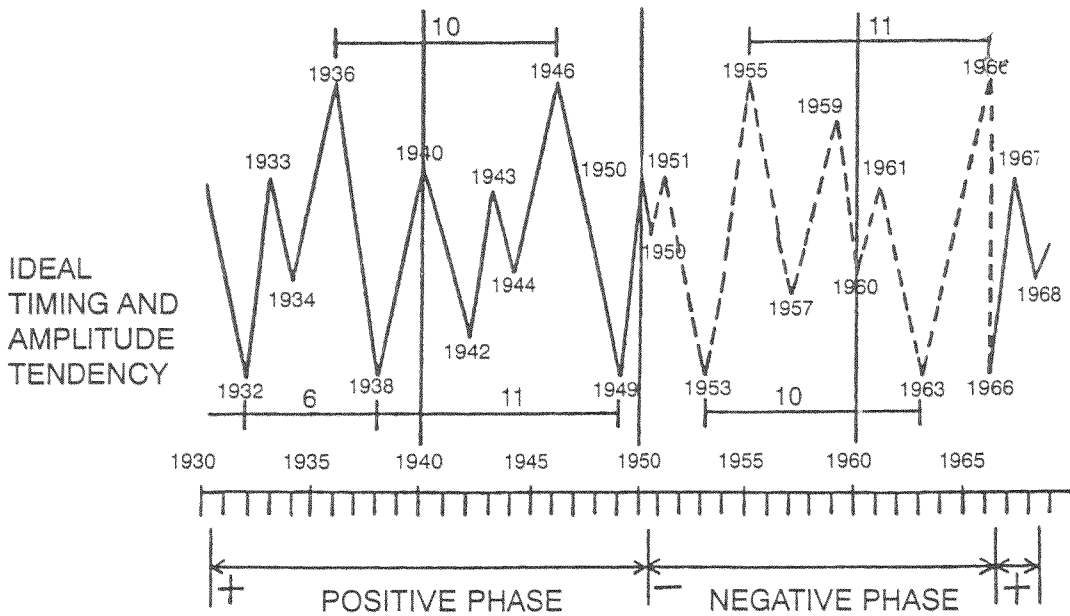
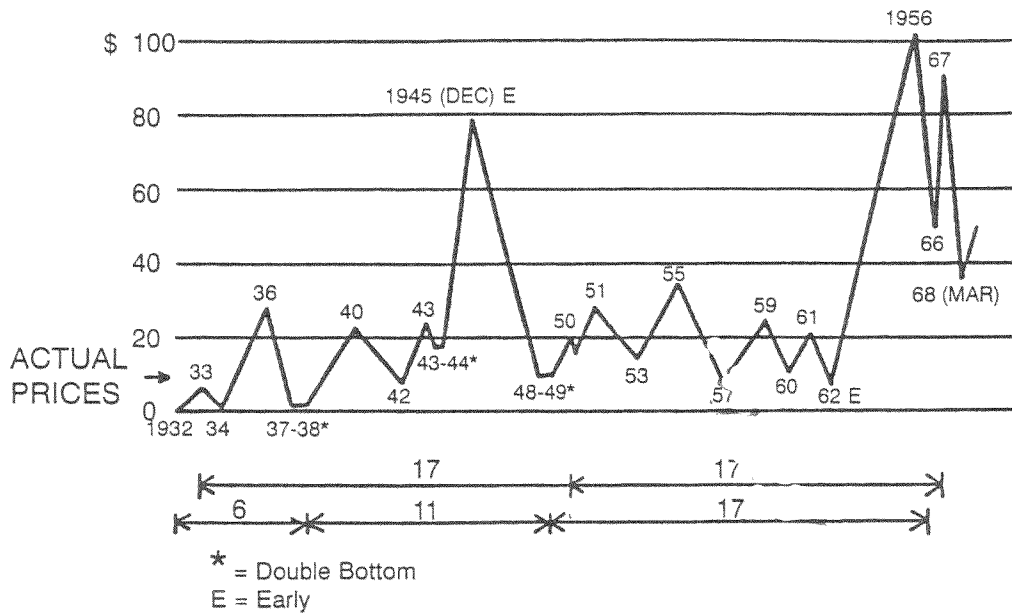


Chart III. Trans-World Airlines, 1932-68, Versus the Ideal Pattern.



*DOW JONES INDUSTRIAL AVERAGE*



*DOW JONES RAIL AVERAGE*

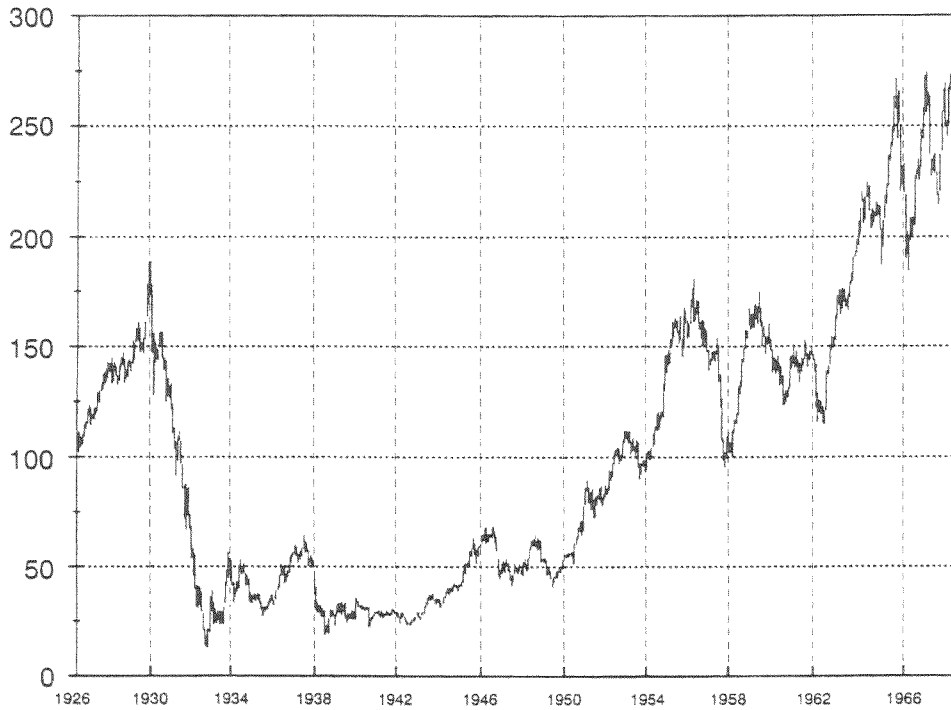


Figure 3

## 4

*The Random-Walk Theory of Stock Market Prices  
and the Rhythmic Cycles of Optimism and Pessimism*

The close correlation of both aggregate stock market prices and TWA stock prices with the rhythmic cycles of optimism and pessimism seems to refute the random-walk theory of stock price changes. This theory, first proposed by Bachelier,<sup>1</sup> implies that speculative prices fluctuate randomly about their intrinsic values and that historical data about the price of a stock or stock prices are of little help in forecasting future prices.

The random-walk hypothesis assumes an approximate Brownian motion, according to Osborne,<sup>1</sup> and states that the next move is independent of all past moves and that, therefore, knowledge of past price changes yields no significant information about future price changes. Roberts<sup>41</sup> infers that seemingly regular patterns are illusory and are the result of pure chance. However, Alexander<sup>1</sup> concludes that there are “trends” in stock market prices if the “move” is taken as the unit rather than “time”. Granger and Morgenstern<sup>1</sup> find, through spectral analysis, that while the simple random-walk model explains rather well the short-run movements of the stock prices, the model does not adequately explain the very important long-run movements. In fact, they find some evidence of a forty-month cycle, but only inconclusively, as one would expect from my prior comments on this cycle. The impression that one gets from the Cootner<sup>1</sup> selection of essays is that while the simple random-walk model does not fully describe the movements of stock prices, in modified form it is considered to be a reasonable approximation.

The rhythmic cycles of optimism and pessimism, at this stage, offer no theory or pattern for short-run movements, but they have produced empirical evidence that would seem to refute the random-walk hypothesis for long-run movements of stock prices.

---

<sup>41</sup> Cootner, Paul H. (ed). *The Random Character of Stock Market Prices*. Cambridge, Massachusetts: The M.I.T. Press (1964).

## 5

*The Money Supply, the Major Business Contractions,  
and the Ideal Rhythmic Cycles of Optimism and Pessimism*

Discussing money and business cycles, Friedman and Schwartz<sup>42</sup> state: "The outstanding cyclical fact about the stock of money is that it has tended to rise during both cyclical expansions and cyclical contractions . . . The only major exceptions since 1867 to the tendency of the money stock to rise during both cyclical expansions and cyclical contractions occurred in the years listed in the following tabulation, which gives also the percentage decline during each exception.

Years of Exception	Percentage Decline
1873-79	4.9
1892-94	5.8
1907-08	3.7
1920-21	5.1
1929-33	35.2
1937-38	2.4

In addition, there were two minor exceptions since the end of World War II:

1948-49	1.4
1959-60	1.1

The major exceptions clearly did not fall in a random subset of years. Each corresponds with an economic contraction that was major as judged by the other indicators; in the period covered there was no other economic contraction more severe than any in the list."

Friedman and Schwartz therefore conclude that the decline in the money stock was a major cause of the contraction in business activity in the periods listed.

In reply to this and subsequent papers by the Chicago School, Davis<sup>43</sup> states: "There is a real question as to whether anything can be inferred from the historical record about the influence of money on business if, as is argued in the next section, there is an important reverse influence exerted by the business cycle on the monetary cycle itself . . . The fact that the business cycle itself has an important role in determining the course of the monetary cycle seriously undermines the argument that the timing relationships of monetary cycles and business cycles point to a dominant influence of money on business. By the same token, ample room is left for the possibility that many other factors, such as fiscal policy, fluctuations in exports, and replacement cycles in consumer goods, may also exert independent influences on the course of business activity."

<sup>42</sup> "Money and Business Cycles," *The Review of Economics and Statistics* (February 1963).

<sup>43</sup> Davis R.G. "The Role of Money Supply in Business Cycles." Federal Reserve Bank of New York *Monthly Review*, (April 1968).

### *Rhythmic Cycles the Missing Links*

I suggest that the rhythmic cycles of optimism and pessimism are the "missing links" and were an important factor in the business contraction periods listed by Friedman and Schwartz. Every money and business contraction listed by Friedman and Schwartz and every advance from those declines were triggered by a rhythmic cycle change from optimism toward pessimism, and vice versa, as indicated on Chart I,B (Ideal Timing and Amplitude Cycles), as follows:

Years of Exception	Years of Ideal Cycle Decline
1873-79	1872-73 1874-75 1876-78
1892-94	1892-93
1907-08	1906-08
1920-21	1919-21
1929-33	1929-32
1937-38	1936-38
1948-49	1946-49
1959-60	1959-60

This empirical evidence would tend to support the proposition that while the money supply has an influence on business and business on money supply, the rhythmic cycles optimism and pessimism influence speculation and business expectations; "lack of confidence" adversely affects the willingness to lend, borrow (Chart IV, Ideal Cycles vs. Money and Credit), and spend on business investment and consumer durables, can lead to panics and runs on banks, and can precipitate major stock price declines. It therefore supports the "Keynes and Simons interpretations of 1929-33: they both argued that it is a collapse of confidence which sets off a demand for liquidity, that this demand

cannot be met but the attempts to meet it force liquidation, and that this liquidation includes bank loans with a resultant decline in the quantity of money. . . both Simons and Keynes emphasized the state of business expectations and the desire for liquidity."<sup>44</sup>

Moreover, the remarkable time correlations of money, business, and the rhythmic cycles during the years listed by Friedman and Schwartz are a further confirmation of the reality of the rhythmic cycles of optimism and pessimism.

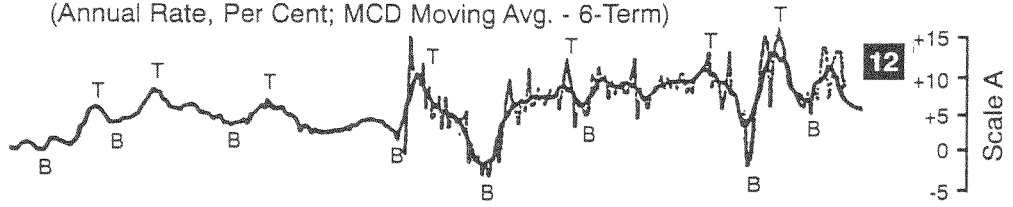
Furthermore, this new theory is consistent with the findings of Anderson and Jordon<sup>45</sup> that a change in Z is explained by factors other than monetary and fiscal forces, where Z is a variable summarizing all "other" forces that influence total spending. Their major conclusions are that fiscal actions have little influence upon total spending unless the deficit is financed by an increased money supply, but that changes in the money supply are a major influence. However, since it has already been shown that changes in the cycles of optimism and pessimism influence demand-induced changes in the money supply, the findings of Anderson and Jordon furnish additional evidence for the large role of the rhythmic cycles of optimism and pessimism on private spending.

<sup>44</sup> Davis, J. Ronaie, *American Economic Review* (June 1968).

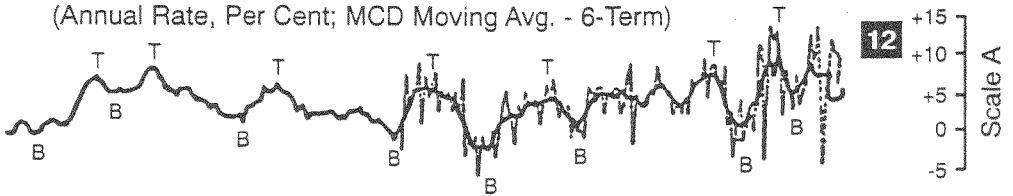
<sup>45</sup> Anderson, Leonall C, and Jordon, Jerry L, "Monetary and Fiscal Actions: A Test of Their Relative Importance in Economic Stabilization," *Federal Reserve Bank of St. Louis Review* (November 1968).

**Flows of Money and Credit**

98. Change in Money Supply and Time Deposits  
(Annual Rate, Per Cent; MCD Moving Avg. - 6-Term)

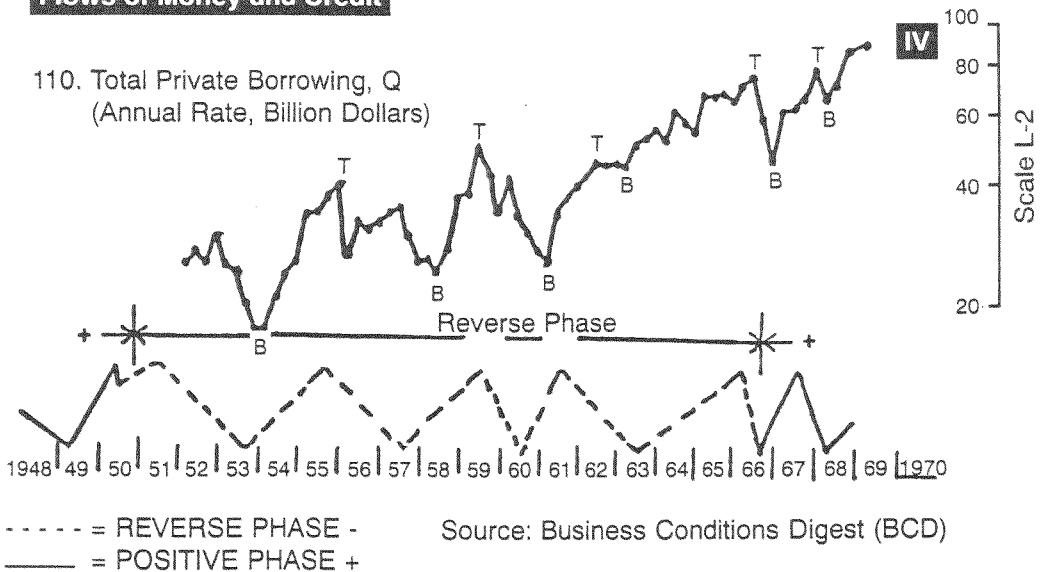


85. Change in Money Supply  
(Annual Rate, Per Cent; MCD Moving Avg. - 6-Term)



**Flows of Money and Credit**

110. Total Private Borrowing, Q  
(Annual Rate, Billion Dollars)



TIMING OF IDEAL CYCLES (Yearly Basis)

Chart IV. Ideal Cycles Versus Money and Credit.

## 6

*Some Leading Business Indicators  
and the Ideal Rhythmic Pattern*

The sensitive "Leading Business Indicators" (1948-68), as published in the Department of Commerce Business Condition Digest (formerly Business Cycle Developments), seem to correlate with the ideal rhythmic pattern in the positive and the negative phases to a degree that cannot be explained by chance or random behavior. The following BCD volatile series are suggested for comparison:

Series 1, Average Workweek, Production Workers, Manufacturing (hours). (Chart V.)

In the positive phase, 1949 is a bottom and on schedule versus the ideal cycle; there is a rise into the middle of 1950; and the start of a decline on schedule.

In the reverse phase, there is a rise from the middle of 1950 to a top in 1951 on schedule; a bottom very early in 1954 versus the ideal 1953; a top in 1955 on schedule; a bottom very early in 1958 versus the ideal 1957; a top in 1959 and a bottom in 1960, both on schedule; a top in early 1962 versus the ideal 1961; and a bottom in late 1963 and a top in early 1966, both on schedule.

In the positive phase, there is a bottom very early in 1967 versus the ideal late 1966; and a top in 1967 and a bottom in early 1968, both on schedule. The major discrepancy is in 1952.

Series 6, New Orders, Durable Goods Industries (bil. dol.). (Chart V.)

In the positive phase, 1949 is a bottom on schedule versus the ideal cycle; there is a rise into the third quarter of 1950 and the beginning of a decline on schedule.

In the reverse phase, there is a rise to a top in 1951 on schedule; a bottom in September 1953 and a top in December

1955, both on schedule; a bottom in January 1958 versus the 1957 ideal; a top in 1959 on schedule; a bottom in January 1961 versus the ideal 1960; a top in early 1962 versus the ideal 1961; a bottom in 1962 versus the ideal 1963; and a top in late 1966 versus the ideal early 1966.

In the positive phase, there is a bottom in early 1967 versus the ideal late 1966; a top in January 1968 versus the ideal 1967; and a bottom in 1968 on schedule.

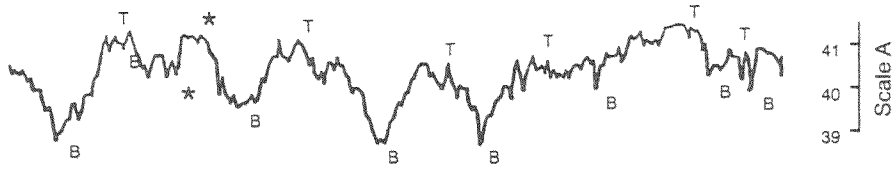
Series 21 (now Series 245), *Change in Business Inventories, All Industries, Q.* (ann. rate bil. dol. ). (Chart V.)

In the positive phase, there is a bottom in 1949 on schedule; a rise into 1950; and the beginning of a decline on schedule.

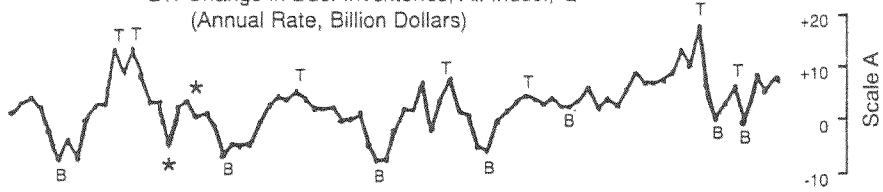
In the negative phase, there is a top in 1951, a bottom in 1953, and a top in 1955, all on schedule; a bottom very early in 1958 versus the ideal 1957; a double top in 1959 and early 1960 (because of the steel strike) versus the ideal 1959; a bottom very early in 1961 versus the ideal 1960; a top in the first quarter of 1962 versus the ideal 1961; a bottom in 1963 on schedule; and a top in late 1966 versus the ideal early 1966.

In the positive phase, there is a bottom in the second quarter of 1967 versus the ideal late 1966; and a top in 1967 and a bottom in the first quarter of 1968, both on schedule.

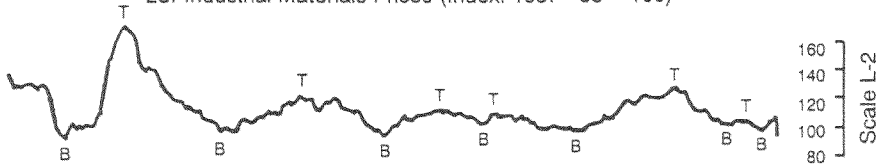
1. Average Workweek, Production Workers, Manufacturing (Hours).



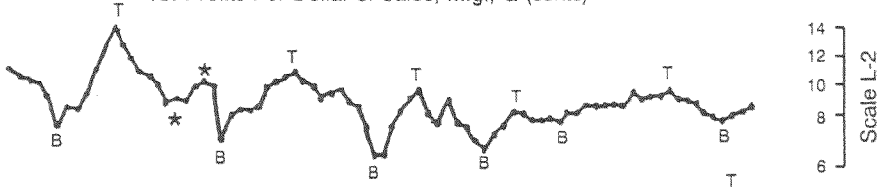
21. Change in Bus. Inventories, All Indus., Q (Annual Rate, Billion Dollars)



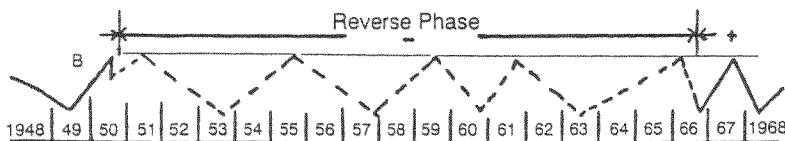
23. Industrial Materials Prices (Index: 1957 - 59 = 100)



18. Profits Per Dollar of Sales, Mfg., Q (cents)



6. New Orders, Dur. Goods Indus. (Billion Dollars)



Source: Business Conditions Digest (BCD)

TIMING OF IDEAL CYCLES (Yearly Basis)

Chart V. Ideal Cycles Versus the Leading Indicators.

Series 23, *Industrial Materials Prices* (Index: 1957-59 – 100). (Chart V.)

In the positive phase, there is a bottom in 1949 on schedule; a slight rise into 1950; and a plateau through early 1950.

In the negative phase, there is a rise to a top in 1951 on schedule; a bottom in February 1954 versus the ideal 1953; a top in December 1955 on schedule; a bottom in April 1958 versus the ideal 1957; and a top in 1959, a bottom in 1960, a top in 1961, a bottom in 1963, and a top in early 1966, all on schedule.

In the positive phase, the bottom is in 1967 versus the ideal late 1966; a slight rise to a top in both 1967 and early 1968; and a bottom in 1968, as with the ideal.

Series 18, Profits per dollar of Sales, manufacturing, Q. (cents). (Chart V.)

In the positive phase, there is a bottom in 1949 and a sharp rise into 1950 on schedule; however there is no start of a decline in 1950.

In the reverse phase, there is a sharp rise to a peak in the fourth quarter of 1950 versus the ideal 1951; a bottom in 1953 and a top in 1955, both on schedule; a bottom in the first quarter of 1961 versus the ideal 1960; a top in 1961, a bottom in 1963, and a top in the first quarter of 1966, all on schedule.

In the positive phase, there is a bottom in 1967 versus the ideal late 1966, and a continuation of the rise without a dip from 1967 into 1968. However, in Series 16, *Corporate Profits After Taxes, Q.* (ann. rate, bil. dol.), there is a bottom in the first quarter of 1967 versus the ideal late 1966, and a top in the fourth quarter of 1967 and a bottom in the first quarter of 1968, both on schedule.

In Series 1, 21, 18, and 6, the 1952-53 distortion is not forecast by the ideal cycle. It was caused by the sharp drop in automobile sales from 1950 to 1952 during the Korean War and then by the sharp rise from 1952 to 1953 (see Series 234, *Automobile Sales*, and Series 113, *Change in Consumer Installment Debt*).

### ***Money and Credit Reflect Rhythmic Cycles***

Special attention is again directed to Series 85, *Change in Money Supply*, Series 98, *Change in Money Supply and Time Deposits*, and Series 110, *Total Private Borrowing* (Chart IV), in view of the many recent articles on the role of the money supply in business cycles. These series follow the ideal rhythmic pattern to such a high degree that it would seem that the ideal rhythmic cycles of optimism and pessimism influenced the timing of cycles in private borrowing and in the demand-induced money supply; the turning points in money are generally earlier because of the monetary moderating action by the Federal Reserve. While "changes" in money supply had an influence upon business and business upon the demand-induced money supply, it is seen here that the rhythmic cycles of optimism and pessimism had an important influence upon expectations and upon the timing and amplitude of private borrowing and business. On the other hand, it would appear that fiscal and monetary policy influenced the amplitude and timing of the money supply and then the business cycles in varying degrees, depending upon the action taken and the confidence, liquidity, and ingenuity of the lenders, borrowers, and spenders. Perhaps prior knowledge of the ideal rhythmic cycles could have avoided the unnecessary sharp changes in monetary and fiscal action during 1966, 1967, and 1968.



***What Happens When Rhythmic Cycles Reinforce or Oppose Fiscal and Monetary Action***

In view of the degree of correlation between the leading business indicators and the ideal cycles, it is suggested that the long rhythmic cycle of optimism from 1963 to 1966 was a major factor in the 1963-66 boom, in addition to the important tax measures and monetary expansion. Moreover, the rise of the ideal cycle of optimism from its early 1968 bottom explains the 1968 advance of stock prices and the "unexpected" sustained high in consumer spending and, especially, in business lending, borrowing, and spending through the spring of 1969, despite the influence of the tax surcharge, high interest rates, and a tight monetary, fiscal and debt management policy.

It seems that we must conclude that the business cycle still exists in the private sector and that stock prices and both consumer and businessmen's expectations, spending, borrowing, and bank lending are influenced by changes in optimism and pessimism that are rhythmic in nature. In fact, at the same time that optimism and pessimism influence stock prices, major stock price changes, as an early indicator and through realized and "paper" profits and losses, in turn influence and reinforce expectations, spending, borrowing, and lending both upward and downward.

***Business Depressions, Emotional Depressions, and the Rhythmic Cycles of Pessimism***

It is also interesting to note that psychiatric research indicates a correlation between business depressions and the peak periods of emotional depressions and the rhythmic

cycles of pessimism. Brenner<sup>46</sup> finds that fluctuations in mental hospital admissions show strong inverse correlations with fluctuations in the employment index in New York State over the period 1910 to 1960. Therefore, since it has been shown that both employment and economic activity show a strong positive relationship to the ideal rhythmic cycles of pessimism, we have evidence here for the speculation that the rhythmic cycles of pessimism are related to both emotional and business depressions.

Consequently, more knowledge about the rhythmic cycles of optimism and pessimism should improve the proficiency in economic forecasting, which is so important for any "New Economics." Moreover, this knowledge would be valuable for longer forecasts of 3 to 5 years; most present methods are not designed for this objective. While structural and institutional changes in the United States economy seem to have made the business cycle more stable since 1946, there is no certainty of a continuation of stability in the future.

---

<sup>46</sup> Brenner, M.H., "Economic Change and Mental Hospitalization: New York State, 1910-1960," *Social Psychiatry*, 2:4 (1967).

## 7

*The Possible Origins of the Rhythmic Cyclical Patterns**The Overlapping Rhythmic Cycles and the Timing of Reversals*

The ideal composite timing and amplitude cycles (Chart I,B) seem to be a synthesis of overlapping rhythmic cycles that produce the rise and decline in terms of time and amplitude and trigger the turning points. Chart VI,A,B (*Overlapping Rhythmic Cycles and Timing of Reversals*) illustrates the ten overlapping rhythmic cycles, each with tops and bottoms 17 years apart. The letter R on Chart VI indicates when the cycle is in the reverse or negative phase, shown reversed as dotted lines on Chart I,A,B. Chart VI,A, lines 1-5, show, on a yearly basis, the timing, duration, and amplitude tendency of declines in the positive phase and advances in the R or negative phase. Chart VI,B lines 1-5, show, on a yearly basis, the timing, duration, and amplitude tendency of advances in the positive phase and declines in the R or negative phase.

*Declines in the Positive Phase and Advances in the Negative Phases*

Chart VI,A, line 1, in the positive phase, shows on a yearly basis the ideal declines of one year from 1899 to 1900, 1916 to 1917, 1933 to 1934, and 1967 to 1968. Since 1950 is a reversal year, it is both a top and a bottom. In the negative R phase, line A1, 1882 to 1883 becomes an advance; likewise, 1950 to 1951 in the R phase is an advance.

A2, in the positive phase, shows the major ideal declines of three years from 1895 to 1898, 1912 to 1915, 1929 to 1932, and 1946 to 1949. In the negative R phase, 1878 to 1881 and 1963 to 1966 become major ideal advances.

A3, in the positive phase, shows the ideal declines of two years from 1889 to 1891, 1906 to 1908, 1923 to 1925, and 1940 to 1942. In the positive phase, 1872 to late 1873 is a decline. In the R phase, 1874 becomes a top after a rise from 1873, the reversal year; likewise, in the R phase, 1957 to 1959 becomes an advance.

A4, in the positive phase, shows the major ideal declines of two years from 1902 to 1904, 1919 to 1921, and 1936 to 1938. In the R phase, 1885 to 1887 and 1953 to 1955 become major ideal advances.

A5, in the positive phase, shows the ideal declines of one year from 1892 to 1893, 1909 to 1910, 1926 to 1927, and 1943 to 1944. In the R phase, 1875 to 1876 and 1960 to 1961 become advances.

Each 1-, 2-, or 3-year movement is followed by a 16-, 15-, or 14-year movement to complete a 17-year cycle.

*Advances in the Positive Phases and Declines in the Negative Phases*

Chart VI,B, line 1, in the positive phase, shows on a yearly basis ideal advances of one year from 1891 to 1892, 1908 to 1909, 1925 to 1926, and 1942 to 1943. In the R phase, 1874 to 1875 and 1959 to 1960 become declines.

B2, in the positive phase, shows the ideal major two-year advances from 1893 to 1895, 1910 to 1912, 1927 to 1929, and 1944 to 1946. In the R phase, 1876 to 1878 and 1961 to 1963 become declines.

©2009 GUYAN

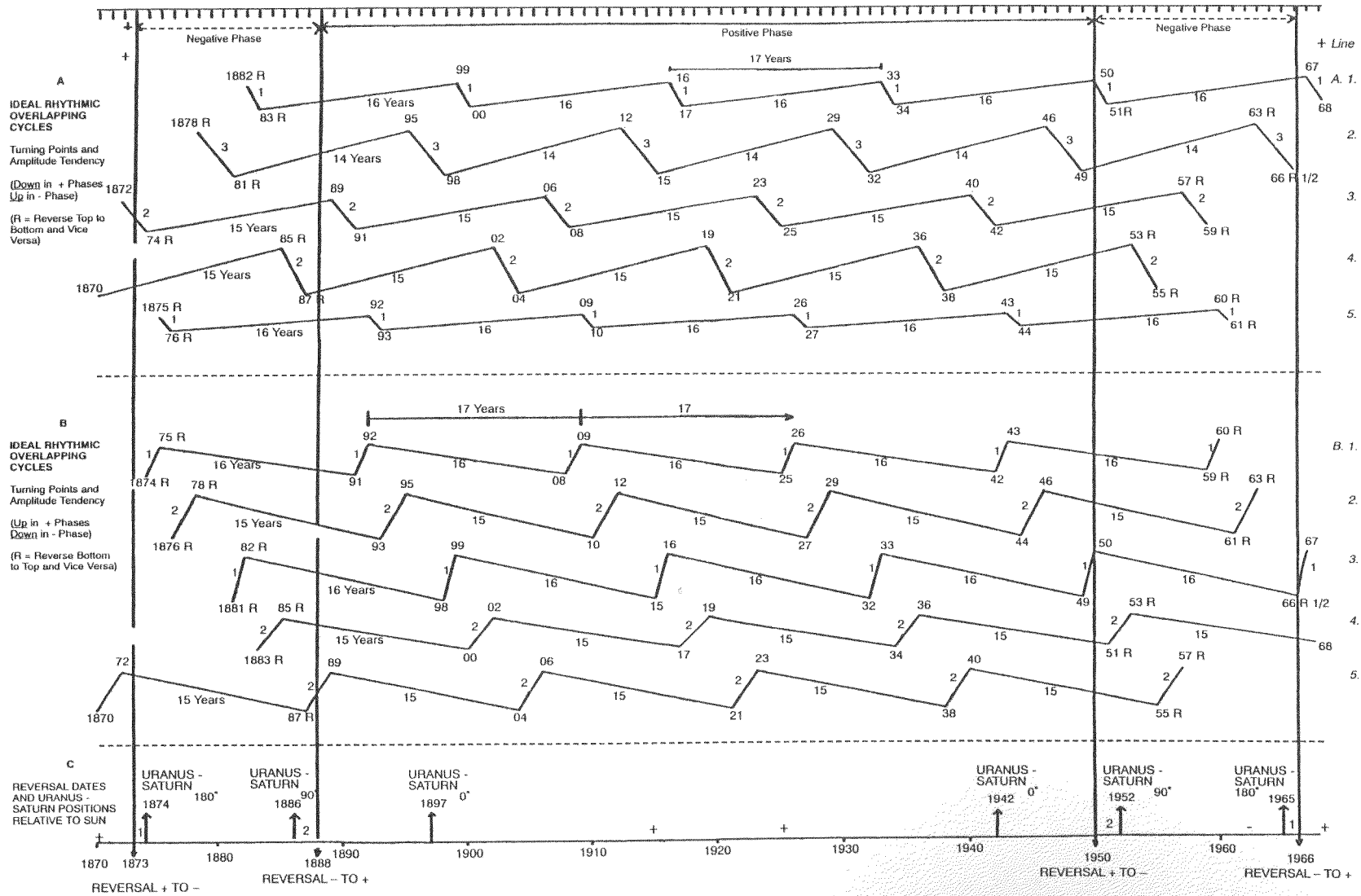


Chart VI. Overlapping Rhythmic Cycles and Timing of Reversals.

B3, in the positive phase, shows the ideal one-year advances from 1898 to 1899, 1915 to 1916, 1932 to 1933, 1949 to 1950, and late 1966 to 1967. In the R phase, 1881 to 1882 becomes a decline.

B4, in the positive phase, shows the ideal two-year advances from 1900 to 1902, 1917 to 1919, and 1934 to 1936. In the R phase, 1883 to 1885 becomes a decline.

B5, in the positive phase, shows the ideal two-year advances from 1870 to 1872, 1904 to 1906, 1921 to 1923, and 1938 to 1940. In the R phase, 1887 to early 1888 is a reversal year. In the positive phase, 1888 to 1889 is an advance.

The major ideal tops of 1895, 1912, 1929, and 1946 are in the same series (A2), each 17 years apart. The major ideal bottoms of 1898, 1915, 1932, and 1949 are in the same series (B3), each 17 years apart. The major tops of 1902, 1919, and 1936 are in the same series (A4). The major bottoms of 1904, 1921, and 1938 are in Series B5. In the R phase, tops become bottoms and vice versa. The major ideal tops of 1881 and 1966 and the major ideal bottoms of 1878 and 1963 are in the same series (A2).

The many repetitions and correlations of the ideal and actual cycle patterns in terms of timing, duration, and amplitude tendency in the positive and negative phases would seem to point to non-random causes. This thesis is also supported by the fact that the 1873-88 reverse-phase pattern returns in the same timing form in the 1950-66 reverse-phase period. Moreover, the cycles of optimism and pessimism tend to persist and correlate to a high degree, regardless of war or peace or technological changes over a period of nearly a hundred years.

### *Emotions of Optimism and Pessimism May Be Influenced by Solar System*

Medical-space research will be required to determine the exact mechanisms by which the emotions of optimism and pessimism are influenced; however, we can speculate that changes in electromagnetic forces or other changing patterns of solar system emissions and fields of force may be involved which could operate on the psychology of man through neurological and/or biochemical processes. It has long been known, for example, that changes in the ionization of the air can produce powerful physical, mental, and emotional effects.<sup>47</sup> Takata has found that the composition of human blood changes in relation to the sunspot cycle, to solar flares and sunrise, and to eclipses.<sup>48</sup> Jose concluded that certain dynamic forces exerted on the Sun by the motions of the planets were the cause of solar activity.<sup>49</sup> Bjorn, Hasseltine, and Pimm have developed techniques for the prediction of mean sunspot numbers using planetary influences.<sup>50</sup> Space research is discovering many planetary-solar-terrestrial relationships which may provide a key to the mechanisms involved.<sup>51</sup>

Many years of medical-ionization research for my paper, "Seasonal Cycles of the Common Cold and Their Relationship to Susceptibility,"<sup>52</sup> and my astronomy and

<sup>47</sup> See Appendix B, "Seasonal Peaks of Common Cold Incidence and Sunspot Activity."

<sup>48</sup> Takata, Maki, *Time Magazine* (March 21, 1969).

<sup>49</sup> Jose, Paul D., "Sun's Motions and Sunspots." *Astronomical Journal*, 70:3 (April 1965).

<sup>50</sup> Bjorn, T. Jr., Hasseltine, C.C., Pimm, R.S., "Prediction of Mean Sunspot Numbers Using Planetary Influences," American Geophysical Union, Annual Meeting, 1969.

<sup>51</sup> Gauquelin, Michael, *The Cosmic Clock*. Chicago: Henry Regnery (1967).

<sup>52</sup> *Journal of Cycle Research* (1955): on file in the New York Academy of Medicine.

planetary-solar-terrestrial research as a member of the American Geophysical Union and the New York Academy of Science, lead me to speculate that the rhythmic cycles may be related to the rhythmic movements of the planet Uranus relative to Saturn in their rotations around the Sun. Each of the 17-year rhythmic overlapping cycles seem to be related to the 45.36-year synodic period of Uranus and Saturn. The synodic period is the interval between two successive conjunctions ( $0^\circ$ ) of the two planets relative to the sun. The 17-year period is equivalent to almost exactly  $\frac{3}{8}$  of the 45.36 period ( $\frac{3}{8}$  of 45.36 is 17.01).

### ***Rhythmic Cycle Reversal Dates and Uranus-Saturn Positions***

The Uranus-Saturn hypothesis appears to be strongly supported by the dates of reversal from the negative to the positive phases, and vice versa (Chart VI,C, *Reversal Dates and Uranus-Saturn Positions*). The reversals in 1873, 1888, 1950, and 1966 appear to be related to the  $180^\circ$  and  $90^\circ$  positions of Uranus to Saturn relative to the Sun. As noted on Chart VI,C, the reversal in 1873 took place approximately 1 year before the Uranus-Saturn  $180^\circ$  position in 1874; the early 1888 reversal occurred approximately 2 years after the Uranus-Saturn  $90^\circ$  position of early 1886. In a similar manner, the 1950

reversal took place approximately 2 years before the Uranus-Saturn  $90^\circ$  position of early 1952 and the 1966 reversal occurred 1 year after the Uranus-Saturn  $180^\circ$  position of 1965. *In the 1870-1968 period the actual cycles and the ideal rhythmic cycles of optimism and pessimism in the positive and the negative phases appear to form a symmetrical pattern relative to the Uranus-Saturn  $180^\circ$  and  $90^\circ$  positions of 1874-86, respectively, the  $0^\circ$  of 1897 and 1942, and the  $90^\circ$  and  $180^\circ$  positions of 1952-1965, respectively. This symmetry of the actual and ideal cycles in both the negative and positive phases tends to confirm a rhythmic pattern rather than chance or random events.*

### ***A Major Research Project Needed***

A major scientific-economic research project is suggested to confirm this new theory; to test its findings versus the random-walk theory; to determine the exact quarterly or monthly turning points of the overlapping and composite cycles; and to investigate the specific cause of the 17-year patterns. In the meantime, it will be interesting to note the degree and duration of fiscal and monetary actions that are needed to overcome and modify the influence of the timing and amplitude of the ideal rhythmic cycles of optimism and pessimism.

## 8

*Conclusions and Implications*

The relatively high degree of timing, sequence, and amplitude tendency correlations between actual stock prices, other leading business indicators, private borrowing, and major business contractions and the ideal rhythmic patterns seem to confirm the existence of rhythmic cycles of optimism and pessimism rather than chance or random events as casual factors. It seems to refute the random-walk theory of stock price changes. This new theory is supported by the long series of rhythmic 17-year patterns, as illustrated in the composite and individual overlapping rhythmic cycles in both the positive and negative phases. It appears that the causation of these rhythmic cycles and their phase reversals is of solar system origin and may be related to the rhythmic movements of the planets Uranus and Saturn relative to each other and to the sun.

Monetary and fiscal policies do not appear to be the primary major causes of the business cycle, but appear to modify the amplitude and, to some extent, the timing for better or worse, depending upon the correctness of their timing, the strength of the action, and the concurrent influence of the confidence, liquidity, and ingenuity of lenders, borrowers, and spenders. It would appear that 1929 and 1932 would have been major turning points regardless who had been president. Despite the importance of the influence of military and political decisions upon the economy, the business cycle in the private sector still persists.

The existence of rhythmic cycles of optimism and pessimism implies that economics is more of a science than has been recognized. It is therefore recommended that a major scientific research project be undertaken by the economic, medical, and space agencies of the federal government, in collaboration with universities and private research organizations, to determine a more accurate timing of the rhythmic cycles of optimism and pessimism and their phase reversals, and also to investigate the precise mechanism by which changes in the solar system's fields of force influence the human emotions of optimism and pessimism.

Cycle theory based upon the evidence presented here, together with further research to refine and project the cycles into the future, should be of valuable assistance in solving short- and long-range forecasting problems and in guiding fiscal action and monetary management for economic growth and stability and for a better balance between the objectives of full employment and price stability.

*Appendix A*

At the present time the status of business sentiment is the most important factor underlying the current situation. More than ever, the psychological factor is at work. Therefore, although we might speak of various favorable and unfavorable factors as though they were independent forces, it should not be overlooked that the importance of most of these factors lies in their stimulating or depressing effect upon business confidence. It should also be realized that these various factors are so closely interrelated that changes in one lead to a series of changes in many of the others.

*Unfavorable Factors*

Without doubt, the most unfavorable factor at present is the deeply entrenched "fear of further decline" in the minds of businessmen. As long as this lack of confidence exists, we cannot expect capital to flow into new enterprises, or purchases of new equipment and commitments of any sort to be made.

At present we find that purchasing agents are deferring 1938 buying, awaiting a further working off of inventories, which are still high in many industries. Buying is being held to a hand-to-mouth basis. Normally, contracts for 1938 supplies are signed at this time of year, but now they are being deferred until after January 1. This is perhaps unfortunate, for these are the fellows who must start the ball rolling again. It is the purchasing agents who help keep the capital goods industries going. A high rate

*Favorable and Unfavorable Factors in the Business Outlook and Their Influence Upon Business Confidence*

(A paper submitted at the Harvard Business School, November 26, 1937.)

of production in the capital goods industries increases purchasing power for consumer

goods and leads to further stimulation of capital goods.

It is thus evident that whatever might dampen the confidence of the users of capital goods is of the utmost importance. In this region we find a number of unfavorable factors. In the first place, inventories are still high, and unfilled orders are practically nil. Moreover, commodity prices, especially raw materials, are still falling. This has a tremendous psychological effect, for when prices are falling, buyers are certain to hold off, so that prices fall still farther without possibility of immediate adjustment. Thus the volume of industrial production continues to decline, and this decreases the ability of the people to buy. This is evidenced by the present decline in payroll and, thus, in purchasing power.

Furthermore, the incentive for private capital to flow into industry on a large scale is weakening. The profit margins of many corporations are narrowing as a result of high costs, especially labor, and corporate inability to raise selling prices in the face of consumer resistance to a higher cost of living. Corporations are thus hesitant now about further expansion. This hesitancy is no doubt influenced by the tax on undivided profits. The reason is obvious. A few courageous businessmen, however, are still willing to take a chance at expansion, but they find that the slump in stocks and bonds has made new financing almost impossible. Recent new flotations are finding

themselves on the shelves of the investment houses.

Can hope be expected to be offered by the railroad, automobile, or building industries?

In the railroad industry, we find that recent wage increases have practically crippled most roads, despite increased rates. To this is added the reduction in income because of the falling off in car loadings. The purchase of new equipment is being definitely postponed. Moreover, the industry is laying off countless workers.

The automobile industry has been watched eagerly during the past month. Much hope for a stimulus to business was placed on this industry for it is a huge purchaser of materials—steel, copper, glass, etc. But at the present time, we find that the automobile industry may disappoint us, for the response to the new models does not appear to be very encouraging.

In the building industry, the rate of decline is rapid. Despite a rise in rents through September, the high costs of building construction are still frightening away the speculative builders. To be sure, building is dependent to a great extent upon general business, but, at the same time, construction by builders who are confident that there is a need and a pressing demand for housing can stimulate other industries and directly and indirectly increase employment and purchasing power.

And so, steel operations are down to about 33 per cent of capacity. This low rate of operation is a depressing force, for besides resulting in unemployment and curtailment of expansion, it spreads fear to other industries. Wide fluctuations are a natural phenomenon in this industry, but this fact is not fully realized at this time.

Speaking again of confidence, we cannot overlook the stock market. Without doubt, the rapid collapse of stock prices was chiefly responsible for the sudden relapse of

business sentiment. The current decline is further aggravating the situation. With reference to the stock market slump, in addition to its effect upon new financing and business sentiment in general, it is having an unfavorable effect on the will to buy of investors who are finding that their huge "paper profits" are being wiped out.

Turning to purchasing power, we find that there is a continuous decline. National income leveled off some time ago and is now drifting downward. The decline in government spending has, no doubt, been a factor. As a result, retail trade is becoming less optimistic and is not holding up to expectations. Although consumer purchasing power is mainly dependent upon industrial production, the opposite is also true.

In this area we also find that the current trend of farm income is downward as a result of declining prices of farm products.

In the realm of labor, unfavorable developments are again taking place. Strikes are again breaking out in the automobile and rubber industries. This is by no means a healthy tonic for business sentiment.

In the money and banking situation, we should not overlook the declining volume of bank credit. Although it may be an indication of the working off of inventories, it is deflationary. As long as the supply of money and credit in circulation continues to decline, there will continue to be a decline in business spending. We should also note that the effect of the recent outflow of gold is deflationary.

In the international situation, we can probably always expect something unfavorable, but at the present time there is a decline in the rate of armament expansion, with a resultant slowing down of many dependent industries. As we are now well aware, business conditions in Europe greatly concern us because of financial interrelationships and because the price of



many commodities is set in the world markets.

### *Favorable Factors*

Here again we find that the more important factors for the near-term outlook are those which directly influence business sentiment.

It is from this angle that recent government statements and actions are important. Business must have reason to feel that the administration is willing to cooperate. The actions of the President and Congress during the past week or more and in the near future may be able to turn the trend of sentiment.

Cooperation is being extended along several lines. In the first place, the President has promised the utilities that they can proceed with expansion without fear of government oppression, if they are willing to accept his theory of rate setting. It is estimated that cooperation with the utilities may release one to two billion dollars of capital expenditure. Already the New York State power companies have made plans for an outlay of \$112,000,000 during the next two years. If other utilities will follow suit, the estimated expenditure will give strong impetus to industrial activity and purchasing power. It might be pointed out, however, that with the present decline in the bond market, utilities will have a difficult time trying to float new issues.

Then again, the government has agreed to modify the undistributed profits tax and perhaps the capital gains tax. Already the House Ways and Means Committee has approved changes in the undivided profits tax which will be helpful at the present time, for it will lift some of the obstacles to expansion, particularly in the financially weak companies.

A reduction in the capital gains tax, as is intimated, would stimulate the pouring of private capital into industry. A huge store of

potential spending power is now lying idle in bank vaults or in tax-free securities, waiting for the profit incentive to be strengthened.

Moreover, the President is planning to initiate a huge housing program. It is his intention to encourage the formation of large-scale construction corporations financially strong enough to carry on mass building projects. He may also accept the responsibility for controlling building costs. As has already been indicated, this action would tend to stimulate other industries, as well as directly adding a vast number of men to the ranks of the employed. However, if the government attempts to drop relief and other expenditures to balance the budget, municipal costs will continue to rise and threaten higher real estate taxes. Also, residential building depends mainly upon general business conditions and their effect upon the would-be house owner, so that attempts to stimulate construction of housing directly may prove to be difficult.

Another favorable factor may be the intention to revive RFC lending. This would help railroads finance needed capital improvements at a time when income is very low. Also, managements are anticipating ICC permission to further raise rates to offset wage increases.

In the realm of government action, the present negotiations with Great Britain for a reciprocal trade agreement would stimulate exports.

It should be realized that it may take time for the government to actually carry out its plans, but a definite decision to act will in itself buck up business sentiment.

Turning to industry itself, we find encouragement in the fact that inventories are being worked off, because of the prompt adjustment of production to the lowered demand. This means that as soon as sentiment improves, production will quickly respond to increased demand. Also, there

has been no overexpansion of production facilities in the leading industries. Furthermore, most of the leading companies are in a strong financial position. These facts are important because they indicate that most corporations will not blindly attempt to sell their products at almost any cost in the hope of getting some contribution to overhead and preventing themselves from going under.

In the labor situation there is some hope, despite the recent outbreak of strikes. The present negotiations between the CIO and the AFL may lead to more conservative labor activities, for much of the strike activity is the result of a battle for leadership between the two organizations. The recent defeat of the CIO candidates in the Detroit elections might slightly dampen the confidence of CIO heads.

As for agriculture, there are some favorable aspects. Despite the continuous decline in the price of most farm products, farm income is still ahead of last year. As a result, it is anticipated that farmers will be in the market for an increased amount of farm equipment, clothing, etc. Furthermore, the President's desire to assist the farmer at this time may be helpful in maintaining his purchasing power.

In the security markets we find more steadiness than last month. The market has probably already over discounted the present decline in business. The day-to-day movements seem to be greatly dependent upon government action, which bears out our opinion that government action is now extremely important in stimulating business confidence.

The greater steadiness of the market may be partly due to the revised margin requirements. The action by the FRB indicates that Washington is greatly concerned over the unfavorable trend in securities and realizes its effect upon general business.

In the money and banking situation there are certain bright spots. Excess reserves are still large and interest rates are low, thus providing a large base for credit inflation. The rediscount rates charged by the FRB are exceedingly low; this offers some assurance against deflation. It is true that bank credit is declining rapidly, but, as has been noted, the downtrend of bank loans may be a favorable sign, indicating that business is reducing inventories. Some writers point with alarm at this decline in bank credit and consider it to be a major cause of the business decline. There is no doubt that the decline in investment holdings by the banks is deflationary, but if it continues, I believe the FRB will take steps to reverse the trend. It appears that the Federal Reserve Board will keep itself fully awake during the next few months.

As for the international situation, there is more reason for hope than for fear. The high state of tension that prevailed in Europe during the summer is gradually subsiding. Our nervousness over the possibility of a major war now is greatly abated. This is taking a great load off the minds of both the administration and businessmen.

Finally, all the members of the House and a third of the Senate face election next fall. These officeholders will attempt to do something to which they can point with pride. Such efforts would be definite action that would put the brakes on the present business decline.

## Appendix B

The phenomena of September-October and February-March peaks, on average, for both the common cold and sunspot activity appear to be related through the mechanism of ionization produced by X-radiation. The resultant decreased CO<sub>2</sub> absorption by the blood plasma, the acid-alkaline imbalance, and impaired oxygen consumption lower resistance and provide an environment for common cold viruses to attack.

Studies of the common cold indicate that two peaks of incidence often occur during the year—a major one, on average, between September and October, and the other between February and March. The peaks of incidence, noted in a study by Torney and Lake<sup>53</sup> of employees of Macy's department store in New York City, occurred in October and February. Downes<sup>54</sup> found a big peak in September and one in February-March among persons of ages 19 and over as well as ages 5-18, in a study conducted in Westchester County, New York. Dingle<sup>55</sup> found a September peak among a Cleveland, Ohio group. On the basis of years of research, Dr. Perrin Long of the Department of Medicine of the Kings County Hospital, considers the phenomenon of the September-October and February-March peaks, rather than one continuous peak from September to March, as one of the greatest mysteries of the common cold.<sup>56</sup>

<sup>53</sup> Torney and Lake, *Journal of the American Medical Association*, 117 (1924-1941).

<sup>54</sup> Downes, *Memorial Fund Quarterly*, 30 (1952).

<sup>55</sup> Dingle, John, "A Study of Illness in a Group of Cleveland Families," *Journal of Hygiene* (January 1953)

<sup>56</sup> Dr. Long's presentation of this mystery inspired the research for this paper.

## Seasonal Peaks of Common Cold Incidence and Sunspot Activity<sup>57</sup>

Studies of sunspots indicate that there are often two similar peaks—one, on average, between September-October, and the other, on average, between February-March. Clayton<sup>58</sup> found two maximum areas of sunspots each year for the period 1887-1938—one peak averaged between February and March and another averaged between September and October. Arctowski,<sup>59</sup> studying sunspot numbers for the period 1874-1913, found a peak averaged in September and the next averaged in February. Hess and Huystic<sup>60</sup> confirm the existence of regular seasonal variations in sunspot numbers. Reports on the International Geophysical Year 1957-58 indicate that in September 1947 the intense solar activity produced auroras that could be mapped on twenty-five nights. The great auroral storm of February 10-11, 1958 was one of the most spectacular in many years. In March 1958, auroras were seen on every night except one. The "Observed Sunspot Numbers"<sup>61</sup> for this period show one peak in September-October 1957 and another in February-March 1958. Perhaps the sun's crossing of the equator in September and March is a factor.

The similarity of the seasonal peaks of common cold incidence and sunspot activity indicate a relationship between these two

<sup>57</sup> A paper for the Petco Research Laboratory, New York, July 14, 1959.

<sup>58</sup> Clayton, *Solar Cycles*, Smithsonian Misc. Collection, 106:22 (1947).

<sup>59</sup> Arctowski, *Mem. Soci Spethoscopisiti*, 5 (1916), 98-99.

<sup>60</sup> Hess and Huystic, *Cosmic Radiation and Its Biological Effects*.

<sup>61</sup> *Predicted and Observed Numbers*, Department of Commerce, National Bureau of Standards, Boulder, Colorado.

phenomena; the former appears to be caused by the latter. The mechanism of the relationship appears to be the change in ionization of the atmosphere during increased sunspot activity. Sunspot activity produces X-rays that increase the ionization of the atmosphere. Freidman<sup>62</sup> and his associates at the Naval Research Laboratory discovered X-rays at times of solar flares in the lower D region of the ionosphere. His studies indicate that this X-radiation creates the increased ionization which leads to radio communication blackouts at times of intensive solar activity, while ultraviolet radiation does not. Soviet papers presented at the Fifth General Assembly of the Special Committee for the International Geophysical Year indicate the relative abundance of positive ions as a result of sunspot activity. Tchijevsky<sup>63</sup> conducted a series of studies on sunspot numbers and concluded that increased electrical activity around the sunspot maxima increases the positive ionization of the air. Apparently, there is greater leakage of charged particles to the earth's lower atmosphere than is generally suspected.

Positive ionization appears to have many adverse influences. A two-year study by a research team at Northeastern Hospital, Philadelphia, headed by Dr. Igho H. Kornbluch of the hospital and Dr. George M. Piersol, dean of the University of Pennsylvania Graduate School of Medicine, indicates that when the air is charged with positive ions, there is a notable increase of discomfort in the form of fatigue, dizziness, headache, asthma, and sinusitis. They reported that negative ions have a beneficial influence. Puck and Sagik<sup>64</sup> have shown that

viruses attach themselves to cells only when positive ions are present.

Physiologically, positive ionization affects the CO<sub>2</sub> absorption by the blood plasma and the acid-alkaline balance and impairs the O<sub>2</sub> intake and consumption. Professor John L. Worden<sup>65</sup>, of St. Bonaventure University, presents evidence that a positively ionized atmosphere decreases the ability of the blood plasma to combine with CO<sub>2</sub> and influences the acid-alkaline balance adversely. Haldene and Priestly, explaining the mechanism of the changes in rate of O<sub>2</sub> intake, show that the accumulation of CO<sub>2</sub> in the blood causes the respiratory center to be stimulated so that it sends impulses to the muscles of respiration, causing more rapid breathing and consequently more oxygen intake; on the other hand, decreased CO<sub>2</sub> in the blood plasma reduces O<sub>2</sub> intake. The acidity-alkalinity imbalance, as well as low CO<sub>2</sub> content, influences oxidation adversely. Gray<sup>66</sup> confirms this O<sub>2</sub> phenomenon. Peterson<sup>67</sup> shows that the pH changed and the CO<sub>2</sub> content was low two days before the onset of the common cold.

Adequate O<sub>2</sub> intake and unimpaired oxidation are essential for adequate heat production to avoid a thermal imbalance, the green light for possible common cold viruses to attack. In my paper, "Seasonal Cycles of the Common Cold and Their

<sup>65</sup> Worden, John L. Paper to the American Society for Experimental Biology.

<sup>66</sup> Gray, John S., "The Multiple Factor Theory of Respiratory Regulation," Project 386, Report 2: *Uncompensated Metabolic Disturbance of Acid-Base*, A.A.F. School of Aviation Medicine (December 14, 1945).

<sup>67</sup> Petersen, William F., *The Patient and the Weather*. Ann Arbor, Michigan: Edwards Brothers (1938)

<sup>62</sup> Odishaw, Hugh, "International Geophysical Year," *Science*, 128 (December 26, 1958), 3339.

<sup>63</sup> Dewey, Edwin A., and Dakin, Edward F., *Cycles, The Science of Prediction* (chapter 10). New York: Henry Holt (1954).

<sup>64</sup> Puck, H.P., and Sagik, A.C. (October 1954).

Relationship to Susceptibility,"<sup>68</sup> it is shown that the common cold viruses apparently strike or develop when a thermal imbalance develops. This imbalance lowers resistance and provides an environment for the common cold viruses to attack. Increased sunspot activity, by decreasing oxygen consumption, therefore, tends to increase susceptibility to the common cold viruses. This explains the similar peaks of incidence.

This relationship of the common cold to sunspot activity throws some light on the mysteries of the common cold. It may also indicate other interrelationships of phenomena in the upper atmosphere and terrestrial events; for example, the severe influenza epidemic in the fall of 1957 and the winter of 1958 coincided with the high 1957-58 sunspot activity.

Postscript, March 1969

(1) The Hong Kong flu epidemic of 1968-69 coincided with the high 1968-69 solar activity.

(2) Since the Apollo 7 and 9 astronauts broke out with colds during the high sunspot activity in October 1968 and in February 1969, my common cold research findings are being evaluated by the chief of the Astronauts' Clinic, NASA Manned Spacecraft Center.

---

<sup>68</sup> *Journal of Cycle Research*, 4:3 (July 1955),

# **The Rhythmic Cycles of Optimism and Pessimism**

Their origins; their effects upon stock market prices,  
money and credit, other leading indicators, and private spending;  
their challenge to the random-walk theory

(Original Version)

by L. Peter Cogan

*The Rhythmic Cycles  
of Optimism and Pessimism*

Introduction

THEIR ORIGINS; THEIR EFFECTS UPON STOCK MARKET PRICES,  
MONEY AND CREDIT, OTHER LEADING INDICATORS, AND PRIVATE  
SPENDING; THEIR CHALLENGE TO THE RANDOM-WALK THEORY

ALTHOUGH it is generally accepted that stock market prices reflect recurring alternations of optimism and pessimism to a considerable degree, most authorities are of the opinion that no clear evidence has been presented to indicate that stock market prices and/or optimism and pessimism tend to repeat themselves in cycles of approximately the same form and/or duration. Many attempts have been made to show a periodicity of business cycles, that is, a definite time interval from peaks to troughs, peaks to peaks, and troughs to troughs. None of these has stood up over a long period of time. The various lengths that have been presented have had the character of averages rather than of mechanical periodicity. On the other hand, current economic theory does not adequately explain the major and unexpected turning points in business and consumer sentiment.<sup>1</sup>

After thirty years of empirical observation and correlation—inspired by the late Joseph Snider, my professor in the course on business conditions

analysis at the Harvard Graduate School of Business Administration; by the pioneering studies of Arthur F. Burns, Wesley C. Mitchell, and Geoffrey H. Moore at the National Bureau of Economic Research; by Elmer C. Bratt's *Business Cycles and Forecasting* (1937); by Harold T. Davis' *The Analysis of Economic Time Series* (1941) for the Cowles Commission for Research in Economics; and by Edward R. Dewey's extensive comparative cycle research for the Foundation for the Study of Cycles—I have discovered rhythmic (that is, reasonably regular) cyclical patterns of optimism and pessimism on a yearly basis from 1870 to 1968.

*A Challenge to the  
Random-Walk Theory*

The aim of this monograph is to present these rhythmic cycles and to show that private borrowing, major business contractions, various leading indicators, and especially stock market prices (a very sensitive and volatile leading indicator of business activity) appear to follow these rhythmic cycles of optimism and pessimism to a remarkable

1. My paper, "Favorable and Unfavorable Factors in the Business Outlook and Their Influence on Business Confidence," November 26, 1937, at the Harvard Business School (see Appendix A), impelled me in search for new explanations for the changes in confidence.

[11]

degree in timing, sequence, and amplitude tendency. This phenomenon indicates that changes in direction and degree from optimism to pessimism, and vice versa, are not wholly chance or random behavior. It challenges the random-walk theory of stock market prices and implies that to a considerable extent stock market cycles and the persistent fluctuations of the United States economy have a psychological origin that is rhythmic.

*An Important Aid to Fiscal and Monetary Decision-Makers*

Knowledge of the rhythmic pattern of turning points in optimism and pessimism, especially after it has been refined to a monthly or even to a quarterly basis, could be an important aid to the proper application of fiscal action and monetary management. Economic policy decisions require the forecast of a number of economic variables,

but the most difficult and important variables to forecast are expenditures in the private sector of the economy, i.e., business investment in plant, equipment, and inventories, and consumer spending for durable goods. In both of these categories the direction of future expenditures is based upon both the ability to spend and the willingness to borrow, lend, and spend. The current and future willingness to borrow, lend and spend is in a large measure dependent upon the psychological factor of optimism or confidence. Consequently, a rhythmic cyclical pattern of optimism and pessimism that is nonrandom throws new and revealing light on turning-point theory, on forecasting problems, and on monetary and fiscal policies for economic growth and stability. Further economic-scientific research needs to be directed toward their causation in order to refine the rhythmic cycles to a quarterly or monthly basis and to validate projections of the rhythmic patterns into the future.

## I

*The Ideal Rhythmic Cycles of Optimism and Pessimism, 1870-1969*

*Chart I,A Shows the Ideal Timing*

Chart I,A presents the *ideal* timing of the cycles of optimism and pessimism from 1870 to 1968. The solid lines indicate the years when the cycles are in the "positive" phase; the dotted lines indicate the years when the cycles are in the "reverse" or "negative" phase.

*The "Positive" Phase*

An analysis of Chart I,A indicates that an "ideal" 17-year timing pattern for the positive phase (from late 1888 to the middle of 1950) appears to be as shown in Figure 1 where the long-term trend has been removed. For example, the 1915-32 pattern is indicated in Figure 1 (*The Ideal Timing Pattern in the Positive Phase*).

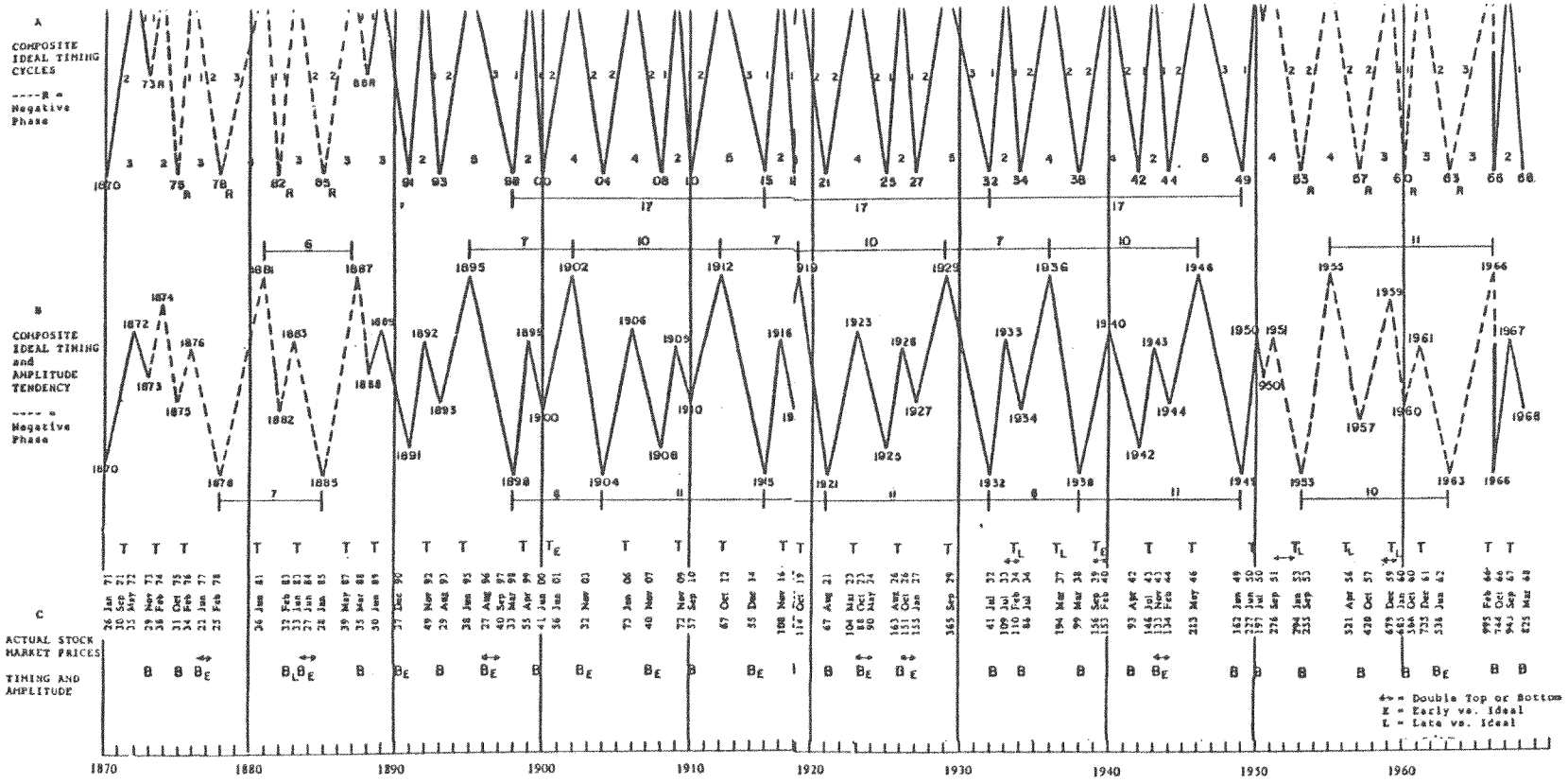
The ups and downs follow this pattern for 17 years and then repeat themselves (up approximately 1 year, down 1 year, up 2 years, down 2 years, up 2 years, down 2 years, up 1 year, down

1 year, up 2 years, and down 3 years). Each peak and each trough has a corresponding peak and trough approximately 17 years apart. Consequently, the 3-year decline from 1929 to 1932 repeats itself 17 years later, from 1946 to 1949, and 17 years earlier, from 1912 to 1915. Within an ideal 17-year period, as indicated in Figure 1 and Chart I,A the troughs tend to appear at intervals of approximately 2, 4, 4, 2, and 3 years apart; the peaks are 3, 4, 3, 3, and 4 years apart. Note the 4-year interval between the troughs of 1910-11, 1927-32, and 1944-49, each 17 years apart.

*The "Negative" or Reverse Phases*

The ideal timing pattern for late 1873 to early 1888 and for late 1950 to early 1966 (Chart I,A, dotted lines) appears in the reverse or negative phase with that of the late 1888 to the middle of the 1950 period. The reversals take place during late 1873 to the negative, early 1888 to the posi-





Source: 1871-1897 (Covles Index - All Stocks, Monthly Average)  
 1897-1929 (Dow Jones Industrials; 1897-1929, Monthly Average;  
 1930-1968; H.-L. Monthly).

Chart I. The Rhythmic Cycles of Optimism and Pessimism, 1870-1968, and Stock Market Prices, 1871-1968

[14]

[15]

©2009 COMAN

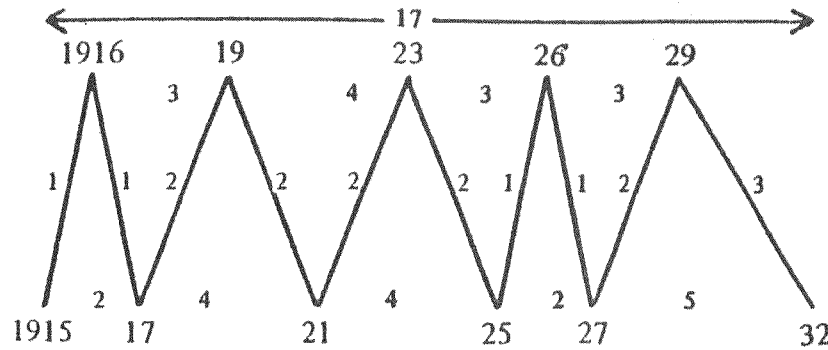


Figure 1. The Ideal Timing Pattern in the Positive Phase, 1915-32

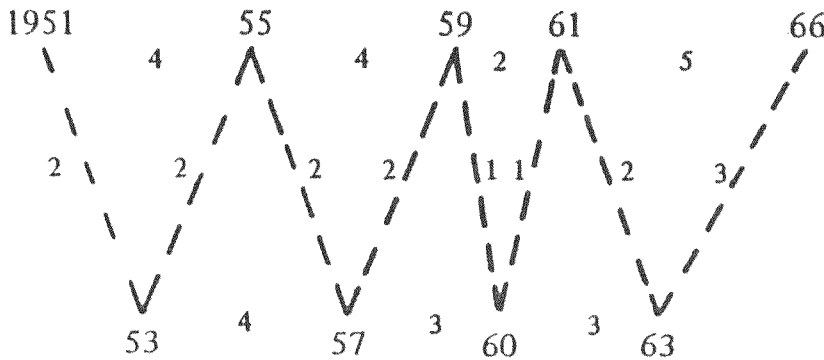


Figure 2. The Ideal Timing Pattern in the Negative Phase, 1951-66

tive, the middle of 1950 to the negative, and late 1966 back to the positive phase. For example, the reverse or negative pattern for 1951 to early 1966 is indicated in Figure 2 (*The Ideal Timing Pattern in the Negative Phase*).

Note that the 1951 peak is equivalent to the 1934 trough in reverse, 17 years earlier, i.e., a peak becomes a trough, and vice versa: 1953 as 1936, 1955 as 1938, 1957 as 1940, 1959 as 1942, 1960 as 1943, 1961 as 1944, 1963 as 1946, and early 1966 as 1949, but in reverse.

*The "Positive" Phases Again*

The ideal timing patterns for late 1870, 1871, 1872, and early 1873, and late 1966, 1967, and 1968, are in the positive phase, similar to the late 1888 to the middle 1950 period. Late 1966 is a trough in timing like 1932, 1967 is a peak like 1933, and 1968 is like 1934. Since the reversal takes place in 1966, the year 1966 is both a major peak and a trough year, and this could account for the 1966 credit crisis year.

*The 40-41-Month Cycle*

This ideal cycle pattern of optimism and pessimism explains the so-called "40-41-month average" stock market cycle. For example, during the 17 years from 1915 to 1932 there were five cycles for an average of 3.4 years (or 40.8 months) each; however, as indicated above, the ideal cycle ranged from approximately 2 years to 5 years. In other words, there is no 40-41 month cycle; 40-41 months (or 3.4 years) are merely the averages of the 2- to 5-year cycles over a period of 17 years (as shown in Figure 1).

*The "Decennial Pattern"*

This ideal cyclical discovery also explains the failures and coincidental successes of the "decennial pattern" theory of stock prices discovered by Edgar Lawrence Smith and followed by some stock market analysts. When the decennial pattern has been in phase with the rhythmic cycles, it has been successful, but when it has been out of phase, as in 1949, it has failed.

*Chart I,B Shows the Ideal Timing and Amplitude Tendency*

Chart I,B shows the ideal timing and amplitude tendency of the rhythmic cycles of optimism and pessimism. An analysis of Chart I,B indicates that in the 1888-1950 period the ideal major declines start in 1895, 1912, 1929, and 1946. Also, the ideal large declines start in 1902, 1919, and 1936. At the other extreme, the ideal minor declines start in 1892, 1909, 1926, and 1943. Somewhat more important are the ideal declines that start in 1899, 1916, 1933, and 1967 and the declines from 1889, 1906, 1923, and 1940.

*Major Turning Points at 7- and 10- or 6- and 11-Year Intervals*

The major ideal peaks of optimism in the positive phase tend to appear at alternating intervals of 7 and 10 years, i.e., 1895-1902 (7 years), 1902-12 (10 years), 1912-19 (7 years), 1919-29 (10 years), 1929-36 (7 years), and 1936-46 (10 years).

The major ideal troughs in the positive phase are 6 and 11 years apart, i.e., 1915-21 (6 years),

## THE RHYTHMIC CYCLES OF OPTIMISM AND PESSIMISM

1921-32 (11 years), 1932-38 (6 years), and 1938-49 (11 years).

In the reverse or negative phase the major ideal peaks are 6 and 11 years apart and the major ideal troughs are 7 and 10 years apart, i.e., peaks 1881-87 (6 years) and 1935-66 (11 years); troughs 1878-85 (7 years) and 1933-63 (10 years).

The interval between three major peaks or three major troughs, as shown in the positive phase, is 17 years: 10 plus 7 (17 years), 11 plus 6 (17 years).

#### The Timing of the Next Phase Reversal

Recent research findings, based upon the period prior to late 1870 (not shown in the charts), indicate that the ideal rhythmic cycle should change from the positive phase to the negative phase near the beginning of 1969. Consequently, this should result in an important stock market decline in 1969 and also a decline, first, in the "leading indicators" and then in the rate of growth of the "concurrent" and "lagging" indicators of business activity.

#### The 1/4 and 1/12 of 17-Year Ideal Rhythmic Cycles in Stock Market Prices

In addition to the ideal cycles that average 1/3 of 17 years (3.4 years, or 40.8 months), as shown in Charts I,A and I,B, there are also strong indications since 1949 (not shown on the charts) of ideal average cycles of 1/4 of 17 years (4 1/4 years, or 51 months) and, since 1966 (not shown on the charts), of ideal average cycles of 1/12 of 17 years (1 5/12 years, or 17 months).

The 1/4 of 17-year cycles (51 months) for the 17-year period from 1949 to 1966 have ideal major bottoms in the middle of 1949, late in 1953, late in 1957, in the middle of 1962, and late in 1966. The ideal bottom of the 1/3 of 17-year cycles is in early 1963. This single conflict may explain the double bottom in 1962.

The 1/12 of 17-year cycles (17 months) from 1966 to 1968 have an ideal top early in 1966, a bottom late in 1966, a top near the middle of 1967, a bottom early in 1968, and a top very late in 1968. An ideal bottom is indicated after the middle of 1969.

2

### A Comparison of Actual Stock Prices, 1871-1968, With the Ideal Rhythmic Timing Patterns of Optimism and Pessimism

#### The Timing of Actual Stock Price Tops and Bottoms

Chart I,C shows the actual tops and bottoms of stock prices (1871-1968). The letter *T* indicates the year of the top and *B* the year of the actual bottom; *E* indicates that the actual top or bottom comes earlier than the ideal date; and *L* indicates that it comes later. This chart identifies the month of the top and the bottom, and the price.

#### The Actual Versus the Ideal Tops and Bottoms

Chart II,A is a summary of the actual versus the ideal tops and bottoms in the positive phases.

1. Out of a total of 21 tops, 2 actual tops are earlier than the ideal, 2 are later, and 17 are on schedule. Of the early tops, one is in the first part of the prior year (June 1901 versus the ideal

1902) and one is in the latter part of the prior year (September 1939 versus the ideal 1940). Both late tops are in the early part of the following year (February 1934 versus the ideal 1933 and March 1937 versus the ideal 1936).

2. Out of a total of 20 bottoms, 8 are early, none are late, and 12 are on schedule. However, of the 8 early bottoms, 6 are in October-December of the prior year, but 2—1923 and 1896—are two years early.

3. Many of the actual major tops seem to come in the latter part of the year—1919, 1929, 1936 (March 1937), and 1946. Many actual major bottoms seem to come in the early part of the year, such as in 1938, 1942, and 1949. This tendency may help to explain the 6 bottoms that come 1 to 3 months prior to the ideal bottom year and tends to indicate the need for further research to determine the exact month or quarter of the ideal top and bottom; the ideal pattern that is shown is an approximate one since it indicates the cycles only on a yearly basis.

1171

Chart II.B. Actual Versus Ideal Tops and Bottoms in Stock Market Prices—Negative Phase

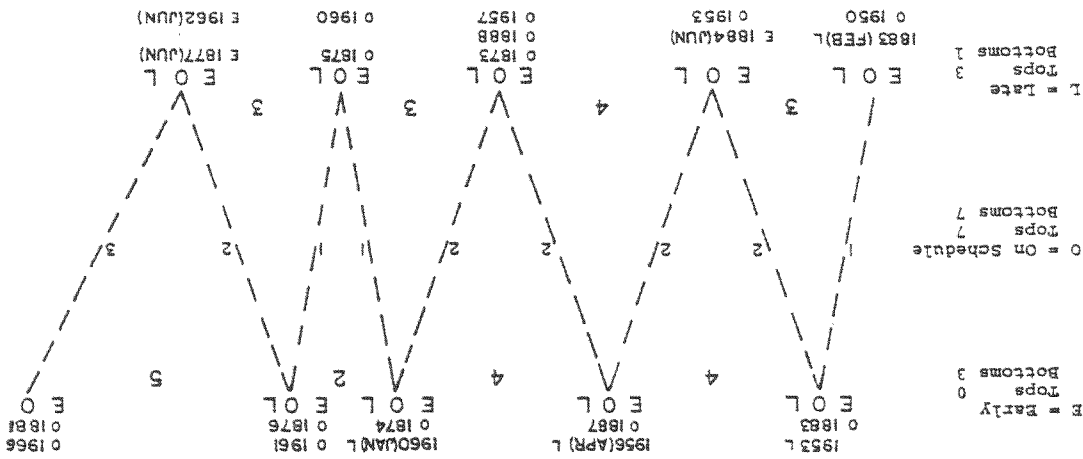
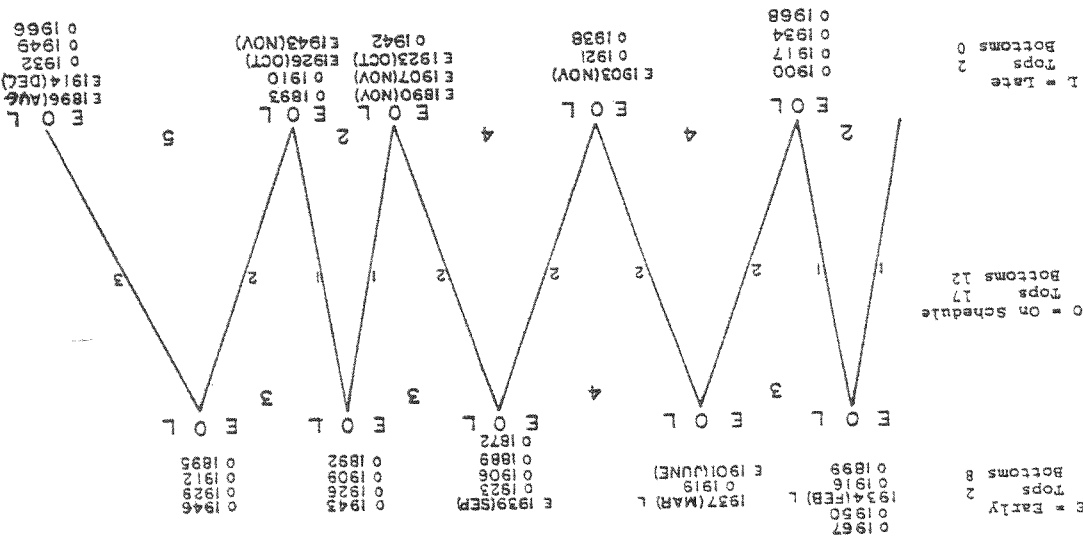


Chart II.A. Actual Versus Ideal Tops and Bottoms in Stock Market Prices—Positive Phase



1021

Chart II,B is a summary of the actual versus the ideal tops and bottoms in the negative phases.

1. Out of a total of 10 tops, 3 are late, none are early, and 7 are on schedule. Two late tops occur in the early part of the following year (April 1956 versus the ideal 1955 and January 1960 versus the ideal 1959). One double-tops in 1951-53.

2. Out of 11 bottoms, 7 are on schedule, 1 is late, and 3 are early. The 3 early bottoms are all in the prior June (1884, 1887, and 1962). In the 1951-66 period the on-schedule bottoms tend to come late in the year (1953, 1957, and 1960).

In the period 1871-1968 there are 62 actual turning points; 43 are on schedule versus the ideal, 13 are early, and only 6 are late; out of 31 tops, 24 are on schedule.

These figures demonstrate a relatively high degree of correlation, especially when it is recognized that no stock market index can be a perfect reflection of the ideal rhythmic cycles of optimism and pessimism. Moreover, it is possible that there could be a closer correlation if we knew the exact monthly or quarterly timing of the ideal rhythmic cycles.

*Major Turning Points at 7- and 10- and 6- and 11-Year Intervals*

The actual major tops in the long positive phase appear at alternating intervals of approximately 7 and 10 years; the interval between the 3 major tops is 17 years.

1895-June 1901	6 1/2 years (approx.)
June 1901-1912	10 1/2 years (approx.)

1912-1919	7 years
1919-1929	10 years
1929-March 1937	7 1/4 years (approx.)
March 1937-1946	9 3/4 years (approx.)

Actual major bottoms in the long positive phase appear at alternating intervals of approximately 6 and 11 years (except 1896-1903); the interval between the 3 major bottoms is 17 years.

1896-November 1903	7 years (approx.)
November 1903- December 1914	11 years
December 1914-1921	6 years (approx.)
1921-1932	11 years
1932-1938	6 years
1938-1949	11 years

In the negative phase the major tops are 1881-87 (6 years) and April 1956-66 (approximately 10 instead of the ideal 11 years); the major bottoms are 1877-84 (approximately 7 1/2 years) and 1933-62 (approximately 9 plus versus the ideal 10 years). In the short negative phases the regularity of the intervals between the stock market major tops and bottoms is inconclusive.

During the entire 1871-1968 period the widest deviation appears in the 1896 bottom versus the ideal of 1898. The ideal 3-year drop from optimism to pessimism from 1895 to 1898 produced a business crisis that started in 1895, but apparently the greatly increased production of gold reversed the trend in late 1896. This would indicate that strong monetary factors are able to modify the ideal timing and amplitude cycle.

*A Comparison of Actual Stock Prices With the Ideal Timing Amplitude Pattern*

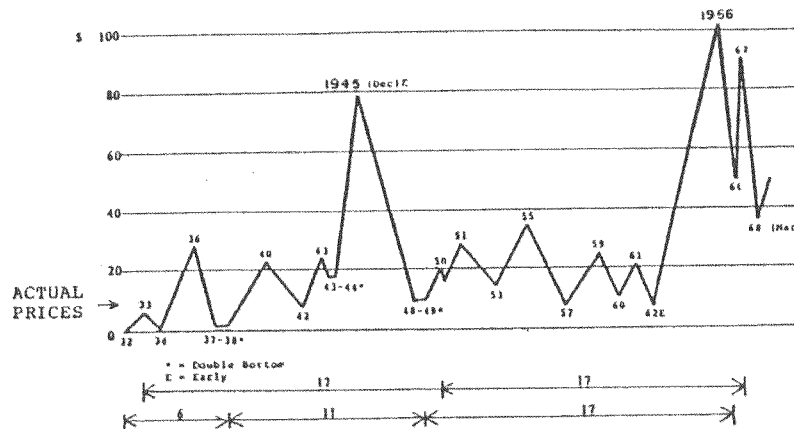
A comparison of Charts I,B and I,C shows that the actual amplitude of major declines in 1895, 1912, and 1946 in the positive phase follows the ideal pattern. However, the actual 1929-32 drop is much larger than anticipated. In the negative phase the actual large advances up to 1881 and up to 1966 follow the ideal pattern.

Also, the actual declines follow the ideal declines from 1902, 1919, and 1936 reasonably well, as do the advances to 1887 and to 1955. At the other extreme, the actual declines are minor, as indicated by the ideal patterns in 1909, 1926, and 1943, but are larger than expected in 1892. At the next level there are moderate declines in 1899, 1933, 1950, and 1967, but the drop from 1916 to 1917 is larger than the ideal pattern.

Until we find another possible cause, we must attempt to explain the larger than the ideal declines in 1892, 1916, and 1929 in terms of prior excess stock market speculation and various fiscal and monetary factors.

It is well accepted that the amplitude of business and stock market cycles is, to a large extent, influenced by monetary and fiscal policies. However, it is interesting to note the influence of multiples of 17 years. The extreme boom high of 1929, in the positive phase, is 51 years (3 times 17) from the major depression bottom of 1878 in the negative phase, and the extreme bottom of 1932, in the positive phase, is 51 years after the major top of 1881 in the negative phase. Moreover, perhaps it is no coincidence that the 1967-68 gold crisis was 34 years (2 times 17) after the 1933-34 gold crisis.

*A Comparison of the Actual Prices of a Cyclical Stock, TWA, With the Ideal Time-Amplitude Pattern of Optimism and Pessimism*



An inspection of Chart III (Trans-World Airlines, Inc.) shows how a so-called cyclical stock follows the ideal pattern of optimism and pessimism (Chart 1,B) from 1932 to 1968, years which include the positive and negative phases of the rhythmic cyclical patterns.

*The Actual Versus the Ideal Timing of Tops and Bottoms*

In the positive phase, 1932, 1933, 1934, and 1936 are on schedule; there is a double bottom in late 1937 and in early 1938 versus the ideal 1938; 1940, 1942, and 1943 are on schedule; there is a double bottom late in 1943 and in early 1944 versus the ideal 1944; the top comes in late 1945 instead of in the ideal 1946; a double bottom comes in late 1948 and in early 1949 versus the ideal 1949; there is a top in early 1950 and the beginning of a decline in 1950 on schedule.

In the negative phase from late 1950 to early

1966 the actual follows the ideal pattern every year except in 1963, when the actual bottom came in 1962 as a double bottom in June and October. In this so-called cyclical stock we see clearly the tops in 1951 and 1955, which are not so clearly apparent in the Dow Jones Industrial Index.<sup>1</sup> In 1966 the stock tops early in the year on schedule and drops into October 1968, when the ideal pattern reverses into the positive phase for late 1966, 1967 and 1968. TWA makes a bottom in late 1967 top in 1967, and a bottom in 1968 (March) on schedule.

*The Actual Versus the Ideal Timing-Amplitude Tendency*

The amplitude of the actual prices follows the ideal pattern rather closely in both the positive and negative phases. There are major bottoms in

1. See Figure 3.

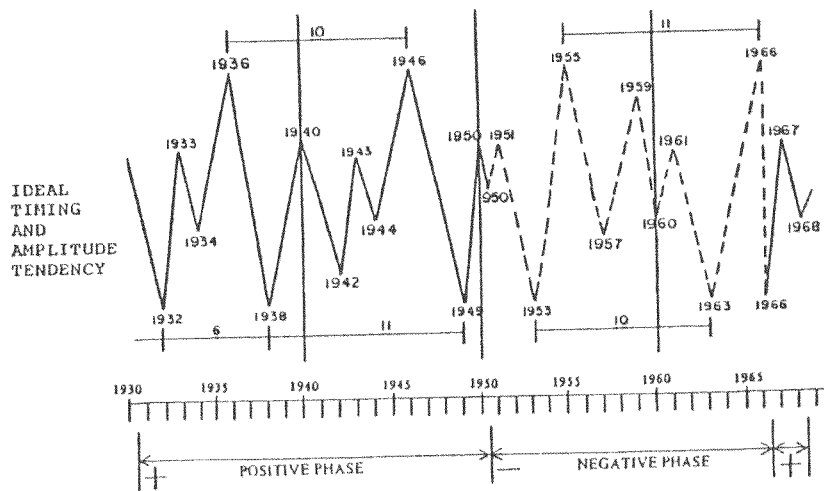
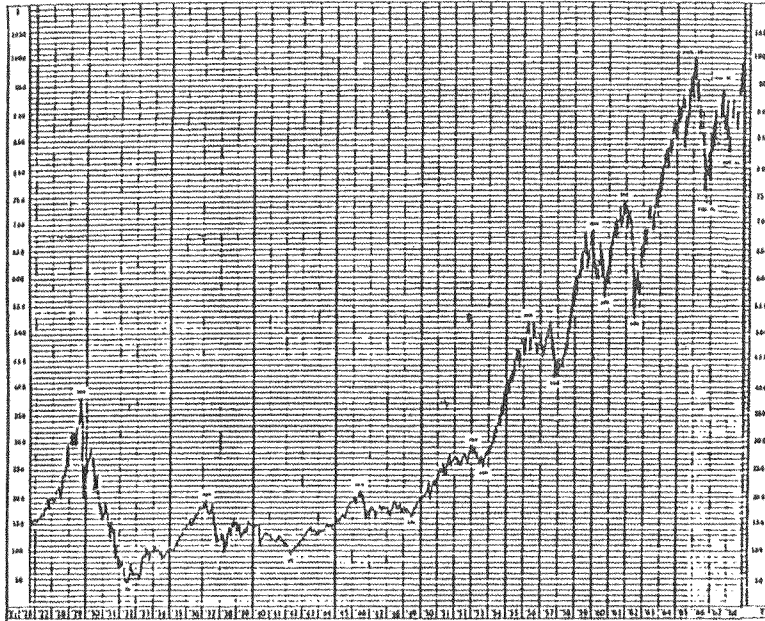


Chart III. Trans-World Airlines, 1932-68, Versus the Ideal Pattern

DOW-JONES INDUSTRIAL AVERAGE



DOW-JONES RAIL AVERAGE

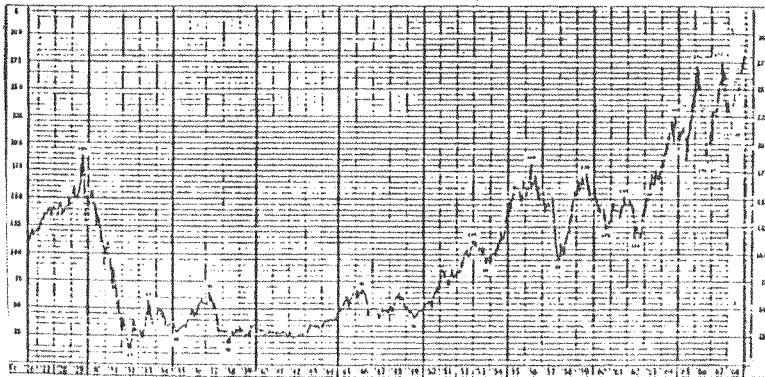


Figure 3.

[26]

## THE RHYTHMIC CYCLES OF OPTIMISM AND PESSIMISM

1932, 1938, November 1948 versus the ideal 1949, 1953, and 1962 versus the ideal 1963, and major tops in 1936, December 1945 versus the ideal 1946, 1955, and 1966.

In the positive phase the major bottoms are approximately 6 and 11 years apart (1932-1938-November 1948); the major tops are approximately 10 years apart (1936-December 1945), as in the ideal pattern. In the negative phase, the major top of 1955 is approximately 6 years after the positive phase bottom of November 1948 and 11 years before the early 1966 top, as in the ideal pattern. The major bottom of 1953 is approximately 7 years after the positive top of December 1945, but 9 years before 1962, instead of the ideal 10 years, since the 1962 bottom is early

versus the ideal 1963; however, this was a major TWA bottom.

*Rhythmic Investor Psychology  
a Major Factor*

On the whole, it appears that the ideal rhythmic cycles reflect changes in optimism and pessimism as they affect cyclical stocks. Consequently, a cyclical stock, such as TWA, follows the ideal pattern more closely than mixed averages, such as the Dow, Standard and Poor's, etc. The high degree of conformity of the actual TWA price pattern to the ideal pattern seems to indicate rather strongly that stock price cycles are not random events. It also confirms the premise that investor psychology is a major factor in the cyclical motion of stock prices.

**WWW.FOREX-WAREZ.COM**  
**ANDREYBBRY@GMAIL.COM SKYPE: ANDREYBBRY**

*The Random-Walk Theory of Stock Market Prices  
and the Rhythmic Cycles of Optimism and Pessimism*

The close correlation of both aggregate stock market prices and TWA stock prices with the rhythmic cycles of optimism and pessimism seems to refute the random-walk theory of stock price changes. This theory, first proposed by Bachelier,<sup>1</sup> implies that speculative prices fluctuate randomly about their intrinsic values and that historical data about the price of a stock or stock prices are of little help in forecasting future prices.

The random-walk hypothesis assumes an approximate Brownian motion, according to Osborne,<sup>1</sup> and states that the next move is independent of all past moves and that, therefore, knowledge of past price changes yields no significant information about future price changes. Roberts<sup>1</sup> infers that seemingly regular patterns are illusory and are the result of pure chance. However, Alexander<sup>1</sup> concludes that there are "trends" in stock market prices if the "move" is taken as the unit rather than "time." Granger and Morgenstern<sup>1</sup> find, through spectral analysis, that

while the simple random-walk model explains rather well the short-run movements of the stock prices, the model does not adequately explain the very important long-run movements. In fact, they find some evidence of a forty-month cycle, but only inconclusively, as one would expect from my prior comments on this cycle. The impression that one gets from the Cootner<sup>1</sup> selection of essays is that while the simple random-walk model does not fully describe the movements of stock prices, in modified form it is considered to be a reasonable approximation.

The rhythmic cycles of optimism and pessimism, at this stage, offer no theory or pattern for short-run movements, but they have produced empirical evidence that would seem to refute the random-walk hypothesis for long-run movements of stock prices.

1. Cootner, Paul H. (ed). *The Random Character of Stock Market Prices*. Cambridge, Massachusetts: The M.I.T. Press (1964).

[28]

*The Money Supply, the Major Business  
Contractions, and the Ideal Rhythmic  
Cycles of Optimism and Pessimism*

Discussing money and business cycles, Friedman and Schwartz<sup>1</sup> state: "The outstanding cyclical fact about the stock of money is that it has tended to rise during both cyclical expansions and cyclical contractions . . . . The only major exceptions since 1867 to the tendency of the money stock to rise during both cyclical expansions and cyclical contractions occurred in the years listed in the following tabulation, which gives also the percentage decline during each exception.

Years of Exception	Percentage Decline
1873-79	4.9
1892-94	5.8
1907-08	3.7
1920-21	5.1
1929-33	35.2
1937-38	2.4

1. "Money and Business Cycles," *The Review of Economics and Statistics* (February 1963).

"In addition, there were two minor exceptions since the end of World War II:

1948-49	1.4
1959-60	1.1

The major exceptions clearly did not fall in a random subset of years. Each corresponds with an economic contraction that was major as judged by the other indicators; in the period covered there was no other economic contraction more severe than any in the list."

Friedman and Schwartz therefore conclude that the decline in the money stock was a major cause of the contraction in business activity in the periods listed.

In reply to this and subsequent papers by the Chicago School, Davis<sup>1</sup> states: "There is a real question as to whether anything can be inferred

2. Davis, R. G. "The Role of the Money Supply in Business Cycles," *Federal Reserve Bank of New York Monthly Review* (April 1968).

[29]



THE RHYTHMIC CYCLES OF OPTIMISM AND PESSIMISM

from the historical record about the influence of money on business if, as is argued in the next section, there is an important reverse influence exerted by the business cycle on the monetary cycle itself . . . The fact that the business cycle itself has an important role in determining the course of the monetary cycle seriously undermines the argument that the timing relationships of monetary cycles and business cycles point to a dominant influence of money on business. By the same token, ample room is left for the possibility that many other factors, such as fiscal policy, fluctuations in investment demand, including those related to technology, fluctuations in exports, and replacement cycles in consumer goods, may also exert independent influences on the course of business activity."

Rhythmic Cycles  
the Missing Links

I suggest that the rhythmic cycles of optimism and pessimism are the "missing links" and were an important factor in the business contraction periods listed by Friedman and Schwartz. Every money and business contraction listed by Friedman and Schwartz and every advance from those declines were triggered by a rhythmic cycle change from optimism toward pessimism, and vice versa, as indicated on Chart I,B (Ideal Timing and Amplitude Cycles), as follows:

Years of Exception	Years of Ideal Cycle Decline
1873-79	1872-73
	1874-75
	1876-78
1892-94	1892-93
1907-08	1906-08

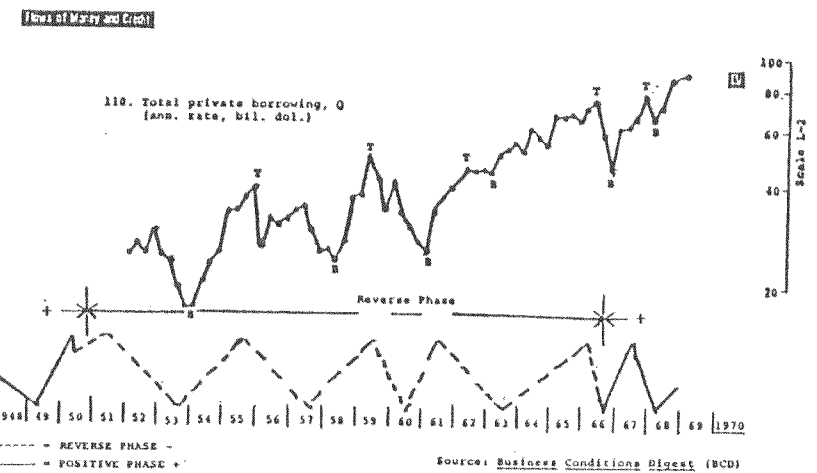
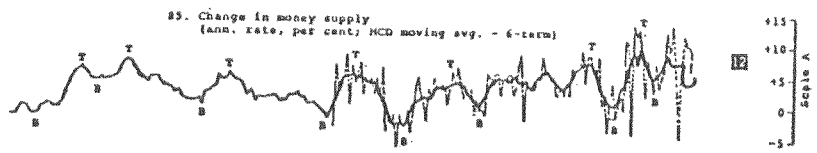
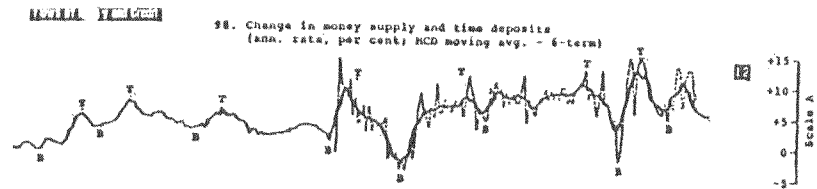
1920-21	1919-21
1929-33	1929-32
1937-38	1936-38
1948-49	1946-49
1959-60	1959-60

This empirical evidence would tend to support the proposition that while the money supply has an influence on business and business on money supply, the rhythmic cycles of optimism and pessimism influence speculation and business expectations; "lack of confidence" adversely affects the willingness to lend, borrow (Chart IV, *Ideal Cycles vs. Money and Credit*), and spend on business investment and consumer durables, can lead to panics and runs on banks, and can precipitate major stock price declines. It therefore supports the "Keynes and Simons interpretations of 1929-33: they both argued that it is a collapse of confidence which sets off a demand for liquidity, that this demand cannot be met but the attempts to meet it force liquidation, and that this liquidation includes bank loans with a resultant decline in the quantity of money . . . both Simons and Keynes emphasized the state of business expectations and the desire for liquidity."<sup>3</sup>

Moreover, the remarkable time correlations of money, business, and the rhythmic cycles during the years listed by Friedman and Schwartz are a further confirmation of the reality of the rhythmic cycles of optimism and pessimism.

Furthermore, this new theory is consistent with the findings of Anderson and Jordan<sup>4</sup> that a change in Z is explained by factors other than monetary and fiscal forces, where Z is a variable

3. Davis, J. Roanick, *American Economic Review* (June 1968).  
 4. Anderson, Leonall C., and Jordan, Jerry L., "Monetary and Fiscal Actions: A Test of Their Relative Importance in Economic Stabilization," *Federal Reserve Bank of St. Louis Review* (November 1968).



TIMING OF IDEAL CYCLES (yearly basis)

Chart IV. Ideal Cycles Versus Money and Credit

©2009 GOWAN

summarizing all "other" forces that influence total spending. Their major conclusions are that fiscal actions have little influence upon total spending unless the deficit is financed by an increased money supply, but that changes in the money supply are a major influence. However, since it

has already been shown that changes in the cycles of optimism and pessimism influence demand-induced changes in the money supply, the findings of Anderson and Jordan furnish additional evidence for the large role of the rhythmic cycles of optimism and pessimism on private spending.

6

*Some Leading Business Indicators  
and the Ideal Rhythmic Pattern*

The sensitive "Leading Business Indicators" (1948-68), as published in the Department of Commerce *Business Condition Digest* (formerly *Business Cycle Developments*), seem to correlate with the ideal rhythmic pattern in the positive and the negative phases to a degree that cannot be explained by chance or random behavior. The following BCD volatile series are suggested for comparison:

Series 1. *Average Workweek, Production Workers, Manufacturing* (hours). (Chart V.)

In the positive phase, 1949 is a bottom and on schedule versus the ideal cycle; there is a rise into the middle of 1950; and the start of a decline on schedule.

In the reverse phase, there is a rise from the middle of 1950 to a top in 1951 on schedule; a bottom very early in 1954 versus the ideal 1953; a top in 1955 on schedule; a bottom very early in 1958 versus the ideal 1957; a top in 1959 and a bottom in 1960, both on schedule; a top in early 1962 versus the ideal 1961; and a bottom in late 1963 and a top in early 1966, both on schedule.

In the positive phase, there is a bottom very early in 1967 versus the ideal late 1966; and a top in 1967 and a bottom in early 1968, both on schedule. The major discrepancy is in 1952.

Series 6. *New Orders, Durable Goods Industries* (bil. dol.). (Chart V.)

In the positive phase, 1949 is a bottom on schedule versus the ideal cycle; there is a rise into the third quarter of 1950 and the beginning of a decline on schedule.

In the reverse phase, there is a rise to a top in 1951 on schedule; a bottom in September 1953 and a top in December 1953, both on schedule; a bottom in January 1958 versus the 1957 ideal; a top in 1959 on schedule; a bottom in January 1961 versus the ideal 1960; a top in early 1962 versus the ideal 1961; a bottom in 1962 versus the ideal 1963; and a top in late 1966 versus the ideal early 1966.

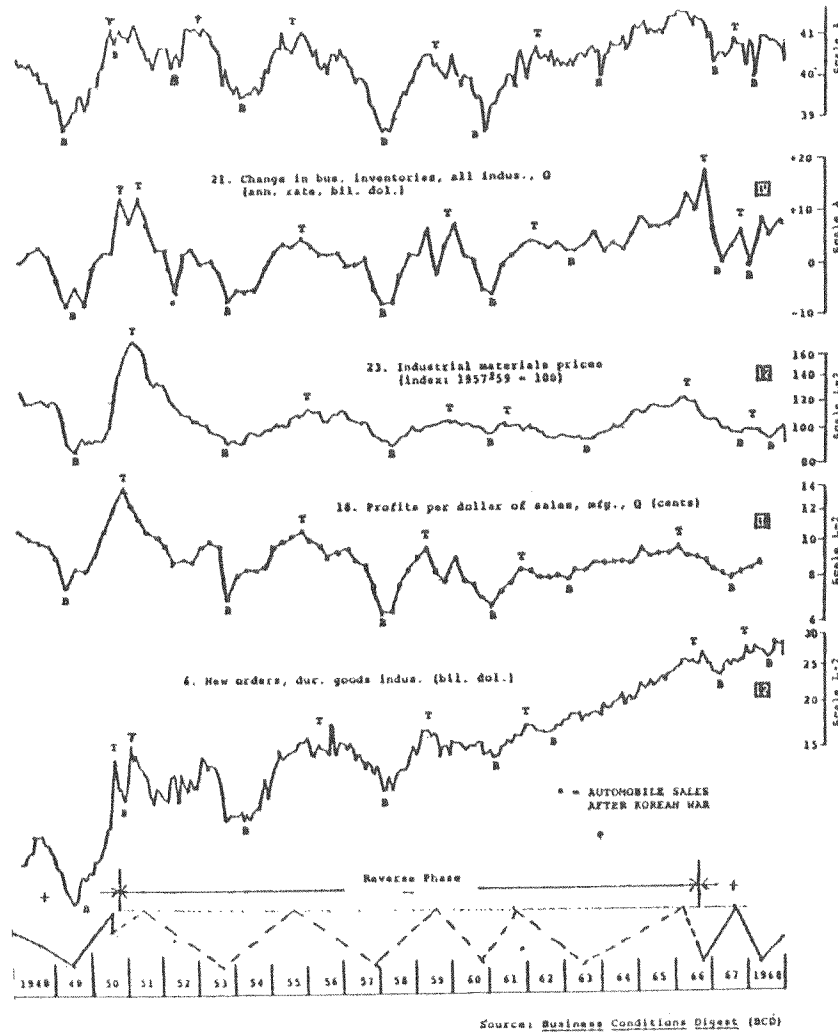
In the positive phase, there is a bottom in early 1967 versus the ideal late 1966; a top in January 1968 versus the ideal 1967; and a bottom in 1968 on schedule.

[33]

[32]

THE RHYTHMIC CYCLES OF OPTIMISM AND PESSIMISM

©2009 GOWAN



TIMING OF IDEAL CYCLES (yearly basis)

Chart V. Ideal Cycles Versus the Leading Indicators

[34]

Series 21 (now Series 245), *Change in Business Inventories, All Industries, Q.* (ann. rate bil. dol.). (Chart V.)

In the positive phase, there is a bottom in 1949 on schedule; a rise into 1950; and the beginning of a decline on schedule.

In the negative phase, there is a top in 1951, a bottom in 1953, and a top in 1955, all on schedule; a bottom very early in 1958 versus the ideal 1957; a double top in 1959 and early 1960 (because of the steel strike) versus the ideal 1959; a bottom very early in 1961 versus the ideal 1960; a top in the first quarter of 1962 versus the ideal 1961; a bottom in 1963 on schedule; and a top in late 1966 versus the ideal early 1966.

In the positive phase, there is a bottom in the second quarter of 1967 versus the ideal late 1966; and a top in 1967 and a bottom in the first quarter of 1968, both on schedule.

Series 23, *Industrial Materials Prices* (Index: 1957-59=100). (Chart V.)

In the positive phase, there is a bottom in 1949 on schedule; a slight rise into 1950; and a plateau through early 1950.

In the negative phase, there is a rise to a top in 1951 on schedule; a bottom in February 1954 versus the ideal 1963; a top in December 1955 on schedule; a bottom in April 1958 versus the ideal 1957; and a top in 1959, a bottom in 1960, a top in 1961, a bottom in 1963, and a top in early 1966, all on schedule.

In the positive phase, the bottom is in 1967 versus the ideal late 1966; a slight rise to a top in both 1967 and early 1968; and a bottom in 1968, as with the ideal.

Series 18, *Profits per Dollar of Sales, Manufacturing, Q.* (cents). (Chart V.)

In the positive phase, there is a bottom in 1949

and a sharp rise into 1950 on schedule; however there is no start of a decline in 1950.

In the reverse phase, there is a sharp rise to a peak in the fourth quarter of 1950 versus the idea 1951; a bottom in 1953 and a top in 1955, both on schedule; a bottom in the first quarter of 1966: versus the ideal 1960; a top in 1961, a bottom in 1963, and a top in the first quarter of 1966, all on schedule.

In the positive phase, there is a bottom in 1967 versus the ideal late 1966, and a continuation of the rise without a dip from 1967 into 1968. However, in Series 16, *Corporate Profits After Taxes, Q.* (ann. rate, bil. dol.), there is a bottom in the first quarter of 1967 versus the ideal late 1966, and a top in the fourth quarter of 1967 and a bottom in the first quarter of 1968, both on schedule.

In Series 1, 21, 18, and 6, the 1952-53 distortion is not forecast by the ideal cycle. It was caused by the sharp drop in automobile sales from 1950 to 1952 during the Korean War and then by the sharp rise from 1952 to 1953 (see Series 234, *Automobile Sales*, and Series 113, *Change in Consumer Installment Debt*).

Money and Credit  
Reflect Rhythmic Cycles

Special attention is again directed to Series 85, *Change in Money Supply*, Series 98, *Change in Money Supply and Time Deposits*, and Series 110, *Total Private Borrowing* (Chart IV), in view of the many recent articles on the role of the money supply in business cycles. These series follow the ideal rhythmic pattern to such a high degree that it would seem that the ideal rhythmic cycles of optimism and pessimism influenced the timing of

[35]

cycles in private borrowing and in the demand-induced money supply; the turning points in money are generally earlier because of the monetary moderating action by the Federal Reserve. While "changes" in money supply had an influence upon business and business upon the demand-induced money supply, it is seen here that the rhythmic cycles of optimism and pessimism had an important influence upon expectations and upon the timing and amplitude of private borrowing and business. On the other hand, it would appear that fiscal and monetary policy influenced the amplitude and timing of the money supply and then the business cycles in varying degrees, depending upon the action taken and the confidence, liquidity, and ingenuity of the lenders, borrowers, and spenders. Perhaps prior knowledge of the ideal rhythmic cycles could have avoided the unnecessary sharp changes in monetary and fiscal action during 1966, 1967, and 1968.

*What Happens When Rhythmic  
Cycles Reinforce or Oppose  
Fiscal and Monetary Action*

In view of the degree of correlation between the leading business indicators and the ideal cycles, it is suggested that the long rhythmic cycle of optimism from 1963 to 1966 was a major factor in the 1963-66 boom, in addition to the important tax measures and monetary expansion. Moreover, the rise of the ideal cycle of optimism from its early 1968 bottom explains the 1968 advance in stock prices and the "unexpected" sustained gain in consumer spending and, especially, in business lending, borrowing, and spending through the spring of 1969, despite the influence of the tax surcharge, high interest rates, and a tight monetary, fiscal, and debt management policy.

[36]

It seems that we must conclude that the business cycle still exists in the private sector and that stock prices and both consumer and businessmen's expectations, spending, borrowing, and bank lending are influenced by changes in optimism and pessimism that are rhythmic in nature.

In fact, at the same time that optimism and pessimism influence stock prices, major stock price changes, as an early indicator and through realized and "paper" profits and losses, in turn influence and reinforce expectations, spending, borrowing, and lending both upward and downward.

*Business Depressions, Emotional  
Depressions, and the Rhythmic  
Cycles of Pessimism*

It is also interesting to note that psychiatric research indicates a correlation between business depressions and the peak periods of emotional depressions and the rhythmic cycles of pessimism. Brenner<sup>1</sup> finds that fluctuations in mental hospital admissions show strong inverse correlations with fluctuations in the employment index in New York State over the period 1910 to 1960. Therefore, since it has been shown that both employment and economic activity show a strong positive relationship to the ideal rhythmic cycles of pessimism, we have evidence here for the speculation that the rhythmic cycles of pessimism are related to both emotional and business depressions.

Consequently, more knowledge about the rhythmic cycles of optimism and pessimism should improve the proficiency in economic forecasting.

1. Brenner, M. H., "Economic Change and Mental Hospitalization: New York State, 1910-1960," *Social Psychiatry*, 2:4 (1967).

which is so important for any "New Economics." Moreover, this knowledge would be valuable for longer forecasts of 3 to 5 years; most present methods are not designed for this objective. While

structural and institutional changes in the United States economy seem to have made the business cycle more stable since 1946, there is no certainty of a continuation of stability in the future.

[37]

### The Possible Origins of the Rhythmic Cyclical Patterns

#### The Overlapping Rhythmic Cycles and the Timing of Reversals

The ideal composite timing and amplitude cycles (Chart I,B) seem to be a synthesis of overlapping rhythmic cycles that produce the rise and decline in terms of time and amplitude and trigger the turning points. Chart VI,A,B (*Overlapping Rhythmic Cycles and Timing of Reversals*) illustrates the ten overlapping rhythmic cycles, each with tops and bottoms 17 years apart. The letter R on Chart VI indicates when the cycle is in the reverse or negative phase, shown reversed as dotted lines on Chart I,A,B. Chart VI,A, lines 1-5, show, on a yearly basis, the timing, duration, and amplitude tendency of declines in the positive phase and advances in the R or negative phase. Chart VI,B, lines 1-5, show, on a yearly basis, the timing, duration, and amplitude tendency of advances in the positive phase and declines in the R or negative phase.

[38]

#### Declines in the Positive Phases and Advances in the Negative Phases

Chart VI,A, line 1, in the positive phase, shows on a yearly basis the ideal declines of one year from 1899 to 1900, 1916 to 1917, 1933 to 1934, and 1967 to 1968. Since 1950 is a reversal year, it is both a top and a bottom. In the negative R phase, line A1, 1882 to 1883 becomes an advance; likewise, 1950 to 1951 in the R phase is an advance.

A2, in the positive phase, shows the major ideal declines of three years from 1895 to 1898, 1912 to 1915, 1929 to 1932, and 1946 to 1949. In the negative R phase, 1878 to 1881 and 1963 to 1966 become major ideal advances.

A3, in the positive phase, shows the ideal declines of two years from 1889 to 1891, 1906 to 1908, 1923 to 1925, and 1940 to 1942. In the positive phase, 1872 to late 1873 is a decline. In the R phase, 1874 becomes a top after a rise from

1873, the reversal year; likewise, in the R phase, 1957 to 1959 becomes an advance.

A4, in the positive phase, shows the major ideal declines of two years from 1902 to 1904, 1919 to 1921, and 1936 to 1938. In the R phase, 1885 to 1887 and 1953 to 1955 become major ideal advances.

A5, in the positive phase, shows the ideal declines of one year from 1892 to 1893, 1909 to 1910, 1926 to 1927, and 1943 to 1944. In the R phase, 1875 to 1876 and 1960 to 1961 become advances.

Each 1-, 2-, or 3-year movement is followed by a 16-, 15-, or 14-year movement to complete a 17-year cycle.

#### Advances in the Positive Phases and Declines in the Negative Phases

Chart VI,B, line 1, in the positive phase, shows on a yearly basis ideal advances of one year from 1891 to 1892, 1908 to 1909, 1925 to 1926, and 1942 to 1943. In the R phase, 1874 to 1875 and 1959 to 1960 become declines.

B2, in the positive phase, shows the ideal major two-year advances from 1893 to 1895, 1910 to 1912, 1927 to 1929, and 1944 to 1946. In the R phase, 1876 to 1878 and 1961 to 1963 become declines.

B3, in the positive phase, shows the ideal one-year advances from 1898 to 1899, 1915 to 1916, 1932 to 1933, 1949 to 1950, and late 1966 to 1967. In the R phase, 1881 to 1882 becomes a decline.

B4, in the positive phase, shows the ideal two-year advances from 1900 to 1902, 1917 to 1919, and 1934 to 1936. In the R phase, 1883 to 1885 becomes a decline.

B5, in the positive phase, shows the ideal two-

year advances from 1870 to 1872, 1904 to 1906, 1921 to 1923, and 1938 to 1940. In the R phase, 1887 to early 1888 is a decline, since 1888 is a reversal year. In the positive phase, 1888 to 1889 is an advance.

The major ideal tops of 1895, 1912, 1929, and 1946 are in the same series (A2), each 17 years apart. The major ideal bottoms of 1898, 1915, 1932, and 1949 are in the same series (B3), each 17 years apart. The major tops of 1902, 1919, and 1936 are in the same series (A4). The major bottoms of 1904, 1921, and 1938 are in Series B5. In the R phase, tops become bottoms, and vice versa. The major ideal tops of 1881 and 1966 and the major ideal bottoms of 1878 and 1963 are in the same series (A2).

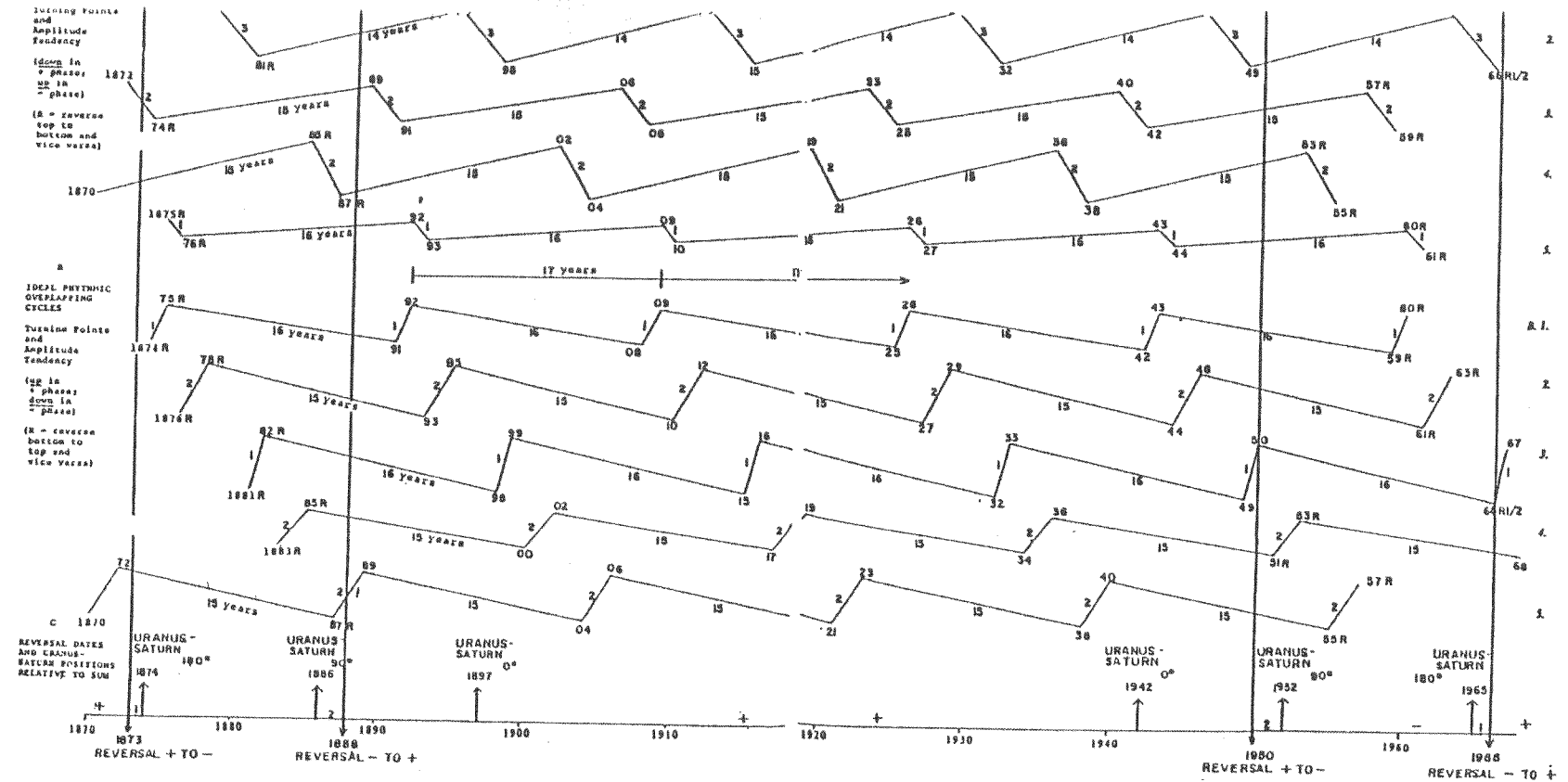
The many repetitions and correlations of the ideal and actual cycle patterns in terms of timing, duration, and amplitude tendency in the positive and negative phases would seem to point to non-random causes. This thesis is also supported by the fact that the 1873-88 reverse-phase pattern returns in the same timing form in the 1950-66 reverse-phase period. Moreover, the cycles of optimism and pessimism tend to persist and correlate to a high degree, regardless of war or peace or technological changes over a period of nearly a hundred years.

#### Emotions of Optimism and Pessimism May Be Influenced by Solar System

Medical-space research will be required to determine the exact mechanisms by which the emotions of optimism and pessimism are influenced; however, we can speculate that changes in electromagnetic forces or other changing patterns of

[39]

©2000 COWI



[40]

Chart VI. Overlapping Rhythmic Cycles and Timing of Reversals

[41]

solar system emissions and fields of force may be involved which could operate on the psychology of man through neurological and/or biochemical processes. It has long been known, for example, that changes in the ionization of the air can produce powerful physical, mental, and emotional effects.<sup>1</sup> Takata has found that the composition of human blood changes in relation to the sunspot cycle, to solar flares and sunrise, and to eclipses.<sup>2</sup> Jose concluded that certain dynamic forces exerted on the Sun by the motions of the planets were the cause of solar activity.<sup>3</sup> Bjorn, Hasseltine, and Pimm have developed techniques for the prediction of mean sunspot numbers using planetary influences.<sup>4</sup> Space research is discovering many planetary-solar-terrestrial relationships which may provide a key to the mechanisms involved.<sup>5</sup>

Many years of medical-ionization research for my paper, "Seasonal Cycles of the Common Cold and Their Relationship to Susceptibility,"<sup>6</sup> and my astronomy and planetary-solar-terrestrial research as a member of the American Geophysical Union and the New York Academy of Science, lead me to speculate that the rhythmic cycles may be related to the rhythmic movements of the planet Uranus relative to Saturn in their rotations around the Sun. Each of the 17-year rhythmic overlapping cycles seem to be related to the 43.36-year synodic period of Uranus and Saturn. The synodic period is the interval between two successive conjunctions (0°) of the two planets relative to the sun. The

1. See Appendix B, "Seasonal Peaks of Common Cold Incidence and Sunspot Activity."
2. Takata, Maki, *Time Magazine* (March 21, 1969).
3. Jose, Paul D., "Sun's Motions and Sunspots," *Astronomical Journal*, 70: 3 (April 1965).
4. Bjorn, T., Jr., Hasseltine, C. C., Pimm, R. S., "Prediction of Mean Sunspot Numbers Using Planetary Influences," American Geophysical Union, Annual Meeting, 1969.
5. Gauquelin, Michel, *The Cosmic Clocks*, Chicago: Henry Regnery (1967).
6. *Journal of Cycle Research* (1933); on file in the New York Academy of Medicine.

[42]

17-year period is equivalent to almost exactly 3/8 of the 43.36 period (3/8 of 43.36 is 17.01).

#### *Rhythmic Cycle Reversal Dates and Uranus-Saturn Positions*

The Uranus-Saturn hypothesis appears to be strongly supported by the dates of reversal from the negative to the positive phases, and vice versa (Chart VI,C, *Reversal Dates and Uranus-Saturn Positions*). The reversals in 1873, 1888, 1950, and 1966 appear to be related to the 180° and 90° positions of Uranus to Saturn relative to the Sun. As noted on Chart VI,C, the reversal in 1873 took place approximately 1 year before the Uranus-Saturn 180° position in 1874; the early 1888 reversal occurred approximately 2 years after the Uranus-Saturn 90° position of early 1886. In a similar manner, the 1950 reversal took place approximately 2 years before the Uranus-Saturn 90° position of early 1952 and the 1966 reversal occurred 1 year after the Uranus-Saturn 180° position of 1965. *In the 1870-1968 period the actual cycles and the ideal rhythmic cycles of optimism and pessimism in the positive and the negative phases appear to form a symmetrical pattern relative to the Uranus-Saturn 180° and 90° positions of 1874-86, respectively, the 0° of 1897 and 1942, and the 90° and 180° positions of 1952-65, respectively. This symmetry of the actual and ideal cycles in both the negative and positive phases tends to confirm a rhythmic pattern rather than chance or random events.*

#### *A Major Research Project Needed*

A major scientific-economic research project is suggested to confirm this new theory; to test its

findings versus the random-walk theory; to determine the exact quarterly or monthly turning points of the overlapping and composite cycles; and to investigate the specific cause of the 17-year patterns.

In the meantime, it will be interesting to note the degree and duration of fiscal and monetary actions that are needed to overcome and modify the influence of the timing and amplitude of the ideal rhythmic cycles of optimism and pessimism.

[43]

### Conclusions and Implications

The relatively high degree of timing, sequence, and amplitude tendency correlations between actual stock prices, other leading business indicators, private borrowing, and major business contractions and the ideal rhythmic patterns seem to confirm the existence of rhythmic cycles of optimism and pessimism rather than chance or random events as casual factors. It seems to refute the random-walk theory of stock price changes. This new theory is supported by the long series of rhythmic 17-year patterns, as illustrated in the composite and individual overlapping rhythmic cycles in both the positive and the negative phases. It appears that the causation of these rhythmic cycles and their phase reversals is of solar system origin and may be related to the rhythmic movements of the planets Uranus and Saturn relative to each other and to the Sun.

Monetary and fiscal policies do not appear to be the primary major causes of the business cycle, but appear to modify the amplitude and, to some extent, the timing for better or worse, depending upon the correctness of their timing, the strength of the action, and the concurrent influence of the confidence, liquidity, and ingenuity of lenders, borrowers, and spenders. It would appear that 1929 and 1932 would have been major turning

points regardless who had been President. Despite the importance of the influence of military and political decisions upon the economy, the business cycle in the private sector still persists.

The existence of rhythmic cycles of optimism and pessimism implies that economics is more of a science than has been recognized. It is therefore recommended that a major scientific research project be undertaken by the economic, medical, and space agencies of the federal government, in collaboration with universities and private research organizations, to determine a more accurate timing of the rhythmic cycles of optimism and pessimism and their phase reversals, and also to investigate the precise mechanism by which changes in the solar system's fields of force influence the human emotions of optimism and pessimism.

Cycle theory based upon the evidence presented here, together with further research to refine and project the cycles into the future, should be of valuable assistance in solving short- and long-range forecasting problems and in guiding fiscal action and monetary management for economic growth and stability and for a better balance between the objectives of full employment and price stability.

[44]

### Appendix



*Appendix A**Favorable and Unfavorable Factors  
in the Business Outlook and Their  
Influence Upon Business Confidence<sup>1</sup>*

At the present time the status of business sentiment is the most important factor underlying the current situation. More than ever, the psychological factor is at work. Therefore, although we might speak of various favorable and unfavorable factors as though they were independent forces, it should not be overlooked that the importance of most of these factors lies in their stimulating or depressing effect upon business confidence. It should also be realized that these various factors are so closely interrelated that changes in one lead to a series of changes in many of the others.

*Unfavorable Factors*

Without doubt, the most unfavorable factor at present is the deeply entrenched "fear of further

decline" in the minds of businessmen. As long as this lack of confidence exists, we cannot expect capital to flow into new enterprises, or purchases of new equipment and commitments of any sort to be made.

At present we find that purchasing agents are deferring 1938 buying, awaiting a further working off of inventories, which are still high in many industries. Buying is being held to a hand-to-mouth basis. Normally, contracts for 1938 supplies are signed at this time of year, but now they are being deferred until after January 1. This is perhaps unfortunate, for these are the fellows who must start the ball rolling again. It is the purchasing agents who help keep the capital goods industries going. A high rate of production in the capital goods industries increases purchasing power for consumer goods and leads to further stimulation of capital goods.

It is thus evident that whatever might dampen

[47]

1. A paper submitted at the Harvard Business School, November 26, 1937.

the confidence of the users of capital goods is of the utmost importance. In this region we find a number of unfavorable factors. In the first place, inventories are still high, and unfilled orders are practically nil. Moreover, commodity prices, especially raw materials, are still falling. This has a tremendous psychological effect, for when prices are falling, buyers are certain to hold off, so that prices fall still farther without possibility of immediate adjustment. Thus the volume of industrial production continues to decline, and this decreases the ability of the people to buy. This is evidenced by the present decline in payroll and, thus, in purchasing power.

Furthermore, the incentive for private capital to flow into industry on a large scale is weakening. The profit margins of many corporations are narrowing as a result of high costs, especially labor, and corporate inability to raise selling prices in the face of consumer resistance to a higher cost of living. Corporations are thus hesitant now about further expansion. This hesitancy is no doubt influenced by the tax on undivided profits. The reason is obvious. A few courageous businessmen, however, are still willing to take a chance at expansion, but they find that the slump in stocks and bonds has made new financing almost impossible. Recent new flotations are finding themselves on the shelves of the investment houses.

Can hope be expected to be offered by the railroad, automobile, or building industries?

In the railroad industry, we find that recent wage increases have practically crippled most roads, despite increased rates. To this is added the reduction in income because of the falling off in carloadings. The purchase of new equipment is being definitely postponed. Moreover, the industry is laying off countless workers.

The automobile industry has been watched

cagerly during the past month. Much hope for a stimulus to business was placed on this industry, for it is a huge purchaser of materials—steel, copper, glass, etc. But at the present time, we find that the automobile industry may disappoint us, for the response to the new models does not appear to be very encouraging.

In the building industry, the rate of decline is rapid. Despite a rise in rents through September, the high costs of building construction are still frightening away the speculative builders. To be sure, building is dependent to a great extent upon general business, but, at the same time, construction by builders who are confident that there is a need and a pressing demand for housing can stimulate other industries and directly and indirectly increase employment and purchasing power.

And so, steel operations are down to about 33 per cent of capacity. This low rate of operation is a depressing force, for besides resulting in unemployment and curtailment of expansion, it spreads fear to other industries. Wide fluctuations are a natural phenomenon in this industry, but this fact is not fully realized at this time.

Speaking again of confidence, we cannot overlook the stock market. Without doubt, the rapid collapse of stock prices was chiefly responsible for the sudden relapse of business sentiment. The current decline is further aggravating the situation. With reference to the stock market slump, in addition to its effect upon new financing and business sentiment in general, it is having an unfavorable effect on the will to buy of investors who are finding that their huge "paper profits" are being wiped out.

Turning to purchasing power, we find that there is a continuous decline. National income leveled off some time ago and is now drifting downward. The decline in government spending has, no doubt,

been a factor. As a result, retail trade is becoming less optimistic and is not holding up to expectations. Although consumer purchasing power is mainly dependent upon industrial production, the opposite is also true.

In this area we also find that the current trend of farm income is downward as a result of declining prices of farm products.

In the realm of labor, unfavorable developments are again taking place. Strikes are again breaking out in the automobile and rubber industries. This is by no means a healthy tonic for business sentiment.

In the money and banking situation, we should not overlook the declining volume of bank credit. Although it may be an indication of the working off of inventories, it is deflationary. As long as the supply of money and credit in circulation continues to decline, there will continue to be a decline in business spending. We should also note that the effect of the recent outflow of gold is deflationary.

In the international situation, we can probably always expect something unfavorable, but at the present time there is a decline in the rate of armament expansion, with a resultant slowing down of many dependent industries. As we are now well aware, business conditions in Europe greatly concern us because of financial interrelationships and because the price of many commodities is set in the world markets.

#### *Favorable Factors*

Here again we find that the more important factors for the near-term outlook are those which directly influence business sentiment.

It is from this angle that recent government statements and actions are important. Business

must have reason to feel that the administration is willing to cooperate. The actions of the President and Congress during the past week or more and in the near future may be able to turn the trend of sentiment.

Cooperation is being extended along several lines. In the first place, the President has promised the utilities that they can proceed with expansion without fear of government oppression, if they are willing to accept his theory of rate setting. It is estimated that cooperation with the utilities may release one to two billion dollars of capital expenditure. Already the New York State power companies have made plans for an outlay of \$112,000,000 during the next two years. If other utilities will follow suit, the estimated expenditure will give strong impetus to industrial activity and purchasing power. It might be pointed out, however, that with the present decline in the bond market, utilities will have a difficult time trying to float new issues.

Then again, the government has agreed to modify the undistributed profits tax and perhaps the capital gains tax. Already the House Ways and Means Committee has approved changes in the undivided profits tax which will be helpful to the smaller companies. At least a start has been made. If further favorable action is taken, which appears likely, it will be extremely helpful at the present time, for it will lift some of the obstacles to expansion, particularly in the financially weak companies.

A reduction in the capital gains tax, as is intimated, would stimulate the pouring of private capital into industry. A huge store of potential spending power is now lying idle in bank vaults or in tax-free securities, waiting for the profit incentive to be strengthened.

Moreover, the President is planning to initiate

a huge housing program. It is his intention to encourage the formation of large-scale construction corporations financially strong enough to carry on mass building projects. He may also accept the responsibility for controlling building costs. As has already been indicated, this action would tend to stimulate other industries, as well as directly adding a vast number of men to the ranks of the employed. However, if the government attempts to drop relief and other expenditures to balance the budget, municipal costs will continue to rise and threaten higher real estate taxes. Also, residential building depends mainly upon general business conditions and their effect upon the would-be house owner, so that attempts to stimulate construction of housing directly may prove to be difficult.

Another favorable factor may be the intention to revive RFC lending. This would help railroads finance needed capital improvements at a time when income is very low. Also, managements are anticipating ICC permission to further raise rates to offset wage increases.

In the realm of government action, the present negotiations with Great Britain for a reciprocal trade agreement would stimulate exports.

It should be realized that it may take time for the government to actually carry out its plans, but a definite decision to act will in itself buck up business sentiment.

Turning to industry itself, we find encouragement in the fact that inventories are being worked off, because of the prompt adjustment of production to the lowered demand. This means that as soon as sentiment improves, production will quickly respond to increased demand. Also, there has been no overexpansion of production facilities in the leading industries. Furthermore, most of the leading companies are in a strong financial

position. These facts are important because they indicate that most corporations will not blindly attempt to sell their products at almost any cost in the hope of getting some contribution to overhead and preventing themselves from going under.

In the labor situation there is some hope, despite the recent outbreak of strikes. The present negotiations between the CIO and the AFL may lead to more conservative labor activities, for much of the strike activity is the result of a battle for leadership between the two organizations. The recent defeat of the CIO candidates in the Detroit elections might slightly dampen the confidence of CIO heads.

As for agriculture, there are some favorable aspects. Despite the continuous decline in the price of most farm products, farm income is still ahead of last year. As a result, it is anticipated that farmers will be in the market for an increased amount of farm equipment, clothing, etc. Furthermore, the President's desire to assist the farmer at this time may be helpful in maintaining his purchasing power.

In the security markets we find more steadiness than last month. The market has probably already overdiscounted the present decline in business. The day-to-day movements seem to be greatly dependent upon government action, which bears out our opinion that government action is now extremely important in stimulating business confidence.

The greater steadiness of the market may be partly due to the revised margin requirements. The action by the FRB indicates that Washington is greatly concerned over the unfavorable trend in securities and realizes its effect upon general business.

In the money and banking situation there are certain bright spots. Excess reserves are still large

and interest rates are low, thus providing a large base for credit inflation. The rediscount rates charged by the FRB are exceedingly low; this offers some assurance against deflation. It is true that bank credit is declining rapidly, but, as has been noted, the downtrend of bank loans may be a favorable sign, indicating that business is reducing inventories. Some writers point with alarm at this decline in bank credit and consider it to be a major cause of the business decline. There is no doubt that the decline in investment holdings by the banks is deflationary, but if it continues, I believe the FRB will take steps to reverse the trend. It appears that the Federal Reserve Board will keep

itself fully awake during the next few months.

As for the international situation, there is more reason for hope than for fear. The high state of tension that prevailed in Europe during the summer is gradually subsiding. Our nervousness over the possibility of a major war now is greatly abated. This is taking a great load off the minds of both the administration and businessmen.

Finally, all the members of the House and a third of the Senate face election next fall. These officeholders will attempt to do something to which they can point with pride. Such efforts would be definite action that would put the brakes on the present business decline.

## Appendix B

*Seasonal Peaks of Common Cold  
Incidence and Sunspot Activity<sup>1</sup>*

The phenomena of September-October and February-March peaks, on average, for both the common cold and sunspot activity appear to be related through the mechanism of ionization produced by X-radiation. The resultant decreased CO<sub>2</sub> absorption by the blood plasma, the acid-alkaline imbalance, and impaired oxygen consumption lower resistance and provide an environment for common cold viruses to attack.

Studies of the common cold indicate that two peaks of incidence often occur during the year—a major one, on average, between September and October, and the other between February and March. The peaks of incidence, noted in a study by Torney and Lake<sup>2</sup> of employees of Macy's department store in New York City, occurred in October and February. Downes<sup>3</sup> found a big peak in September and one in February-March among

persons of ages 19 and over as well as ages 5-18, in a study conducted in Westchester County, New York. Dingle<sup>4</sup> found a September peak among a Cleveland, Ohio group. On the basis of years of research, Dr. Perrin Long of the Department of Medicine of the Kings County Hospital, considers the phenomenon of the September-October and February-March peaks, rather than one continuous peak from September to March, as one of the greatest mysteries of the common cold.<sup>5</sup>

Studies of sunspots indicate that there are often two similar peaks—one, on average, between September-October, and the other, on average, between February-March. Clayton<sup>6</sup> found two maximum areas of sunspots each year for the period 1887-1938—one peak averaged between February and March and another averaged between Sep-

tember and October. Arctowski,<sup>7</sup> studying sunspot numbers for the period 1874-1913, found a peak averaged in September and the next averaged in February. Hess and Huyslic<sup>8</sup> confirm the existence of regular seasonal variations in sunspot numbers. Reports on the International Geophysical Year 1957-58 indicate that in September 1947 the intense solar activity produced auroras that could be mapped on twenty-five nights. The great auroral storm of February 10-11, 1958 was one of the most spectacular in many years. In March 1958, auroras were seen on every night except one. The "Observed Sunspot Numbers"<sup>9</sup> for this period show one peak in September-October 1957 and another in February-March 1958. Perhaps the sun's crossing of the equator in September and March is a factor.

The similarity of the seasonal peaks of common cold incidence and sunspot activity indicate a relationship between these two phenomena; the former appears to be caused by the latter. The mechanism of the relationship appears to be the change in ionization of the atmosphere during increased sunspot activity.

Sunspot activity produces X-rays that increase the ionization of the atmosphere. Freidman<sup>10</sup> and his associates at the Naval Research Laboratory discovered X-rays at times of solar flares in the lower D region of the atmosphere. His studies indicate that this X-radiation creates the increased ionization which leads to radio communication blackouts at times of intensive solar activity, while ultraviolet radiation does not. Soviet papers presented at the Fifth General Assembly of the

Special Committee for the International Geophysical Year indicate the relative abundance of positive ions as a result of sunspot activity. Tchi-jevsky<sup>11</sup> conducted a series of studies on sunspot numbers and concluded that increased electrical activity around the sunspot maxima increases the positive ionization of the air. Apparently, there is greater leakage of charged particles to the earth's lower atmosphere than is generally suspected.

Positive ionization appears to have many adverse influences. A two-year study by a research team at Northeastern Hospital, Philadelphia, headed by Dr. Igho H. Kornbluch of the hospital and Dr. George M. Piersol, dean of the University of Pennsylvania Graduate School of Medicine, indicates that when the air is charged with positive ions, there is a notable increase of discomfort in the form of fatigue, dizziness, headache, asthma, and sinusitis. They reported that negative ions have a beneficial influence. Puck and Sagik<sup>12</sup> have shown that viruses attach themselves to cells only when positive ions are present.

Physiologically, positive ionization affects the CO<sub>2</sub> absorption by the blood plasma and the acid-alkaline balance and impairs the O<sub>2</sub> intake and consumption. Professor John L. Worden,<sup>13</sup> of St. Bonaventure University, presents evidence that a positively ionized atmosphere decreases the ability of the blood plasma to combine with CO<sub>2</sub> and influences the acid-alkaline balance adversely. Hall-dene and Priestly, explaining the mechanism of the changes in rate of O<sub>2</sub> intake, show that the accumulation of CO<sub>2</sub> in the blood causes the respiratory center to be stimulated so that it sends in-

1. A paper for the Petco Research Laboratory, New York, July 14, 1959.  
2. Torney and Lake, *Journal of the American Medical Association*, 117 (1924, 1941).  
3. Downes, *Milbank Memorial Fund Quarterly*, 30 (1932).

4. Dingle, John, "A Study of Illness in a Group of Cleveland Families," *Journal of Hygiene* (January 1933).  
5. Dr. Long's presentation of this mystery inspired the research for this paper.  
6. Clayton, *Solar Cycles*, Smithsonian Misc. Collection, 106: 22 (1947).

7. Arctowski, *Mém. Soci. Spéthroscopistii*, 5 (1916), 98-99.  
8. Hess and Huyslic, *Cosmic Radiation and Its Biological Effects*.  
9. *Predicted and Observed Numbers*, Department of Commerce, National Bureau of Standards, Boulder, Colorado.  
10. Odishaw, Hugh, "International Geophysical Year," *Science*, 128 (December 26, 1958), 3339.

11. Dewey, Edward A., and Dakin, Edwin P., *Cycles—The Science of Prediction* (chapter 10). New York: Henry Holt (1934).  
12. Puck, H. P., and Sagik, A. C. (October 1934).  
13. Worden, John L. Paper to the American Society for Experimental Biology.

pulses to the muscles of respiration, causing more rapid breathing and consequently more oxygen intake; on the other hand, decreased CO<sub>2</sub> in the blood plasma reduces O<sub>2</sub> intake. The acidity-alkalinity imbalance, as well as low CO<sub>2</sub> content, influences oxidation adversely. Gray<sup>14</sup> confirms this O<sub>2</sub> phenomenon. Peterson<sup>15</sup> shows that the pH changed and the CO<sub>2</sub> content was low two days before the onset of the common cold.

Adequate O<sub>2</sub> intake and unimpaired oxidation are essential for adequate heat production to avoid a thermal imbalance, the green light for possible common cold viruses to attack. In my paper, "Seasonal Cycles of the Common Cold and Their Relationship to Susceptibility,"<sup>16</sup> it is shown that the common cold viruses apparently strike or develop when a thermal imbalance develops. This imbalance lowers resistance and provides an environment for the common cold viruses to attack. In-

creased sunspot activity, by decreasing oxygen consumption, therefore, tends to increase susceptibility to the common cold viruses. This explains the similar peaks of incidence.

This relationship of the common cold to sunspot activity throws some light on the mysteries of the common cold. It may also indicate other interrelationships of phenomena in the upper atmosphere and terrestrial events; for example, the severe influenza epidemic in the fall of 1957 and the winter of 1958 coincided with the high 1957-58 sunspot activity.

#### *Postscript, March 1969*

(1) The Hong Kong flu epidemic of 1968-69 coincided with the high 1968-69 solar activity.

(2) Since the Apollo 7 and 9 astronauts broke out with colds during the high sunspot activity in October 1968 and in February 1969, my common cold research findings are being evaluated by the chief of the Astronauts' Clinic, NASA Manned Spacecraft Center.

14. Gray, John S., "The Multiple Factor Theory of Respiratory Regulation," Project 386, Report 2: *Uncompensated Metabolic Disturbance of Acid-Base Balance*, A.A.P. School of Aviation Medicine (December 14, 1943).
15. Peterson, William F., *The Patient and the Weather*. Ann Arbor, Michigan; Edwards Brothers (1958).
16. *Journal of Cycle Research*, 4:3 (July 1955), 65-72.

*Appendix C*

*The Pentagram Star  
And Golden Triangle*

*Reprinted From:*

*The Divine Proportion  
A Study in Mathematical Beauty*

*by H.E. Huntley*



are easily verified, taking  $R, r$  as the radii of the circumcircles of the pentagons  $A'B'C'D'E'$  and  $P, Q, R, S, T$  respectively, and  $PQ$  as of unit length.

- i.  $A'P = \phi$
- ii.  $OA/r = \phi/2$
- iii.  $OA'/r = \phi^2$
- iv.  $OA'/OA = 2\phi$
- v. A diagonal such as  $QS$  has length  $\phi$ .
- vi. If  $X$  is the point of intersection of two diagonals  $PR, QS$ , then

$$\frac{SX}{XQ} = \phi, \quad \frac{PX}{XR} = \phi \quad \text{and} \quad \frac{B'X}{XT} = \phi$$

- vii. If  $SQ$  produced meets  $A'B'$  in  $V$ , then, since  $VQS$  is parallel to  $A'D'$ ,

$$\frac{B'V}{VA'} = \frac{B'Q}{QP} = \frac{B'X}{XT} = \frac{B'S}{SD'} = \phi$$

- viii. The lengths of the six segments  $B'D', B'S, B'R, RS, RX, XZ$  are in geometric progression.

$$\begin{aligned} B'D' &= \phi^3 \\ B'S &= \phi^2 \\ B'R &= \phi \\ RS &= 1 \\ RX &= \phi^{-1} \\ XZ &= \phi^{-2} \end{aligned}$$

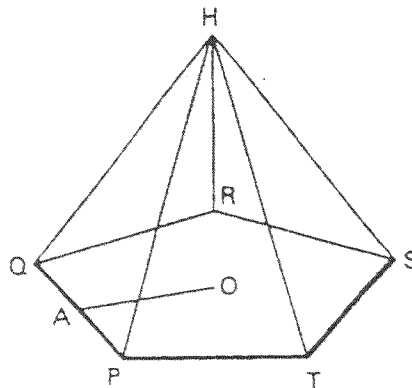


Fig. 2.5. Folded pentagram



The series is also an additive series: the sum of two consecutive members equals the next, e.g.,  $\phi + \phi^2 = \phi^3$ .

ix. The length of a side of the pentagon  $A'B'C'D'E'$  is  $\phi^2$ .

x.  $R/r = \phi^2$ .

By folding  $\triangle A'PQ$  about  $PQ$  and treating the other corresponding triangles similarly, so that  $A', B', C', D', E'$  meet in  $H$ , (Fig. 2.5) we have a pyramid of height  $OH$ .

xi.  $OH/OA = 2$

xii.  $OH/r = \phi$

#### THE PYTHAGOREAN BROTHERHOOD

The pentagram star was also regarded by members of the ancient society of Pythagoras as a symbol of health. Probably the five angles were denoted by the letters  $\Upsilon\Gamma\text{I}\Theta\text{A}$ , the Greek word for health ( $\Theta$  standing for the diphthong EI).

A Greek writer, Iamblichus, tells us that a member of the Pythagorean fellowship, while travelling far from home, stayed one night at a wayside inn. He fell ill, and despite the care of a sympathetic landlord, who tried at considerable expense to restore him to health, he died. Before his death, recognizing that his situation was desperate and being unable to compensate his host, he had obtained a board and on it had inscribed a pentagram. Giving this to the landlord he had requested that it might be fixed where all passers-by would see it. In due course a traveller riding by saw the symbol. Dismounting he made enquiries and, on hearing the story of the landlord, generously recompensed him. We may assume, I think, in view of his generous and disinterested treatment of a wayfaring student, that the landlord made no further use of the board inscribed with the triple star.

A rectangle, the sides of which are in the golden ratio, is called the golden rectangle. Its shape appears to have aesthetic attractions superior to that of other rectangles. The evidence, based on experiments in psychology, is presented in chapter V. Whatever the truth of the matter, there seems to be no doubt that Greek architects made use of this form in their designs. An example is seen in the representation of the Parthenon in chapter V (Fig. 5.2). More significantly, the golden rectangle is associated

40

THE DIVINE PROPORTION

As a simple example let us solve the equation:

$$\sin 2\theta = \cos 3\theta$$

Can you see *Phi* lurking in these innocent symbols? Since the sine of an angle is the cosine of its complement,  $2\theta + 3\theta = \pi/2$  or  $\theta = \pi/10$ .

The equation may be reduced to

$$4 \sin^2 \theta + 2 \sin \theta - 1 = 0$$

Thus,  $\sin 18^\circ = \frac{1}{2}(\sqrt{5} - 1)/2$  or  $-\frac{1}{2}(\sqrt{5} + 1)/2$ . Taking the positive value,

$$\sin 18^\circ = -\phi'/2, \text{ whence } \cos 36^\circ = 1 - 2 \sin^2 18^\circ = \phi/2$$

THE GOLDEN TRIANGLE

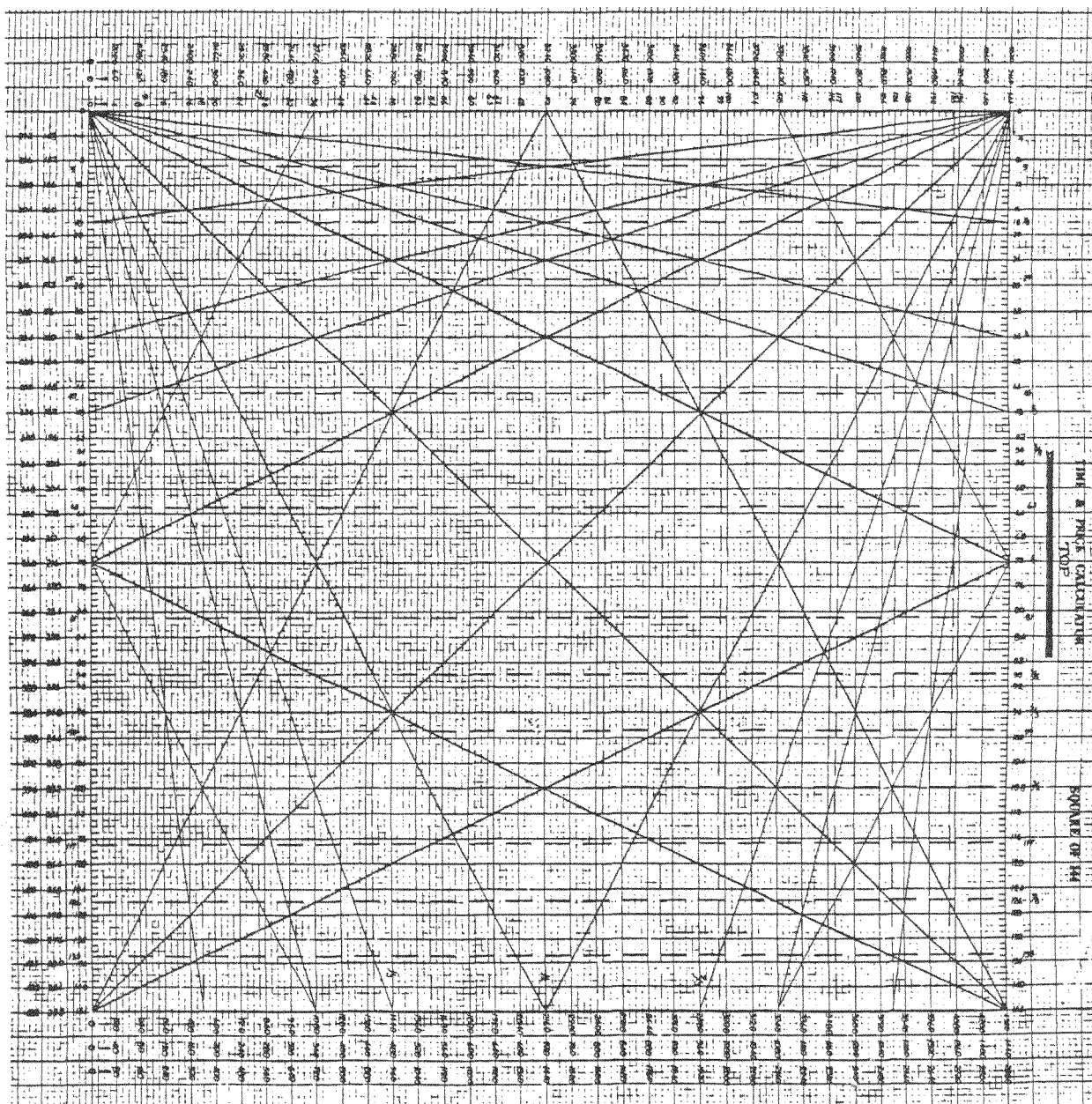
These and similar results are collected in figure 3.1 and the table that follows:

Angle		$(2 \sin)^2$	$(2 \cos)^2$
$\pi/20$	$9^\circ$	$2 - \sqrt{\phi + 2}$	$2 + \sqrt{\phi + 2}$
$\pi/10$	$18^\circ$	$\phi' + 1$	$\phi + 2$
$3\pi/20$	$27^\circ$	$2 - \sqrt{\phi' + 2}$	$2 + \sqrt{\phi' + 2}$
$\pi/5$	$36^\circ$	$\phi' + 2$	$\phi + 1$
$\pi/4$	$45^\circ$	$\phi + \phi'$	$\phi + \phi'$
$3\pi/10$	$54^\circ$	$\phi + 1$	$\phi' + 2$
$7\pi/20$	$63^\circ$	$2 + \sqrt{\phi' + 2}$	$2 - \sqrt{\phi' + 2}$
$2\pi/5$	$72^\circ$	$\phi + 2$	$\phi' + 1$
$9\pi/20$	$81^\circ$	$2 + \sqrt{\phi + 2}$	$2 - \sqrt{\phi + 2}$

The solutions of the equation  $x^2 - x - 1 = 0$  have been given as

$$\begin{aligned} \phi &= 1.61803 & \phi + \phi' &= 1 & \text{and } \phi \cdot \phi' &= -1 \\ \phi' &= -0.61803 & \phi^2 &= \phi + 1 & &= 2.61803 \end{aligned}$$





<sup>69</sup> Revelation 21:17. He measured its wall and it was 144 cubits thick, by man's measurement, which the angel was using.



-2-

The opposition angle, which runs thru the center of the Square, from east to west, equally dividing it, is one of the very strong angles because it equals one-half. Any stock moving up or down and reaching these prices will meet with any resistance and make tops or bottoms. These numbers are 6, 7, 18, 19, 30, 31, 42, 43, 54, 55, 66, 67, 78, 79, 90, 91, 102, 103, 114, 115, 126, 127, 138, 139.

Remember, when anything has moved three sections over from the beginning, it reaches the square of its own place, which is the first strong resistance. When it has moved six sections over, it reaches the opposition, or what equals the half way point of its own place and meets still stronger resistance. Moving over nine places or sections from its own place, it reaches the 3<sup>rd</sup> point, another square. The 8th and 9th sections are the strongest and hardest points to pass because this is the "death" zone. The next and still stronger is the 12th section or column which ends at 144. Anything getting into this section meets the strongest resistance but once it moves out of this square and gets as much as 3 points into Square #2, that is, making 147, will indicate much higher. But after reaching this, it should not drop back to 141 or 3 points into Square #1.

When a stock gets into the Second Square of "12", it has faster moves, and when the time or number of months from any bottom or top moves into the Second Square, it is an indication of faster moves, both up and down.

Apply the same rule to the 3rd, 4th, 5th and 6th Squares. In the 3rd and 4th squares of the Master "12", you will find that most of the big bull and bear campaigns culminate, when measured by months, which determines the division, according to time. All of the other rules given you to apply to Space movements, angles and time, can be used with the Master "12" tables.

#### SQUARE OF NINE

You have already had the MASTER SQUARE OF TWELVE explained, which represents days, weeks, months and years, and the measurements of TIME in the Square of Twelve or the square of the Circle; also used to measure price movements and resistance levels.

The SQUARE OF NINE is very important because nine digits are used in measuring everything. We cannot go beyond 9 without starting to repeat and using the 0. If we divide  $360^{\circ}$  by 9, we get 40, which measures 40<sup>o</sup>, 40 months, 40 days, 40 weeks or 40 months, and shows why bottoms and tops often come out on these angles measured by one-ninth of the circle. This is why the children of Israel were 40 years in the wilderness.

If we divide our 20-year period, or 240 months, by 9, we get  $26\frac{2}{3}$  months, making an important angle of  $26\frac{2}{3}^{\circ}$ , months, days or weeks. Nine times 9 equals 81, which completes the First Square of Nine. Note the angles and how they run from the main center. The Second Square of Nine is completed at 162. Note how this is in opposition to the main center. The Third square of Nine is completed at 243, which would equal 243 months or 3 months over our 20-year

## Appendix E

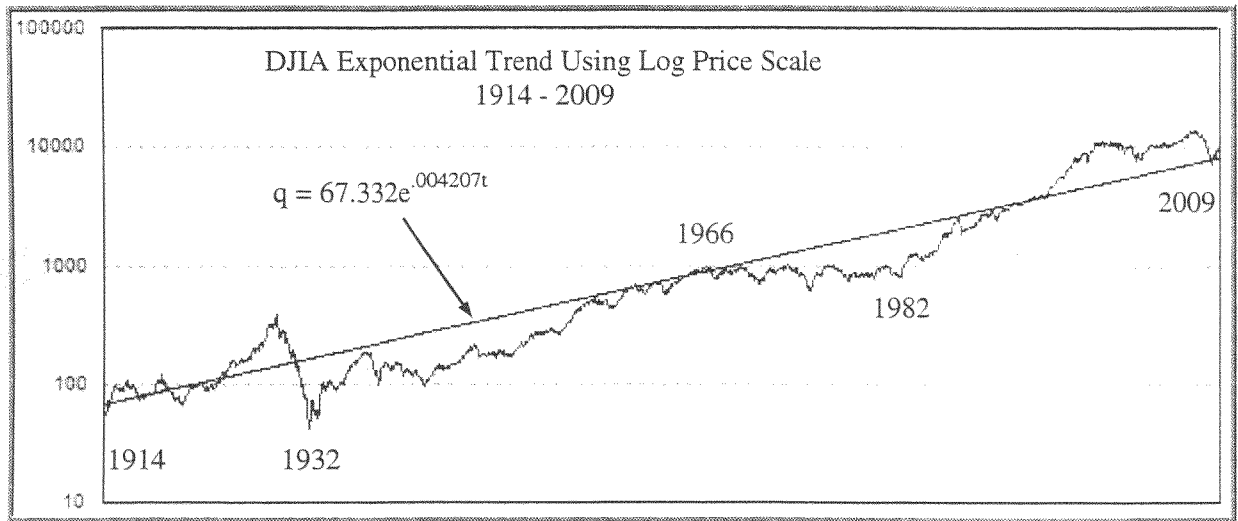
## Stock Market Natural Growth Equation

Before looking for a long-term cycle in any market it is helpful to first remove the exponential trend. One common way to do this is to chart long-term data with a logarithmic price scale, as shown in Chart E.1. This magnifies the earlier, smaller, price swings by removing the exponential arc, leaving a linear trend. But it still does not flatten out the chart enough to clearly isolate the cycles.

A clearer way to isolate the cycles is to divide the equation for natural exponential growth,  $q = q_0 e^{kt}$ , into the market data giving a sideways moving chart.<sup>70</sup>

The equation for the stock market has already been derived and can be entered into a spreadsheet such as Excel or Quattro Pro to easily work with the data. Figure E.1 shows how the equation is entered into Quattro Pro but any spreadsheet can be used with minor changes in the menus.

Column A is the date, B is the monthly close, C is the result of the exponential growth equation, and D is column B divided by column C<sup>71</sup>.



**Chart E.1**

Monthly DJIA close with exponential trend using a logarithmic price scale.

<sup>70</sup> The equations used to detrend the data beginning in 1790 are derived in *Four-Dimensional Stock Market Structures And Cycles*, Appendix B.

<sup>71</sup> To divide column B by column C enter "+B1..B1130/C1..C1130", where 1130 is the number of months.

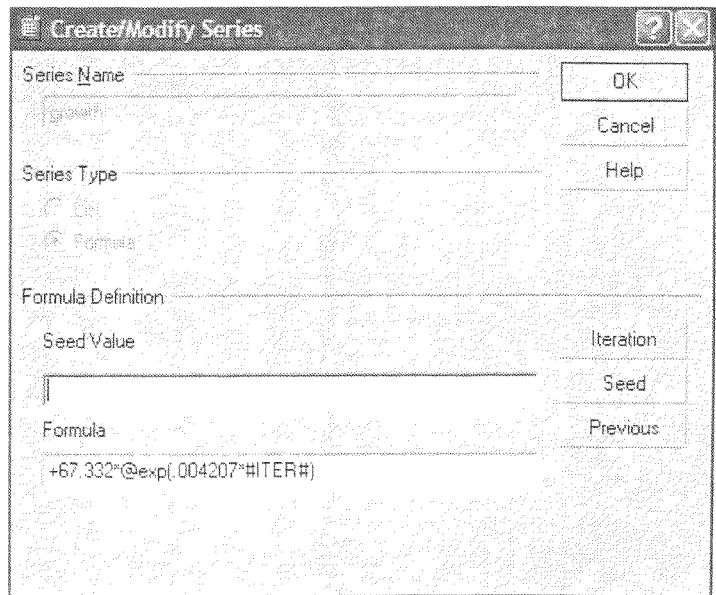
From the Quattro Pro menu:  
Edit -> Fill -> QuickFill

+67.332\*@EXP(.004207\*#TER#)

#TER# is inserted when you click the Iteration button.

This will fill the selected spreadsheet cells with results from the stock market growth equation, as shown in Figure E.2, column C.

**Figure E.1**  
Growth equation in Quattro Pro.



	A	B	C	D
1	Date	Monthly Close	Exponential Growth	B / C
2	19141231	54.58	67.6158624099096	0.807207
3	19150130	57.16	67.9009215445229	0.8418148
4	19150227	55.18	68.1871824490662	0.809243
5	19150331	60.83	68.4746501900353	0.888358
6	19150430	71.78	68.763329855286	1.0438703
7	19150529	64.67	69.0532265541235	0.9365239
8	19150630	70.06	69.3443454173933	1.0103203
	⋮			
			To 2009	
1121	20080331	12262.89	7491.13504603593	1.6369869
1122	20080430	12820.13	7522.71663647028	1.7041889
1123	20080531	12638.32	7554.43137052683	1.6729677
1124	20080630	11350.01	7586.27980952068	1.4961233
1125	20080731	11378.02	7618.26251713338	1.493519
1126	20080831	11543.55	7650.38005942289	1.5088858
1127	20080930	10850.66	7682.63300483357	1.4123621
1128	20081031	9336.93	7715.02192420627	1.2102273
1129	20081130	8829.04	7747.54739078843	1.1395916
1130	20081231	8776.39	7780.20998024422	1.1280402
1131	20090131	8000.85	7813.01027066474	1.0240419

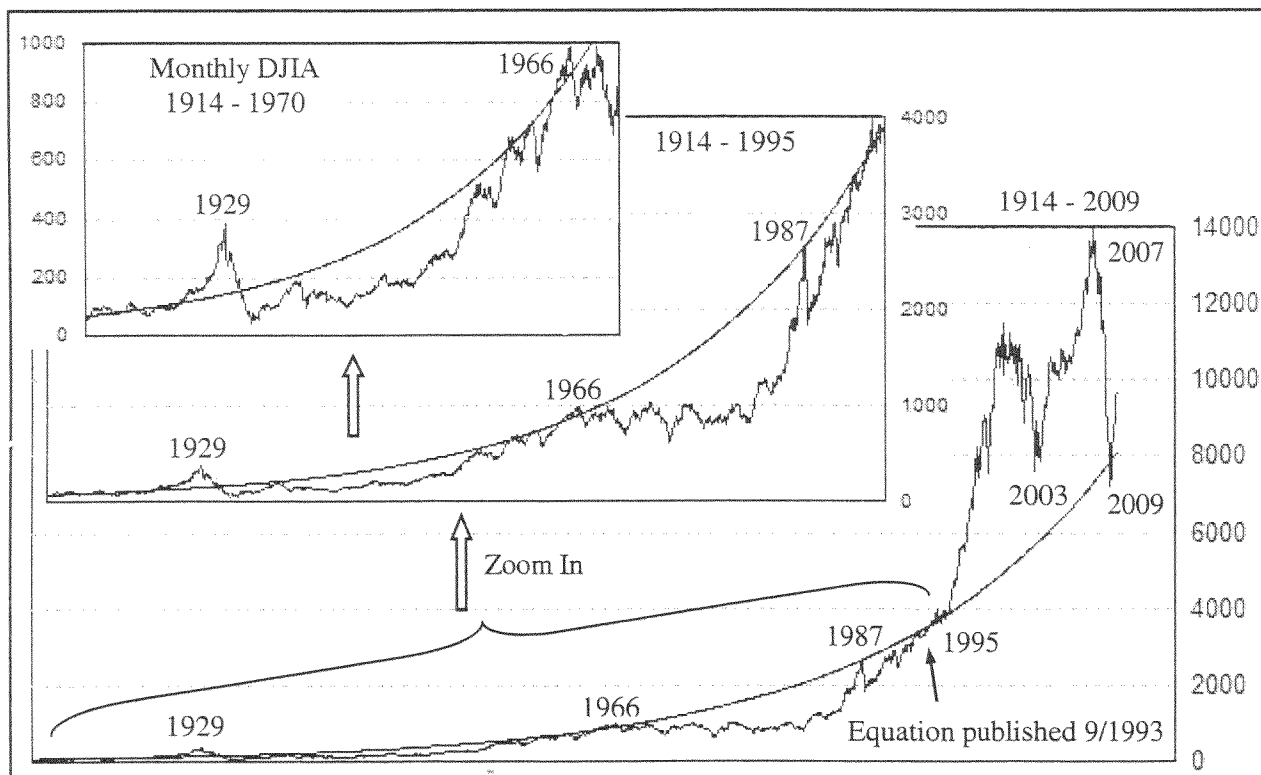
**Figure E.2**  
Spreadsheet data of natural growth equation, 1914-2009.



Chart E.2 plots the monthly close together with the growth curve. The chart on the bottom is the entire data range from 1914 to 2009. The curve starts flat because price swings were much smaller in earlier years. Two additional charts zoom in on the earlier data to get a better view of how the actual prices followed the growth curve. Notice how the curve defined the end of trends in many places, 1937, 1966, 1987, and the breakout in 1995. The 2007-2009 plunge from over 14,200 to below 7000 returned to the trend line defined by the natural growth equation. It is amazing that a growth equation originally published 16 years ago in 1993, with 1914 as its origin, and derived from data nearly 100 years ago when the index was at 55, is still producing a trend result that follows today's DJIA data. But do not make the mistake to think a trend line lasting hundreds of years can be used effectively in your trading because

deviations from this trend can last many years. And the magnitude of the moves away from this trend can cause prices to double or triple, as in 1995-2007. But historically, the prices have always eventually return to this curve. The true value of the curve is not in a trading strategy but to isolate the cycles, which can then be used in trading and investing.

*Four-Dimensional Stock Market Structures And Cycles* used this technique to produce Charts VIII.A and VIII.B, which are reproduced below in Appendix I, Chart I.2. Notice the price axes on these charts show the data as a deviation from the underlying trend. This means the data has been detrended by removing the exponential growth.



**Chart E.2**

Monthly close with exponential trend. Upper charts zoom in to earlier dates.

## Appendix F

## Planetary Angles Between Two Dates

When doing research its helpful to be able to quickly find the distance a planet, or combination of two planets, has moved between two dates or bars on a chart.

In the Cycle Timer<sup>72</sup> Options menu uncheck the box to "Show Cycle Dates Instead of Counts". This will tell how many cycles have occurred since the beginning.

Delta Degree



Chart F.1

Finding planetary displacement between two bars.

<sup>72</sup> CycleTimer software can be downloaded for a free 15-day trial at [www.cycle-trader.com/program/download.htm](http://www.cycle-trader.com/program/download.htm)

Then put a multiple of 10 into the "Delta Degree" box. If you are using a slower moving planet you would use 100 or 1000, depending on the speed of the planet.

Either move the crosshairs to where the cycle is to start or enter the date manually in the Manual menu.

In this example the top in 1937 was slightly before 4 cycles of 10 degrees, or 40 degrees. Using an estimate based on the spacing back to 30 you would enter 39 in the delta degree box and recalculate until you get the correct displacement.

With practice this whole process takes about 10 seconds until you get close enough for your analysis.

You can also scroll through your chart and click the planet icon to recalculate the cycles and see where it repeated in the future or past.



Chart F.2

Calculating planetary displacement between two dates or bars on a chart

## Appendix G

## $\Phi^3$ Pentagonal Expansion Of Planetary Cycles

Figure 10.2 showed that to expand a pentagram to the next larger energy level the side of the inner pentagon is multiplied by  $\Phi^3$ , or 4.236. CycleTimer allows the user to calculate and plot this expansion on his charts using planetary degrees.

For example during the 12/12/1914 to 2/27/1933 17-year cycle Uranus moved 71.77 degrees. To automatically expand this cycle length by  $\Phi^3$  put 4.236 in the menu

item "Dynamic Expansion Ratio" and 71.77 in "Delta Degree", as shown below. The  $\Phi^3$  expansion of this side arrived at the 2002 bottom.

Often the movement of a planet or combination is  $305^0$ . This is because it is the  $\Phi^3$  expansion of a  $72^0$  pentagon:

$$305^0 = \Phi^3 \times 72^0$$

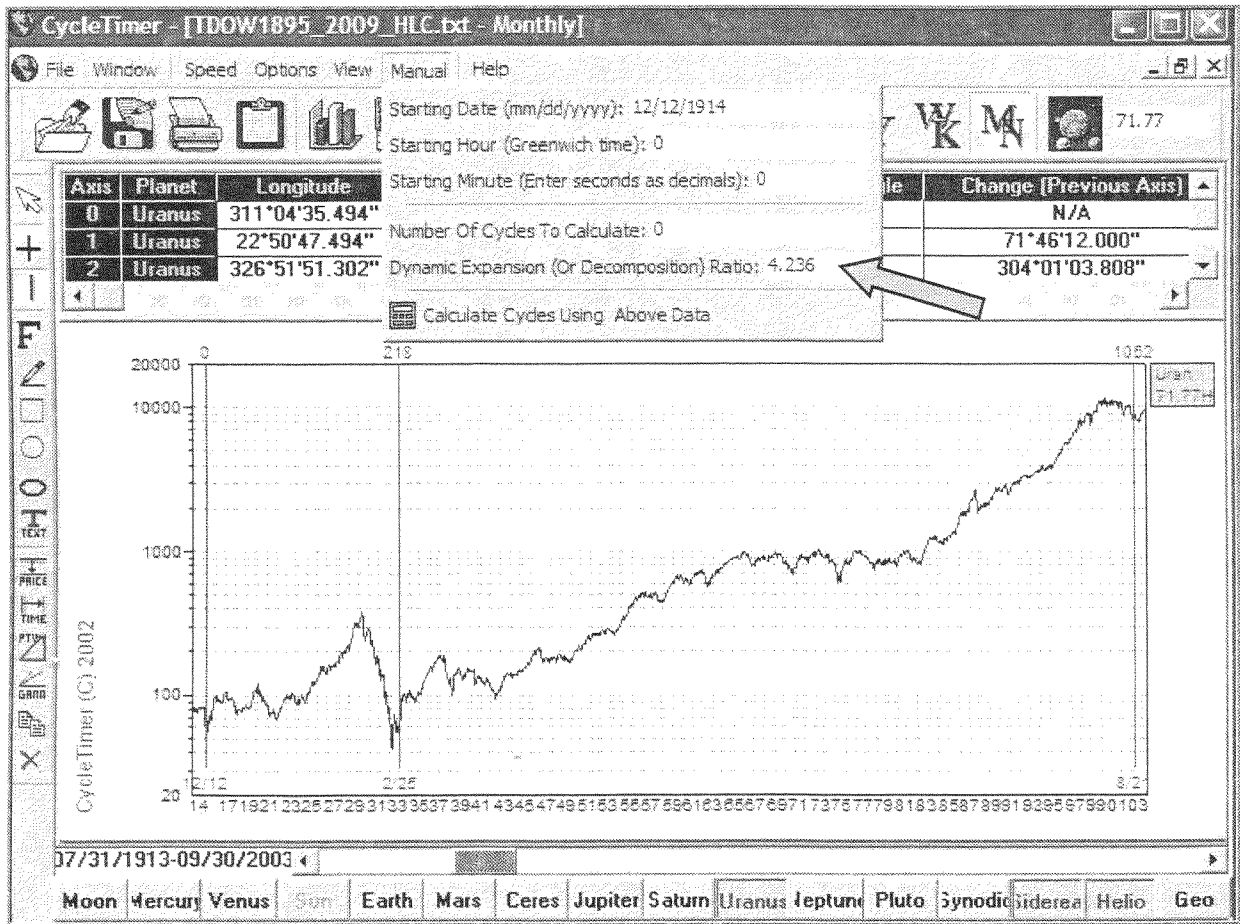
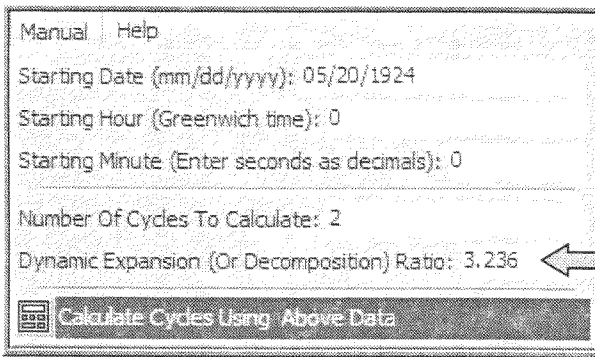


Chart G.1

$\Phi^3$  expansion of the Uranus 17-year cycle.

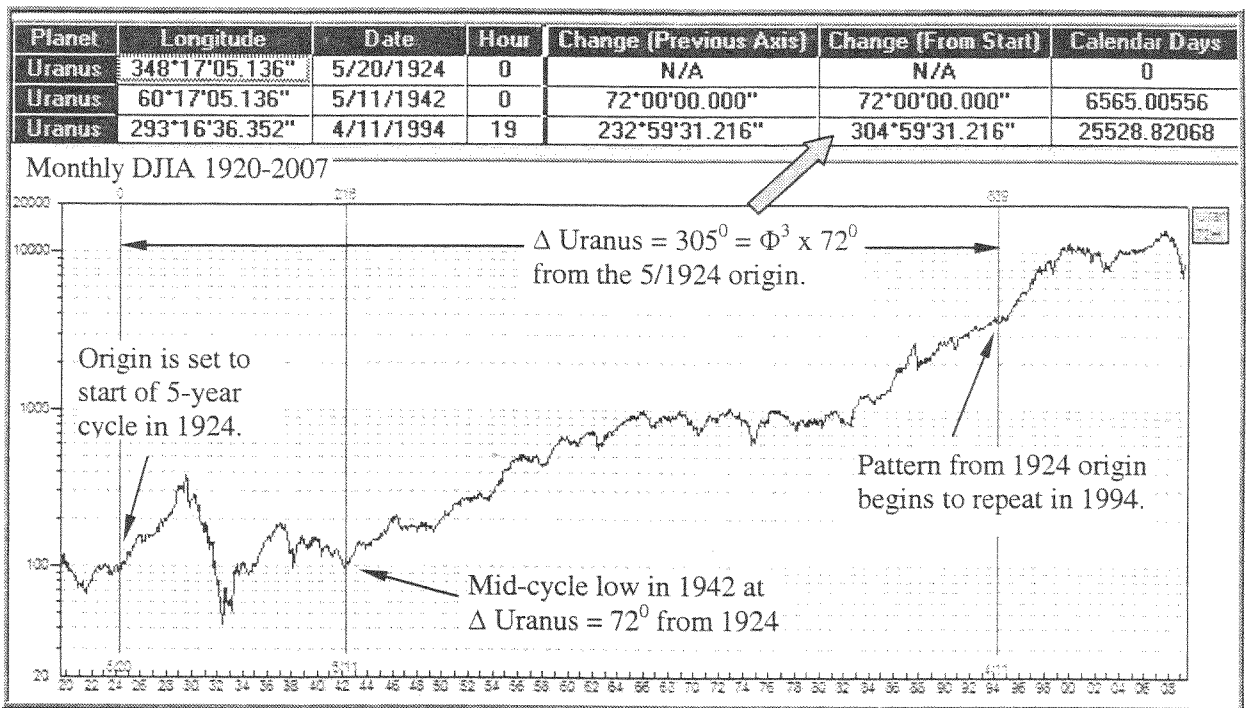
Enter 3.236 instead of 4.236 in the Dynamic Expansion Ratio menu to expand  $\Phi^3$  from the origin instead of the first cycle.  
 Subtracting one from the ratio effectively moves the cycle back unity, or the first recurrence. This is a very valuable tool that gives the pentagonal expansion from the inner side of the pentagon to the entire span of the unfolded pentagram. Reference the chapter on *Repeating Market Patterns* for the example given below.

Chart G.2 shows that anchoring the cycle at the 5-year cycle low in 5/20/1924 and first advancing  $72^\circ$ , then advancing  $305^\circ$  ( $72^\circ \times \Phi^3$ ), gives the mid-cycle low in 1942 and 1994 when the pattern begins to repeat. The cycles aligned with Uranus had moved out to the higher energy level or larger pentagram.



**Figure G.1**  
 CycleTimer menu settings for  $\Phi^3$  dynamic expansion from origin.

Use 3.236 ( $4.236 - 1$ ) for  $\Phi^3$  expansion from the origin in 1924. 4.236 entered here expands  $\Phi^3$  from the first cycle in 1942.



**Chart G.2**

Uranus dynamic expansion ratio of  $\Phi^3$  from 1924 is where the pattern begins to repeat.

## Appendix H

## Borobudur, Java And The Square Of Twelve

Readers of *Four-Dimensional Stock Market Structures And Cycles* know that one of the author's interests is studying ancient temple geometry. The sixteen years since that publication has allowed many more temples from many locations around the world to be studied. Among the favorites are Borobudur and Prambanan in Java, Indonesia. These temples are mostly intact and compared to others in areas like Myanmar, Cambodia, or Laos are relatively easy to access.

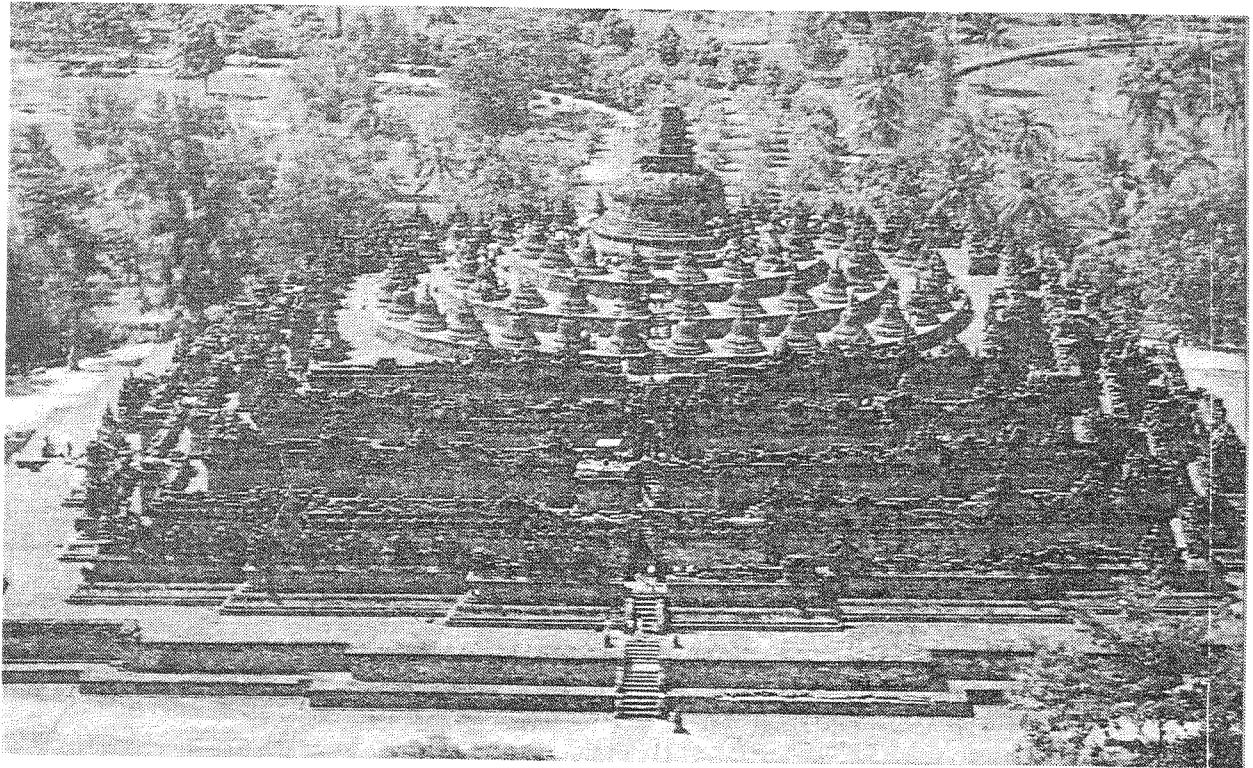
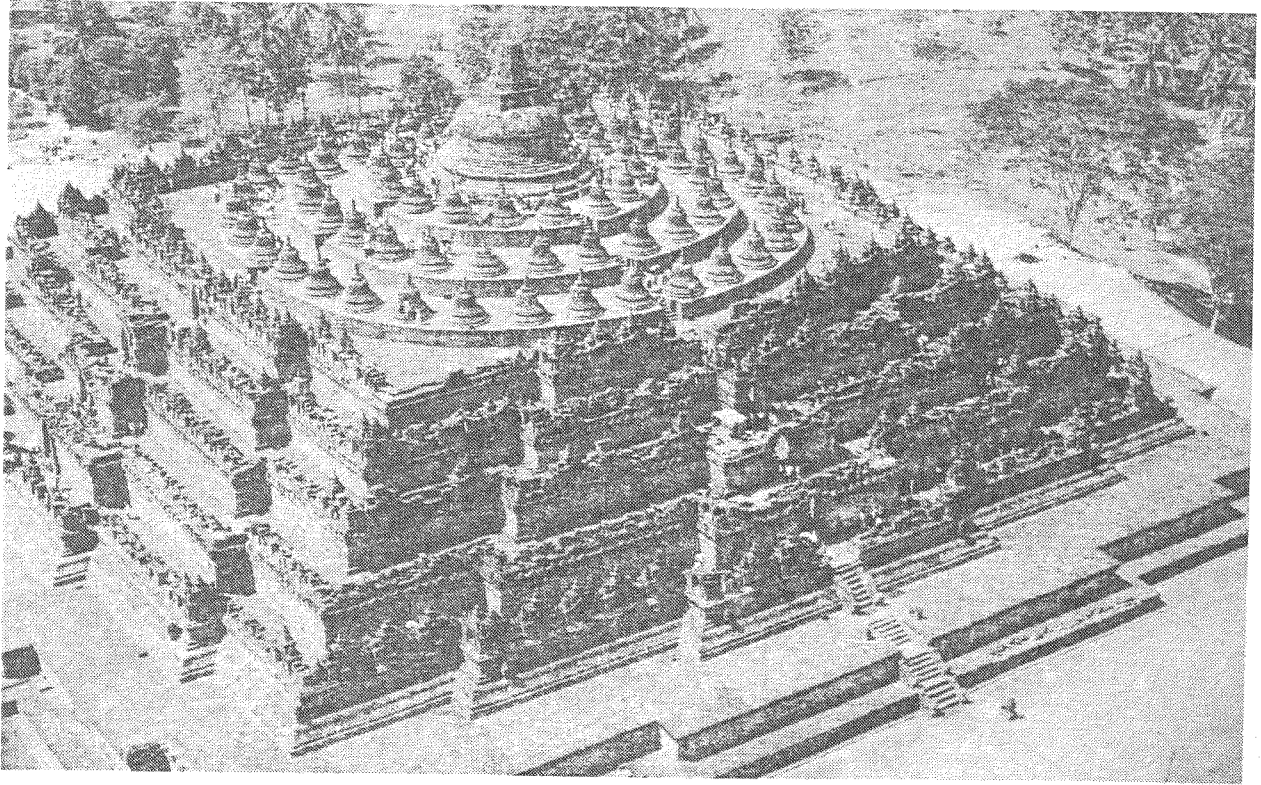
Borobudur is the largest of a triad of Buddhist temples in Java. Built in the eighth century, its design represents the ascension of man from the earthly sphere of desires, binding him to the endless cycles of reincarnation, to ultimate enlightenment and nirvana. Climbing the stairs to the top of the temple represents the path thru these various levels of consciousness.

Ascending levels or stages to enlightenment represent the three spheres of Buddhism, desire, form, and formlessness. In Figure H.2 these are Kamadhatu, Rupadhatu, and Arupadhatu, respectively. The bottom two levels, the Spheres of Desire and Form, are squares representing man's earthly existence. The top level is the Sphere of Formlessness representing heaven with a circular shape.

The design of the temple truly is magnificent. As the visitor ascends the steep steps to the top he passes by various reliefs

telling the story of Buddha. These reliefs are all on the two lower earthly levels. When the top level of Formlessness is reached and the design become circular there is a very different feeling. The "top-of-the-world" view and circular arrangement of the 72 closed stupas gives the visitor the sense of being one step closer to heaven than on the lower levels. The feeling of peace and serenity at the top reveals the designers intent in using smooth curves in an open arrangement. With the clever design the builders ingeniously impart to the visitor a feeling of higher consciousness transcending earthly existence. On this level no words are needed. No pictures or sounds could improve the message of enlightenment. The elegant simplicity of design is all that is needed, making Borobudur a true masterpiece.

The geometry and numbers in Borobudur should be familiar to the reader. The two square lower levels surround the circular top level. The two lower levels contain 432 ( $144 \times 3$ ) statues of Buddha in open niches. The circular top level contains 72 Buddha in closed stupa, a number that should be very familiar with the reader. This makes a total of 504 Buddha, or  $360 + 144$ . The 72 stupa at the top level are arranged in four quadrants of 18 each. This exact arrangement was used with the Uranus cycle moving  $72^\circ$  outlining 17-year cycles and subdividing into four 18-degree cycles.

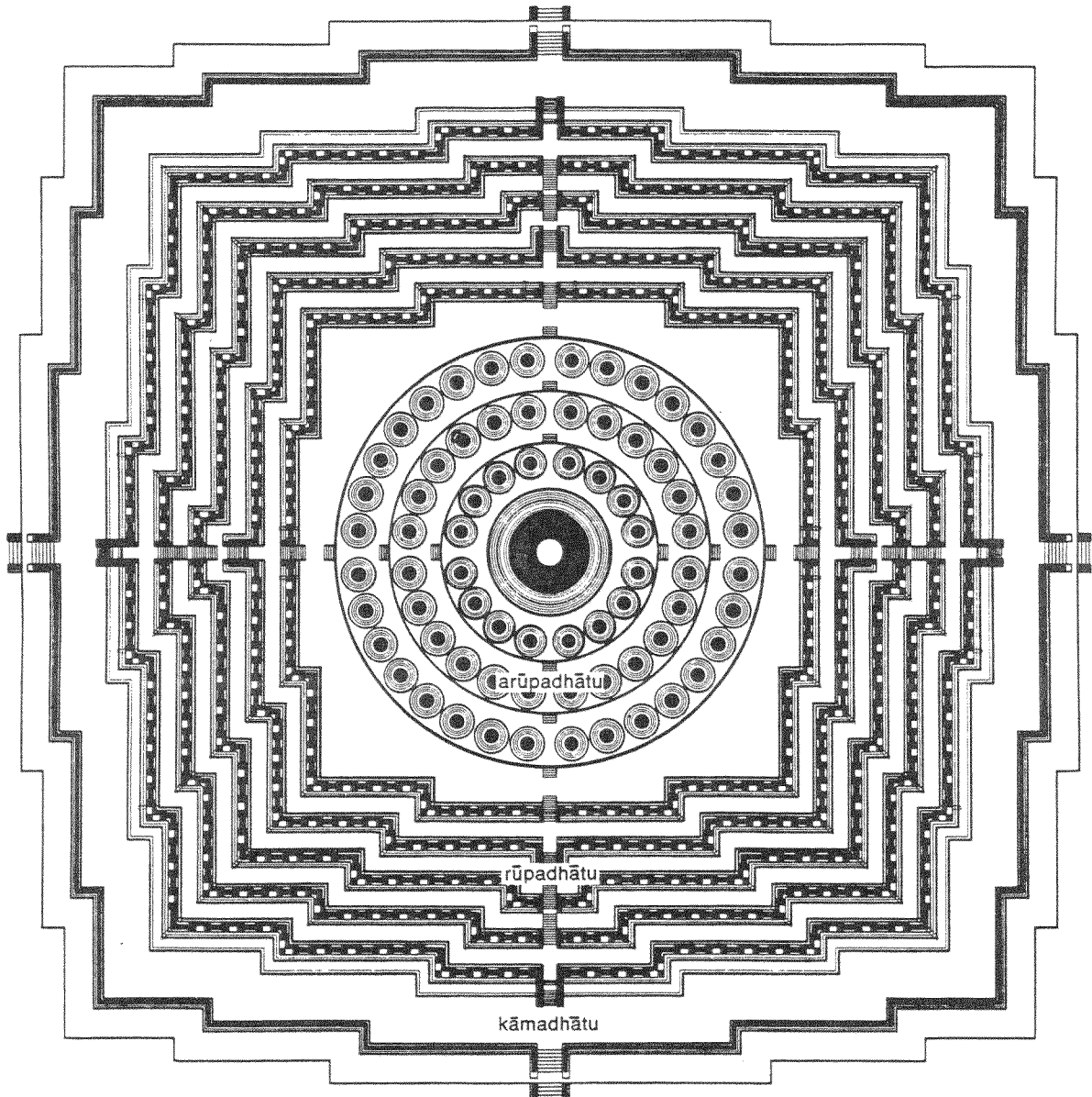


**Figure H.1**

Borobudur, Indonesia. Reprinted from *Magnificence of Borobudur*, Larisa

The reader is encouraged at some point in his life to take the time to visit a few ancient temples. It can be a very eye-opening experience into the thought process of those who came before us. Study the temple before visiting so when experiencing it in person the true intent of the builders is better

understood. There is no better temple to visit than Borobudur. Just be sure to also bring along mosquito repellent, a hat, and a lot of drinking water for the hot tropical climate.



**Figure H.2**  
 Borobudur layout showing the three levels of consciousness.  
 Reprinted from *Borobudur*, Yazir Marzuki and Toeti Herary



## Appendix I

## Uranus Quarter-Cycle Stock Market Update

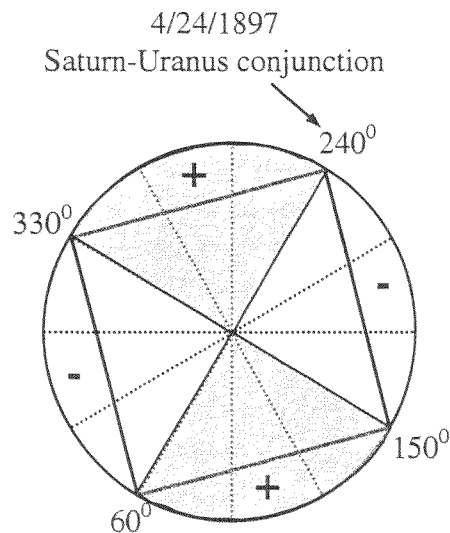
Charts VIII.A and VIII.B in *Four-Dimensional Stock Market Structures And Cycles* presented a  $90^\circ$  Uranus quarter-cycle in the stock market defining a trend of alternating polarity averaging 21 years. This cycle repeated from the birth of the New York Stock Exchange in May 1792 through September 1993.

The Uranus quarter-cycle is now updated to 2009 showing that it has continued to work very well for the 16 years since the original publication in 1993.

Figure I.1 shows the complete 84-year Uranus cycle of  $360^\circ$  with alternating polarity. The  $0^\circ$  point is the traditional zodiac origin of Aries. Each quarter-cycle is associated with rising prices in the positive phase and declining prices in the negative phase.

The square aligned with the Great Conjunction in 4/25/1897 at  $237^\circ$ , a point on the Great Pentagram.

Because Uranus moves in an elliptical path the quarter-cycles are not exactly 21 years each ( $84/4$ ). The bottom-to-bottom cycles tend to be 40, 44, 40, 44, etc years. It is extremely important to be aware of this variation because it aligns the Uranus cycle with the cycles of Saturn and Jupiter. The Jupiter-Saturn synodic cycle is 20 years, so one Jupiter-Saturn cycle corresponds with one Uranus quarter-cycle when the speed of Uranus is in the 40-year bottom-to-bottom phase. Chart I.2 shows examples of these 20 year periods between 1942-1962-1982-2003, represented by one Uranus quarter-cycle and one Jupiter-Saturn synodic cycle.



**Figure I.1**  
Uranus quarter-cycle averaging  
21 years of alternating polarity.

The Saturn-Uranus synodic cycle is approximately 45 years. This corresponds with one Uranus half-cycle, bottom-to-bottom, when Uranus is moving at that speed, such as 1813-1857, and 1982-2026.

### **UPDATE THE URANUS QUARTER CYCLE TO JANUARY 2009**

The top chart of Chart I.2 shows the trend was projected to a top in 2003, as had occurred in 1962 and 1919. The bottom chart shows this cycle also topped in 1877 and 1835.

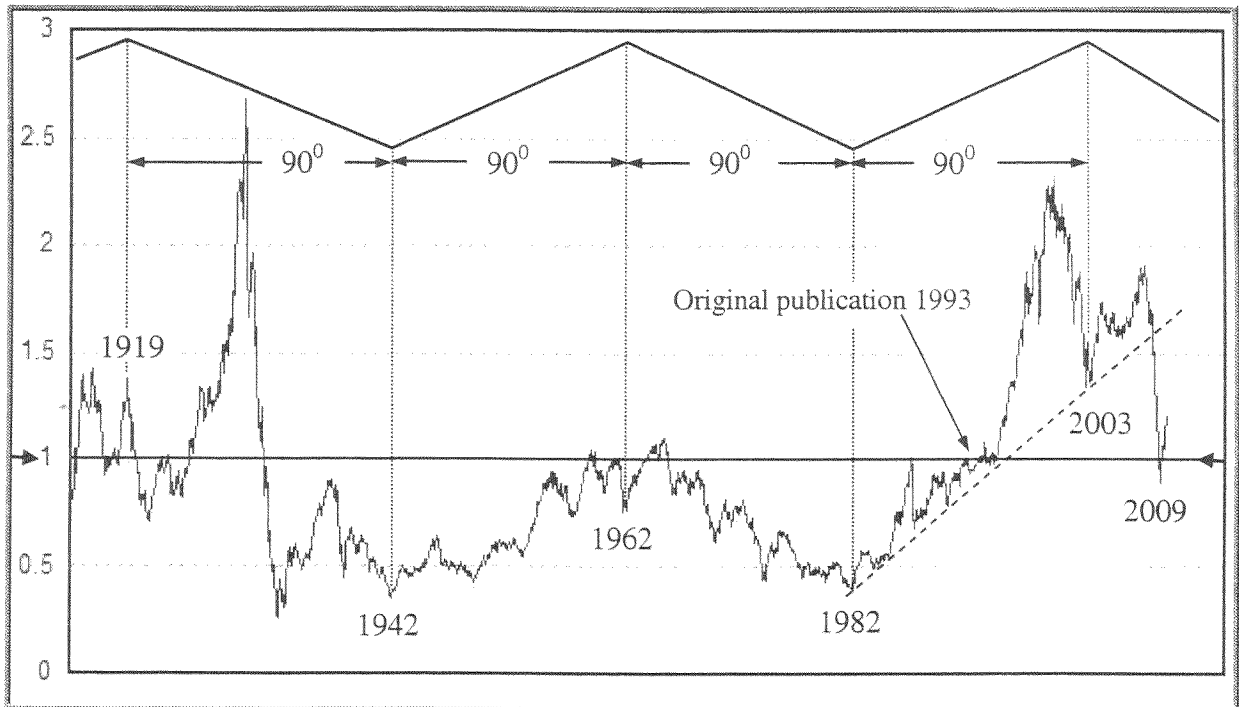
The updated Chart I.1 shows how well this cycle defined the trend after the September 1993 original publication date, continuing up until prices collapsed into the reversal date of 2003, right on schedule.

The formation of the reversal top was the same as at the 1962 and 1877 tops with prices advancing into the axis and abruptly dropping when the actual axis date was crossed.

Also notice on Chart I.1 that the price drop into 2003 stopped right on the trend line originating at the 1982 bottom. This trend line does not show on a chart without the exponential trend removed.

The value of "1" on the y-axis is met when the price data exactly matches the long-term exponential trend equation. This has had special significance since this trend first began growing in 1914. Look closer at the 1937 top, the multiple tops in the late 1950s and 1960s, the top in 1987, the breakout at the 1995 bottom, and the more recent 2009 bottom. All were right on this trend line.

Chart I.3 uses compressed weekly charts to update the Uranus quarter-cycle to 2003.  $180^{\circ}$  Uranus is measured from the previous quarter-cycle top in 1962. The two charts on the bottom use daily data to zoom in for a closer view.



**Chart I.1**

Update of *Four-Dimensional Chart VIII.B* thru October 2009, Uranus quarter-cycle.

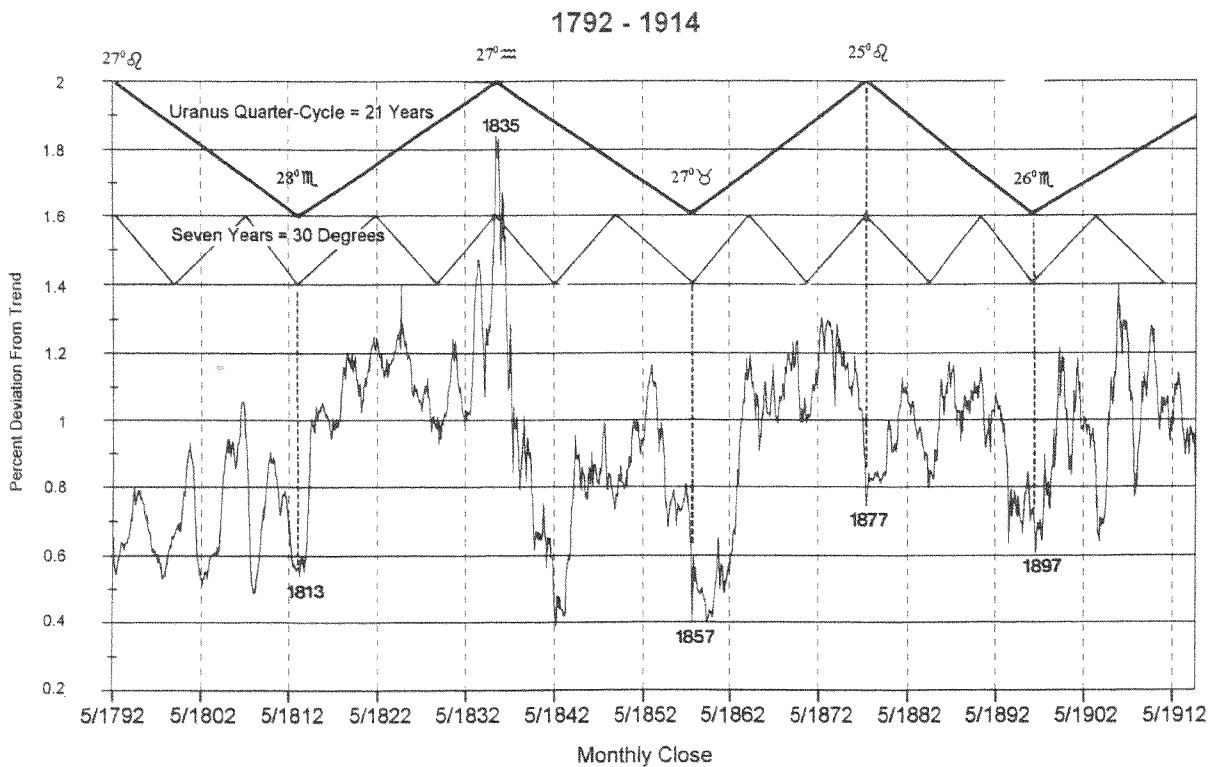
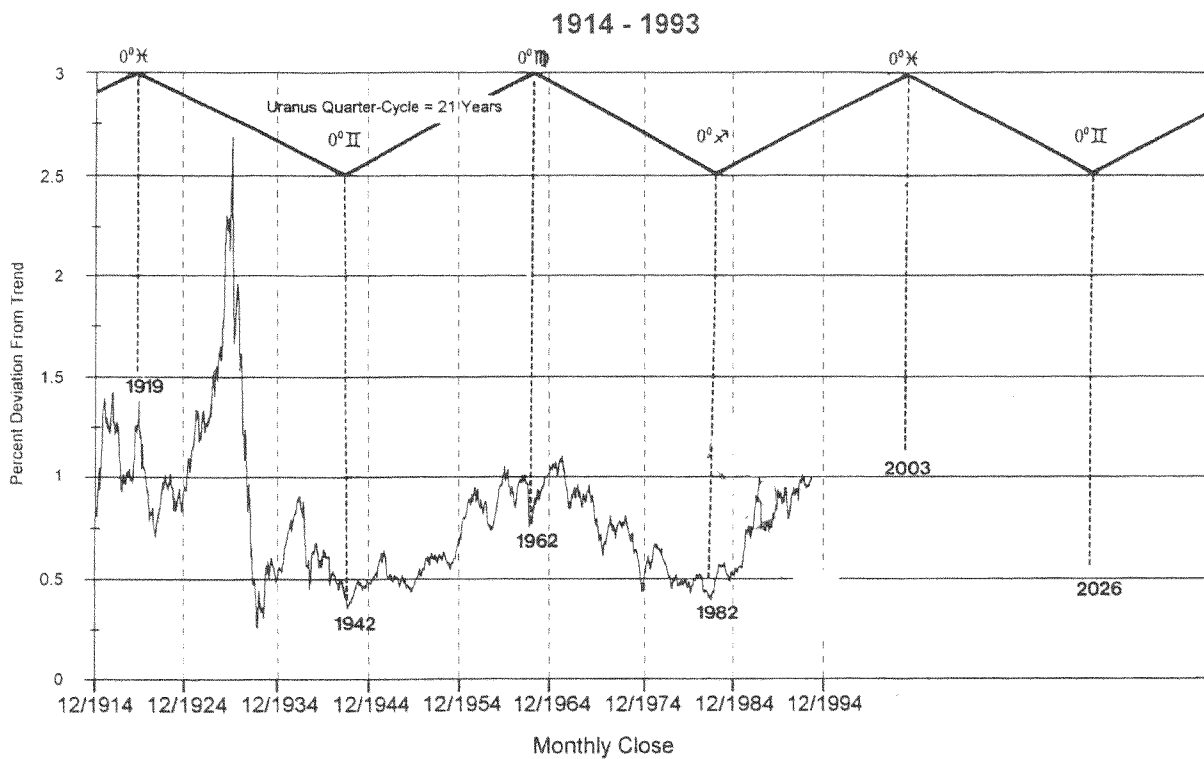


Chart I.2

Charts VIII.A and VIII.B from *Four-Dimensional Stock Market Structures And Cycles*.

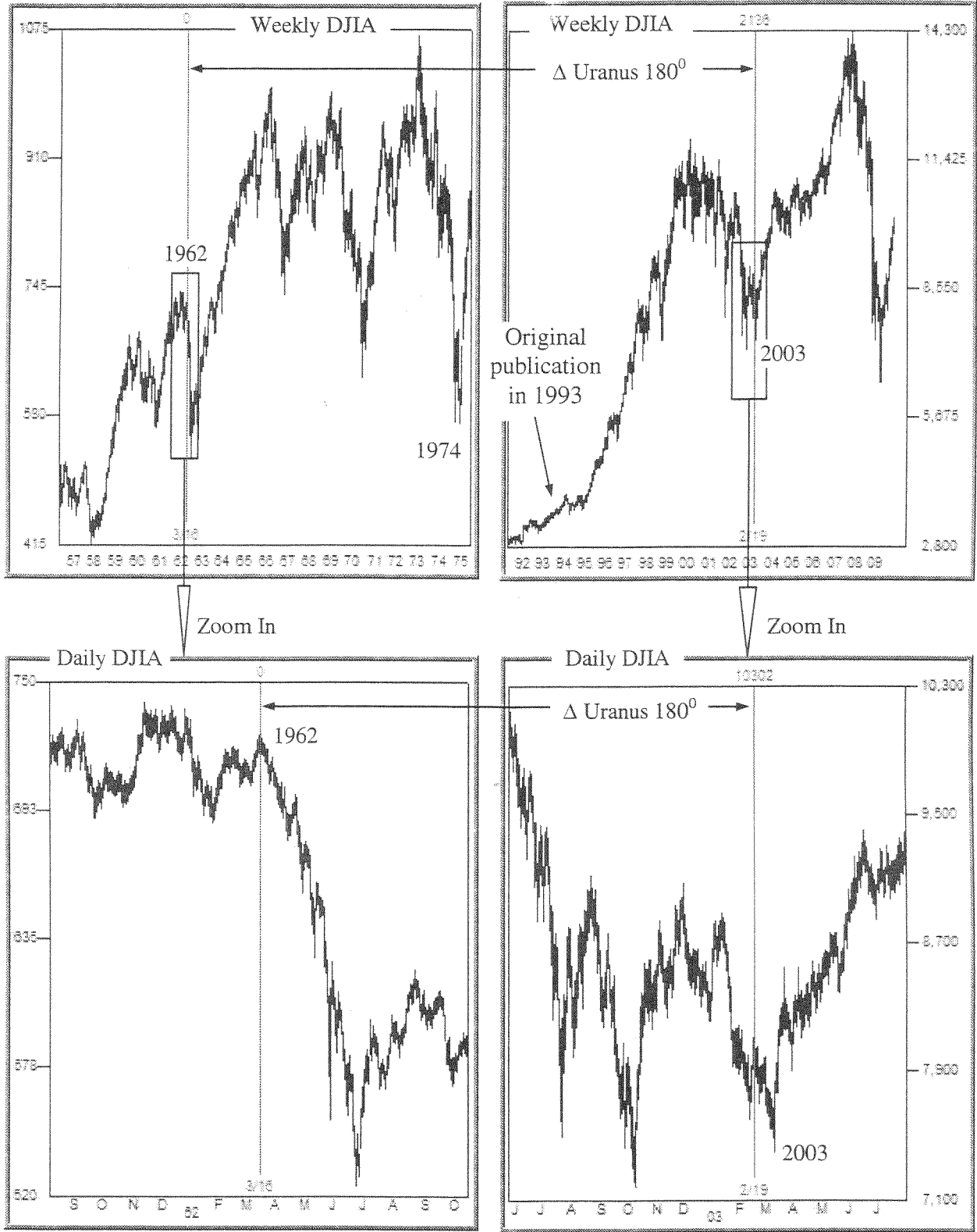


Chart I.3

Uranus quarter-cycle update to 2003.

## Appendix J

## Uranus Trine Soybean Cycle Update

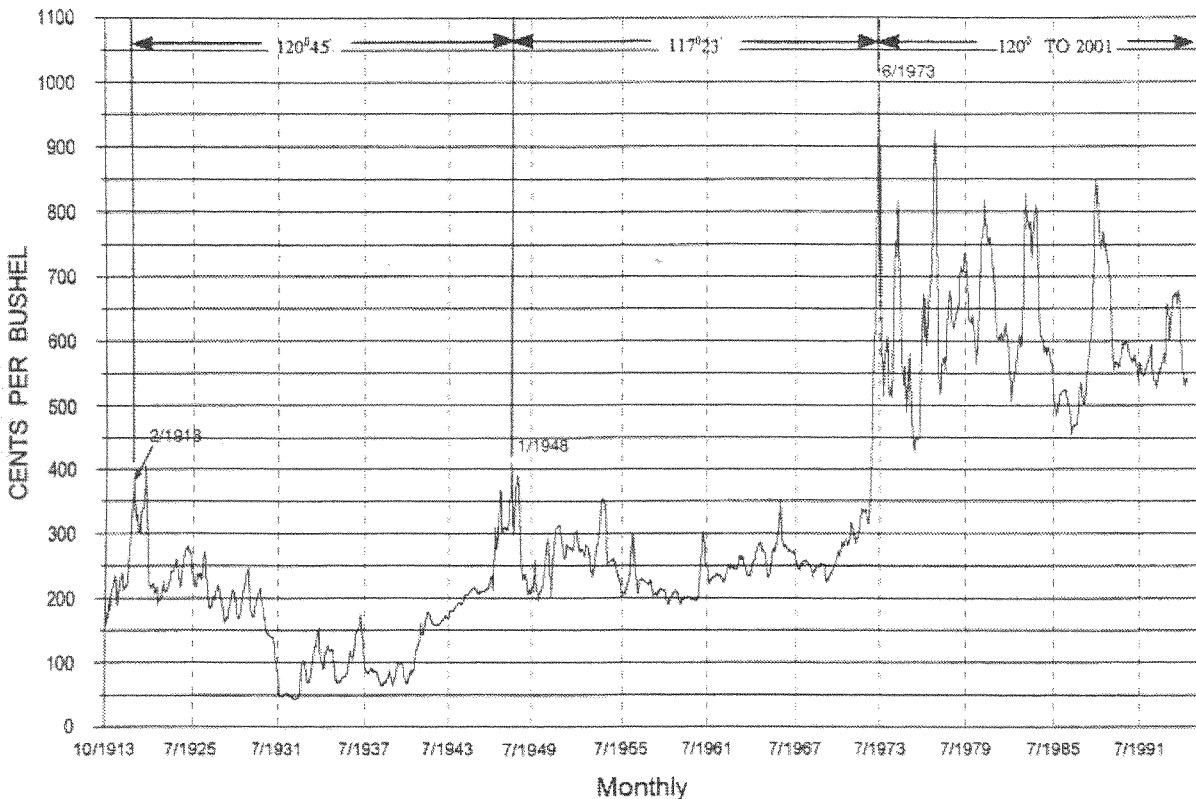
In 1995 *Market Science Volume II* published a forecasted cycle turn due in 2001 correlated with the  $120^{\circ}$  Uranus cycle. The chart from that book is reproduced here in Chart J.1.

Although the soybean market has never been a major interest of this author it was included to introduce the non-linear techniques in *Market Science* to show that the tools can be applied to any market. The

basic technique from *Four-Dimensional Stock Market Structures And Cycles* of measuring harmonic increments from tops and bottoms found the  $120^{\circ}$  Uranus cycle to be a dominant soybean cycle. Major turning points occur  $60^{\circ}$  apart.

Chart J.2 updates the soybean data to 2009 to show what happened in the 14 years after the *Market Science* publication. The market moved sideways in choppy action until 2001

**CHART XV.A**  
URANUS TRINE AND SOYBEAN TOPS



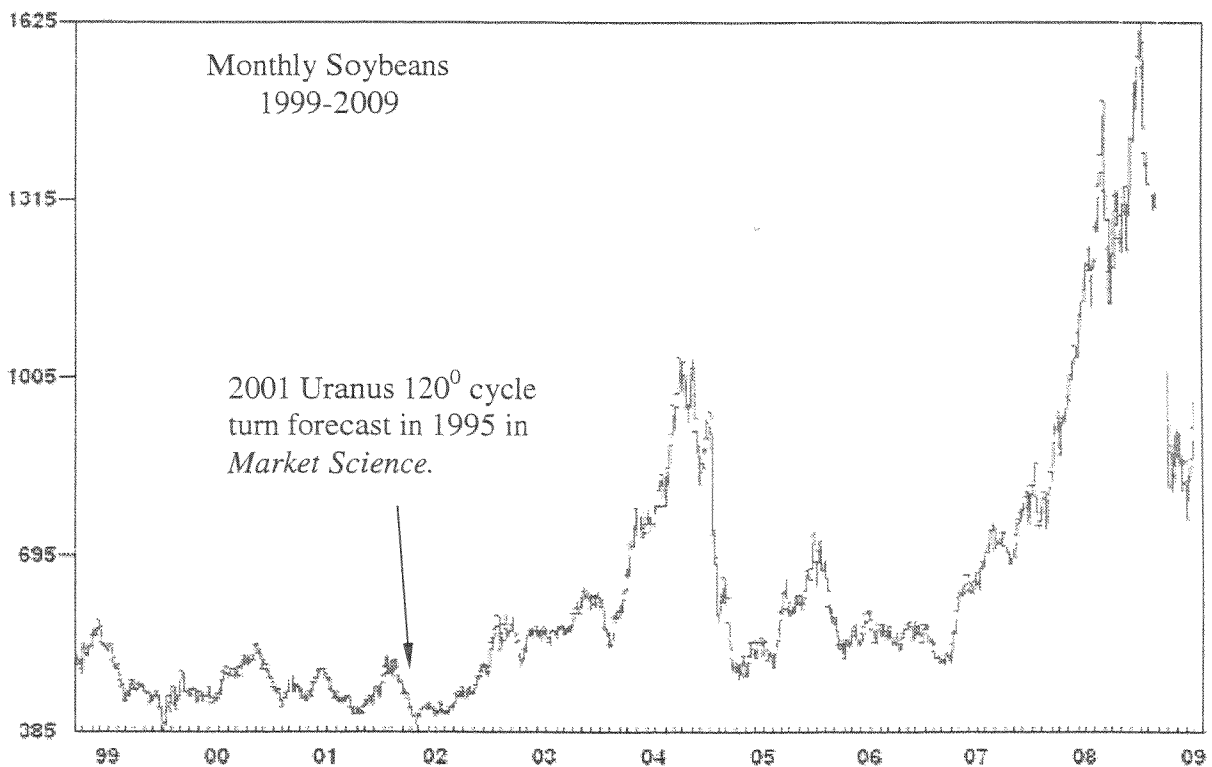
### Chart J.1

Forecasted 2001 cycle turn. Originally published in 1995.  
Reproduced from *Market Science*.

when it took off like a rocket more than doubling in two years, pulled back, then quadrupled to over 1600 in 2008, one 7-year cycle from the 2001 bottom.

the cycle arrived as a bottom, establishing his long positions thereafter. The result was exactly as published in 1995, "producing a once-in-a-lifetime opportunity".

For teaching purposes the original forecast identified the Uranus cycle as a simple triangle wave. Most experienced traders know that markets rarely follow this idealized waveform. Tops often become bottoms and vice versa. 2001 was no exception coming in as a major bottom instead of top. For the experienced trader whether it was a top or bottom is irrelevant. In 2002 he would have watched the preceding market behavior and known that



**Chart J.2**

Update of forecasted 2001 cycle turn in soybeans originally published in 1995.

The following article was written by Bradley F. Cowan and published in *Traders World Magazine* in the Spring 2003 Issue #35.

### Cowan Astro Cycles Provide A New Approach To An Old Science

If you have ever been curious about how planetary cycles can be used to forecast market trends, but gave up after looking at the astrology books, you are not alone. All those strange symbols and terminology like orbs, houses, rulerships, and transits can be very intimidating. And most people do not want to spend years getting a PhD in Astrology to find a reliable indicator of trend duration. Like most traders using astro techniques, I started with the classical approach, but soon discovered that by applying a few simple rules you can forecast the timing of market turns quite accurately without needing to know all the details of astrology textbooks.

Simply stated, all you need to do is follow a 3-step process:

- (1) Find a clearly identifiable top or bottom on a chart.
- (2) Find locations of planets on that date. (Software does this for you)
- (3) Make time projections by adding multiples of 30 degrees to locations in (2). (Software does this for you)

Where this technique differs from classical Astrology is that I do not care what the angles between the planets are at the tops or

bottoms, just the distance they travel between two turning points. Classical Astrology tells us to expect changes when two planets are at certain predefined angles of separation. Traditionally, these are 30, 45, 60, 90, 120, and 180 degrees. But it seemed a bit arrogant to me to be telling God that he should do something on our schedule. So I looked instead at what the market was telling us, at where the planets are at the tops and bottoms and use THAT angle as our starting point, regardless of its value. It's really a simple process that I have successfully applied to my trading for more than 20 years.

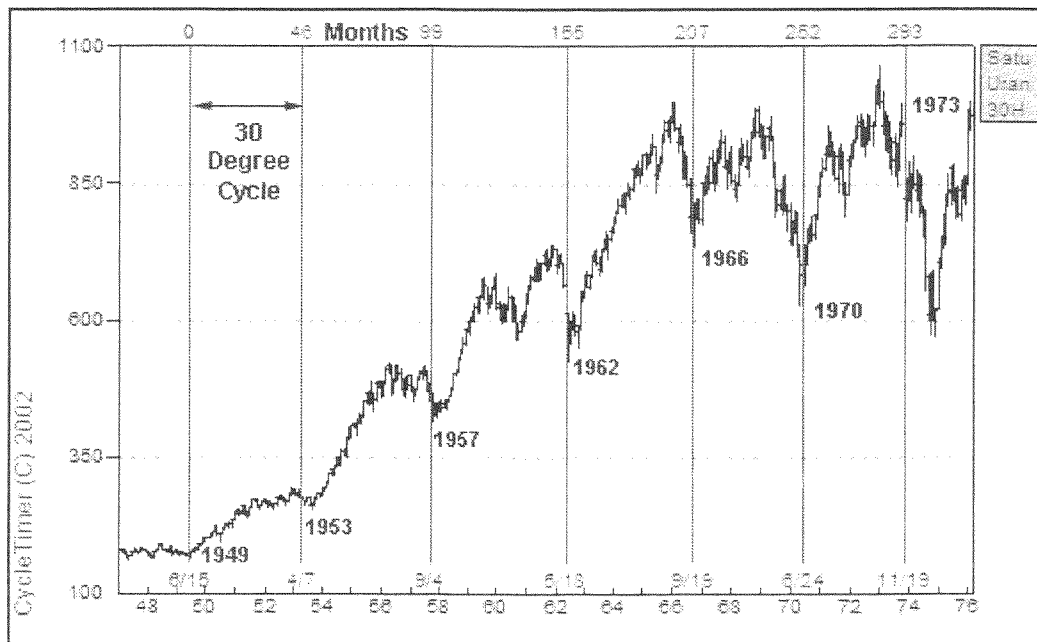
As an example, we will look at a compressed weekly chart of the DJIA from 1949 to 1975, shown in Figure 1.

Applying the 3-step process:

Step 1 – Find a major bottom or top.

Anytime after 1950 the bottom in 1949 would have been easy to identify as a major bottom, so that will be used as our starting point.

Step 2 – Find the locations of the planets at the date in Step 1 (1949).



**Figure 1**

30-degree heliocentric movement of Saturn relative to Uranus in the DJIA

An ephemeris is used to find the locations of the planets, or there are several software programs that will do the same. All calculations, projections, and charts in this article were made with CycleTimer.

Because this is a long-term weekly chart, the major cycles will correspond with the 3 slower moving outer planets Jupiter, Saturn, and Uranus. If we were working with a daily chart then the faster inner planets, Mars, Venus, Mercury would be used.

Experience has taught that most markets have a strong cycle closely correlated with the heliocentric (viewed from the sun) movement of Saturn relative to Uranus. CycleTimer shows that at the bottom in 1949 the location of Saturn was 66 degrees from Uranus, so that is the cycle origin from which our future cycle dates are projected.

Step 3 – Add 30, 60, 90, etc degrees to the location in Step 2 (66 degrees).

Adding 30-degree increments to 66 produces 96, 126, 156, etc. CycleTimer calculates and plots in Figure 1 the dates that Saturn and Uranus were separated by these angles. Six instances of this cycle are shown, or a full 180 degrees. You can see that this cycle closely corresponded with major bottoms at every instance. Classical Astrological techniques do not identify this cycle because it does not coincide with their predefined angles of 60, 90, 120, and 150 degrees.

To improve the probability that your cycles projected into the future are accurate, be sure that at least three instances have occurred in your historical data, not including the starting point. If you have less than three occurrences of the cycle move your starting point back in time until you have at least three. And more importantly, be sure that you have no more than one or two “false positives”, that is, a cycle that arrives with no significant trend change. If



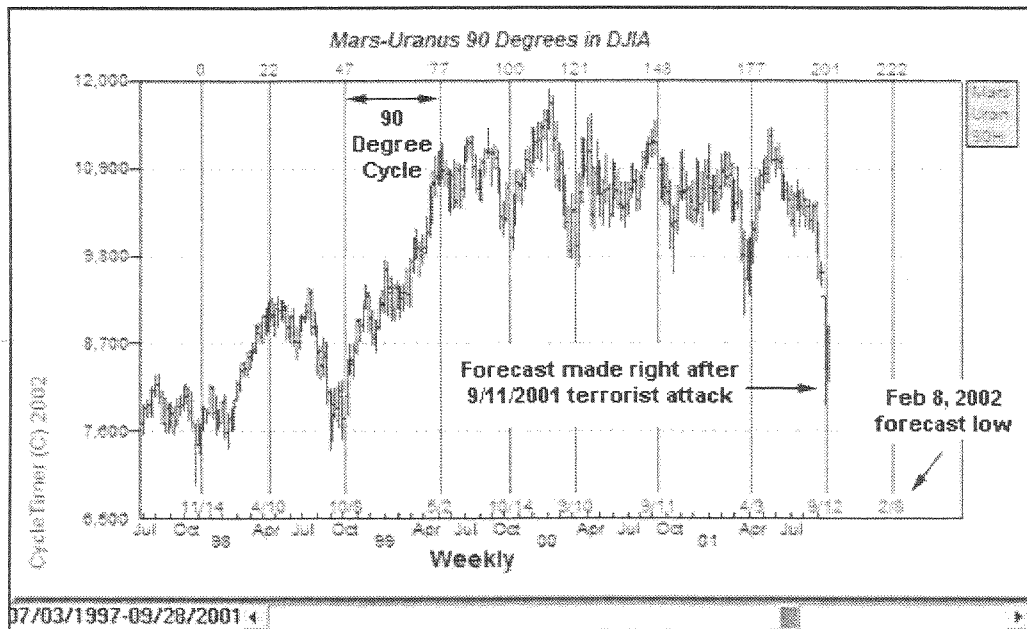
you follow these rules you will have a high probability that your projected cycle dates will be correct and you can expect a reversal of trend very near that date.

Figure 2 shows an example of how I used this 3-step technique to make a real-time forecast in October 2001 for a trend reversal in February 8. Part A is a copy of the chart I posted on the Internet in October 2001. Part B shows how the forecast turned out.

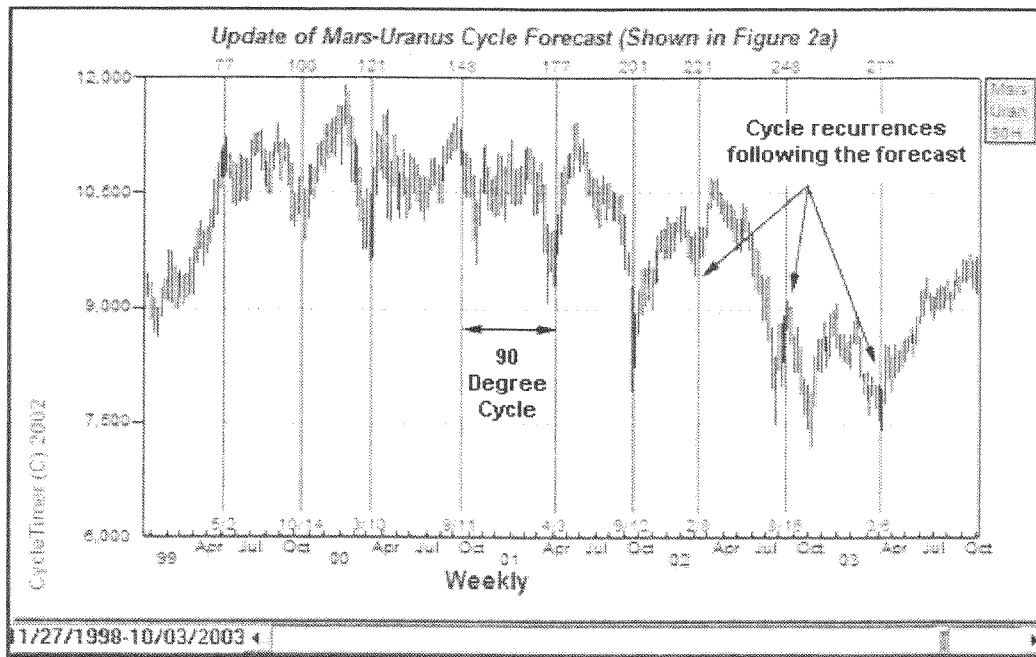
This cycle uses heliocentric 90-degree movements of Mars relative to Uranus. Following the 3-step process and using a cycle start date at the low of November 1997, produces a cycle where all eight

recurrences coincided with significant market turns. Therefore, there was a high probability that the next recurrence in the future would also mark a turn.

Figure 2b shows what happened. On February 8 the DJIA bottomed and began an advance of 1100 points, or 11%, in one month. This is another cycle that classical Astrologers would have missed because the angles between Mars and Uranus for this cycle are 7, 83, 173 degrees, which are not any of the classical predetermined angles



**Figure 2a**  
90-degree heliocentric movement of Mars relative to Uranus used to forecast cycle low in DJIA



**Figure 2b**

Cycles arriving after the forecast was made were highly accurate.

### *Nesting Cycles Amplify Their Net Effect*

When you gain more experience using this technique you will be able to watch more than one cycle at a time, which makes sense because there are more than two planets in the Solar System. These multiple cycles can either interfere with each other if they arrive at different times, or reinforce each other if they arrive at the same time. If two or more cycles bottom closely together (nest) they reinforce each other and their net effect is amplified. The result is a sharp panicky sell off followed by a quick recovery producing a “V” or “trauma” bottom.

Figure 3 shows how I used the technique of nesting cycles to accurately forecast almost one year in advance the June-July 2002 sell off and bottom in stocks. This chart was also posted on the Internet in October 2001.

To keep the technique simple the cycle start dates were taken out of the textbook *Four-Dimensional Stock Market Structures And Cycles* and extrapolated into the future using CycleTimer software. The entire projection process took less than one minute.

The Saturn-Uranus cycle we studied earlier during the 1949-1975 period is again used with the origin set at the major low of November 1994. The second cycle is another that has historically produced reliable results, the movement of Jupiter relative to Uranus, or the Jupiter-Uranus cycle. The crash low of October 1987 was used for the origin of the Jupiter-Uranus cycle because it has produced a cycle that has repeated dependably for the last 15 years.

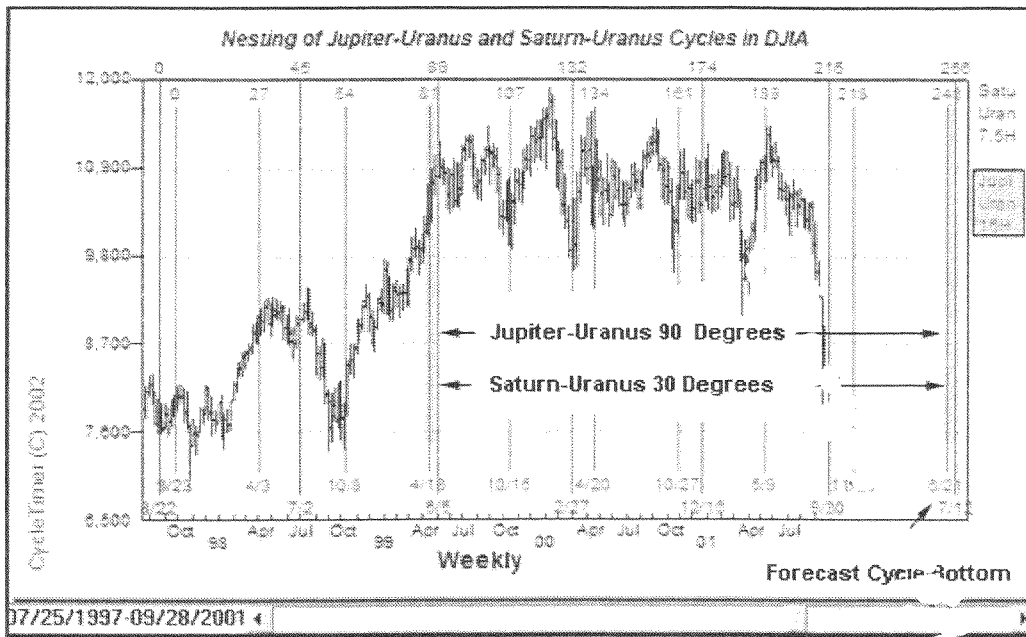


Figure 3a

Two cycles arriving simultaneously allowed this forecast to be accurately made one year in advance.

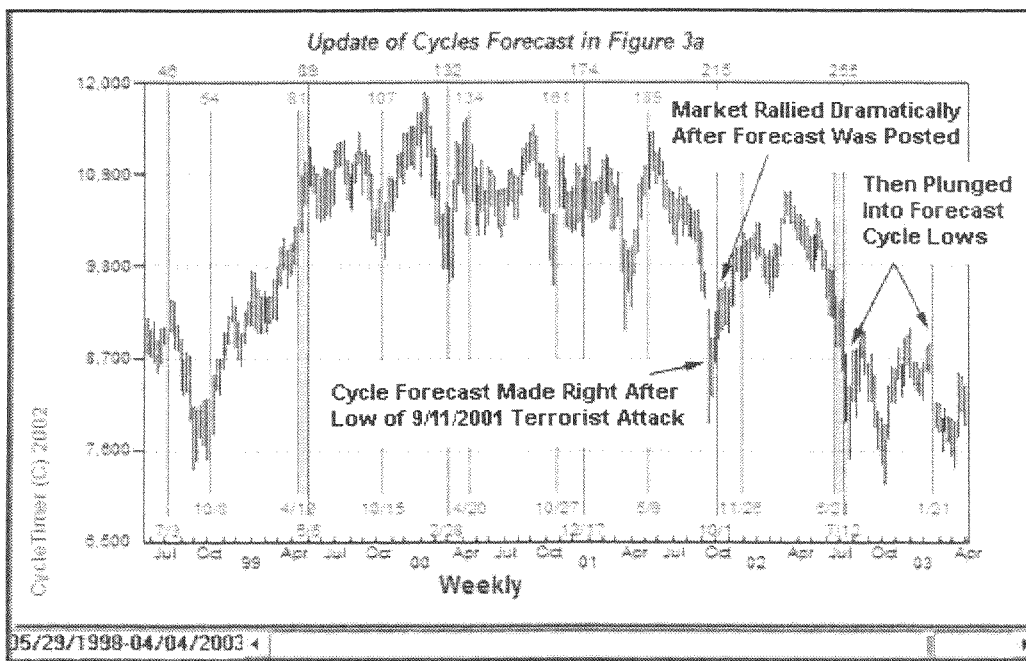


Figure 3b

This chart updates the DJIA data after the forecast shown in Figure 3a. CycleTimer accurately forecast the panic selling in July, 2002 and January.

When CycleTimer projected these two cycles into the future it showed them nesting (arriving at the same time) in late June-July producing a warning that this was a very high-risk time. The position trader would liquidate any remaining long positions he had before this high-risk time arrived and wait out the storm. So while many traders were panicking during the June-July sell off and wondering where the bottom was, my confidence in the cycle locations allowed me to enjoy a two-month island hopping vacation in Indonesia, Thailand, and Cambodia, scuba diving and studying the ancient temples, as my profits accrued.

### *Works For Daytrading Too*

The same 3-step technique works intraday. The major difference between intraday timing and end-of-day is that intraday uses the rotation of the Earth instead of the orbits of the planets. This increases the complexity a little bit because you not only want to watch the smaller cycles but the larger ones as well. A few small cycles arriving intraday will not affect the market much if it is in a strong trend caused by a large cycle. So work with the larger cycles first before moving into intraday.

## *The Author*

Bradley F. Cowan is a full-time trader and author of several market-timing books.

He is a retired Electrical Engineer that specialized in microprocessor based control systems. He worked as a consultant on a variety of civilian and classified military projects including the Seawolf attack submarine, the FA-18 fighter aircraft, global positioning satellites, Sparrow missile, and others.



## *Recommended Reading*

- Four-Dimensional Stock Market Structures And Cycles*, Cowan, [www.cycle-trader.com](http://www.cycle-trader.com)
- Market Science Volumes I & II*, Cowan, [www.cycle-trader.com](http://www.cycle-trader.com)
- Rare Writings of WD Gann*, [www.cycle-trader.com](http://www.cycle-trader.com)
- WD Gann Master Course for Stocks*, [www.cycle-trader.com](http://www.cycle-trader.com)
- WD Gann Master Course for Commodities*, [www.cycle-trader.com](http://www.cycle-trader.com)
- Tides in the Affairs of Men*, Edgar Lawrence Smith (1939), *The Macmillan Company (New York)*
- The Theoretic Arithmetic of the Pythagoreans*, Thomas Taylor
- Time Stands Still*, Keith Critchlow. 1982, ISBN 0-312-80514-4
- The Divine Proportion: A Study in Mathematical Beauty*, 1970, Dover Publications, ISBN 0486222543
- Connections – The Geometric Bridge Between Art and Science*, Jay Kappraff, (1990), McGraw-Hill
- Curves of Life*, Theodore Andrea Cook, (1979), Dover Publications, ISBN 0-486-23701-X
- Cycles*, Dewey, (1971), Hawthorn Books, Library of Congress 70-130730
- Elements of Dynamic Symmetry*, Jay Hambridge
- Geometry of Art and Life*, Matila Ghyka, (1977), Dover Publications, ISBN 0-486-23542-4
- Kepler's Geometrical Cosmology*, (1988), J.V. Field, University of Chicago Press, ISBN 0-226-24823-2
- Sacred Geometry*, Robert Lawlor, (1989), Thames & Hudson, ISBN 0-500810303
- Tertium Organum*, Petyr Demianovich Ouspensky
- Our Cosmic Ancestors*, Maurice Chatelain
- The Cycles of Heaven*, Guy Playfair and Scott Hill
- Celestial Navigation For Yachtsmen*, 1964, Mary Blewitt
- Celestial Navigation in a Nutshell*, 2000, Hewitt Schlereth
- The Sextant Handbook*, 1986, Bruce Bauer